

# Creta

## OWNER'S MANUAL

Operation  
Maintenance  
Specifications

All information in this Owner's Manual is current at the time of publication. However, HYUNDAI reserves the right to make changes at any time without prior notice and without obligation to incorporate such changes so that our policy of continual product improvement may be carried out.

This manual applies to all models of this vehicle and includes descriptions and explanations of optional as well as standard equipment. As a result, you may find material in this manual that does not apply to your specific vehicle.

This booklet is not intended to be a substitute for the Owner's Manual given in QR Code provided at the backside of the cover page.

## CAUTION: MODIFICATIONS TO YOUR HYUNDAI

Your HYUNDAI should not be modified in any way. Such modifications may adversely affect the performance, safety or durability of your HYUNDAI and may, in addition, violate conditions of the limited warranties covering the vehicle. Certain modifications may also be in violation of regulations established by the Department of Transportation and other government agencies in your country.

## TWO-WAY RADIO OR CELLULAR TELEPHONE INSTALLATION

Your vehicle is equipped with electronic fuel injection and other electronic components. It is possible for an improperly installed/adjusted two-way radio or cellular telephone to adversely affect electronic systems. For this reason, we recommend that you carefully follow the radio manufacturer's instructions or consult your HYUNDAI dealer for precautionary measures or special instructions if you choose to install one of these devices.

## SAFETY AND VEHICLE DAMAGE WARNING

This manual includes information titled as DANGER, WARNING, CAUTION and NOTICE.

These titles indicate the following:



### **DANGER**

**DANGER** indicates a hazardous situation which, if not avoided, will result in death or serious injury.



### **WARNING**

**WARNING** indicates a hazardous situation which, if not avoided, could result in death or serious injury.



### **CAUTION**

**CAUTION** indicates a hazardous situation which, if not avoided, could result in minor or moderate injury.

### **NOTICE**

**NOTICE** indicates a situation which, if not avoided, could result in vehicle damage.

# Table of Contents

Hyundai Warranty Policy	1
Vehicle Information	2
Seats & Safety System	3
Instrument Cluster	4
Convenience Features	5
Driving Your Vehicle	6
Driver Assistance System	7
Emergency Situations	8
Maintenance	9

## FOREWORD

Thank you for choosing HYUNDAI. We are pleased to welcome you to the growing number of discriminating people who drive HYUNDAI. The advanced engineering and high-quality construction of each HYUNDAI we build is something of which we're very proud.

Your Owner's Manual will introduce you to the features and operation of your new HYUNDAI. It is suggested that you read it carefully because the information it contains can contribute greatly to the satisfaction you receive from your new car.

The manufacturer also recommends that service and maintenance on your vehicle be performed by an authorized HYUNDAI dealer.

## HYUNDAI MOTOR COMPANY

**Information** : Because future owners will also need the information included in this manual, if you sell this HYUNDAI, please leave the manual in the vehicle for their use. Thank you.



### CAUTION

Severe engine and transmission damage may result from the use of poor quality fuels and lubricants that do not meet HYUNDAI specifications. You must always use high quality fuels and lubricants that meet the specifications listed on Page 2-13 in the Vehicle Specifications section of the Owner's Manual.

Copyright 2023 HYUNDAI Motor Company. All rights reserved. No part of this publication may be reproduced, stored in any retrieval system or transmitted in any form or by any means without the prior written permission of HYUNDAI Motor Company.

## FUEL REQUIREMENTS

### Gasoline engine

#### Unleaded

Your new vehicle is designed to perform optimally using unleaded fuel having an Octane Rating of RON (Research Octane Number) 91/AKI (Anti-Knock Index) 87 or higher. (Do not use methanol blended fuels)

Your new vehicle is designed to obtain maximum performance with UNLEADED FUEL, as well as minimize exhaust emissions and spark plug fouling.

#### **NOTICE**

##### NEVER USE LEADED FUEL

The use of leaded fuel is detrimental to the catalytic converter and will damage the engine control system's oxygen sensor and affect emission control.

Also, severe wear and crack of piston ring, valve, etc. may occur and knocking noise may be heard from your engine.

Never add any fuel system cleaning agents to the fuel tank other than what has been specified (We recommend that you consult an authorized HYUNDAI dealer for details.)



#### **WARNING**

- Do not "top off" after the nozzle automatically shuts off when refueling.
- Always check that the fuel cap is installed securely to prevent fuel spillage in the event of an accident.

## Gasoline containing alcohol and methanol

Gasohol, a mixture of gasoline and ethanol (also known as grain alcohol), and gasoline or gasohol containing methanol (also known as wood alcohol) are being marketed along with or instead of leaded or unleaded gasoline.

Do not use gasohol containing more than 20% ethanol, and do not use gasoline or gasohol containing any methanol. Either of these fuels may cause drivability problems and damage to the fuel system, engine control system and emission control system.

Discontinue using gasohol of any kind if drivability problems occur.

Vehicle damage or drivability problems may not be covered by the manufacturer's warranty if they result from the use of:

1. Gasohol containing more than 20% ethanol.
2. Gasoline or gasohol containing methanol.
3. Leaded fuel or leaded gasohol.



### CAUTION

Never use gasohol which contains methanol. Discontinue use of any gasohol product which impairs drivability.

## Using Fuel Additives

Using fuel additives such as:

- Silicone fuel additive
- MMT (Manganese, Mn) fuel additive
- Ferrocene (iron-based) fuel additive
- Other metallic-based fuel additives

May result in cylinder misfire, poor acceleration, engine stalling, engine plugging, heavy knocking noise, damage to the catalyst, or abnormal corrosion, and may cause damage to the engine resulting in a reduction in the overall life of the powertrain.

### NOTICE

Damage to the fuel system or performance issues caused by the use of these fuels or fuel additives may not be covered by your New Vehicle Limited Warranty.

## Use of MTBE

HYUNDAI recommends avoiding fuels containing MTBE (Methyl Tertiary Butyl Ether) over 15.0% vol. (Oxygen Content 2.7% weight) in your vehicle.

Fuel containing MTBE over 15.0% vol. (Oxygen Content 2.7% weight) may reduce vehicle performance and produce vapor lock or hard starting.



### CAUTION

Your New Vehicle Limited Warranty may not cover damage to the fuel system and any performance problems that are caused by the use of fuels containing methanol or fuels containing MTBE (Methyl Tertiary Butyl Ether) over 15.0% vol. (Oxygen Content 2.7% weight.)

## Do not use methanol

Fuels containing methanol (wood alcohol) should not be used in your vehicle. This type of fuel can reduce vehicle performance and damage components of the fuel system, engine control system and emission control system.

## Using Fuel Additives

HYUNDAI recommends that you use unleaded gasoline which has an octane rating of RON (Research Octane Number) 95/AKI (Anti Knock Index) 91/AKI (Anti-Knock Index) 87 or higher. For customers who do not use good quality gasolines, and have problems starting or the engine does not run smoothly, one bottle of additive added to the fuel tank is recommended according to the maintenance schedule (refer to the "Normal Maintenance Schedule" section in chapter 9).

Additives are available from your authorized HYUNDAI dealer along with information on how to use them. Do not mix other additives.

### NOTICE

Never add any fuel system cleaning agents or other additives to the fuel tank other than what has been specified. We recommend that you contact a HYUNDAI authorised repairer for details.

## Operation in foreign countries

If you are going to drive your vehicle in another country, be sure to:

- Observe all regulations regarding registration and insurance.
- Determine that acceptable fuel is available.

## Diesel engine

### ***Diesel fuel***

Diesel engine must be operated only on commercially available diesel fuel that complies with EN 590 or comparable standard. (EN stands for “European Norm”). Do not use marine diesel fuel, heating oils, or non-approved fuel additives, as this will increase wear and cause damage to the engine and fuel system. The use of non-approved fuels and / or fuel additives will result in a limitation of your warranty rights.

Diesel fuel of above cetane 51 is used in your vehicle. If two types of diesel fuel are available, use summer or winter fuel properly according to the following temperature conditions.

- Above - 5°C (23°F) ... Summer type diesel fuel.
- Below -5°C (23°F) ... Winter type diesel fuel.

Watch the fuel level in the tank very carefully : If the engine stops through fuel failure, the circuits must be completely purged to permit restarting.



### **CAUTION**

**Do not let any petrol or water enter the tank. This would make it necessary to drain it out and to bleed the lines to avoid jamming the injection pump and damaging the engine.**



### **CAUTION**

**- Diesel Fuel (if equipped with DPF)**

**It is recommended to use the regulated automotive diesel fuel for diesel vehicle equipped with the DPF system. If you use diesel fuel including high sulfur (more than 10 ppm sulfur) and unspecified additives, it can cause the DPF system to be damaged and white smoke can be emitted.**



### ***Biodiesel***

Commercially supplied Diesel blends of no more than 7% biodiesel, commonly known as “B7 Diesel” may be used in your vehicle if Biodiesel meets EN 14214 or equivalent specifications. (EN stands for “European Norm”). The use of bio-fuels exceeding 7% made from rapeseed methyl ester (RME), fatty acid methyl ester (FAME), vegetable oil methyl ester (VME) etc., or mixing diesel exceeding 7% with biodiesel will cause increased wear or damage to the engine and fuel system. Repair or replacement of worn or damaged components due to the use of non approved fuels will not be covered by the manufactures warranty.



### **CAUTION**

- **Never use any fuel, whether diesel, B7 biodiesel or otherwise, that fails to meet the latest petroleum industry specification.**
- **Never use any fuel additives or treatments that are not recommended or approved by the vehicle manufacturer.**

## VEHICLE MODIFICATIONS

- This vehicle should not be modified. Modification of your vehicle could affect its performance, safety or durability and may even violate governmental safety and emissions regulations.

In addition, damage or performance problems resulting from any modification may not be covered under warranty.

- If you use unauthorized electronic devices, it may cause the vehicle to operate abnormally, wire damage, battery discharge and fire. For your safety, we recommend that you do not use unauthorized electronic devices.

### **NOTICE**

Some vehicle interior sounds (including welcome sound, navigation alerts, or warning sounds) may be generated from the interior speakers and amplifier. Do not replace these components with anything other than the original Hyundai factory parts. Any unauthorised product may cause a malfunction of the vehicle interior sounds that may affect the intended operation of the vehicle.

## VEHICLE HANDLING INSTRUCTIONS

As with other vehicles of this type, failure to operate this vehicle correctly may result in loss of control, an accident or vehicle rollover.

Specific design characteristics (higher ground clearance, track, etc.) give this vehicle a higher centre of gravity than other types of vehicles. In other words they are not designed for cornering at the same speeds as conventional 2-wheel drive vehicles. Avoid sharp turns or abrupt manoeuvres. Again, failure to operate this vehicle correctly may result in loss of control, an accident or vehicle rollover. Be sure to read the "Reducing the risk of rollover" driving guidelines, in chapter 6 of this manual.

## VEHICLE BREAK-IN PROCESS

By following a few simple precautions for the first 1,000 km (600 mi.) you may add to the performance, economy and life of your vehicle.

- Do not race the engine.
- While driving, avoid sudden acceleration.
- Do not maintain a single speed for long periods of time, either fast or slow. Varying engine speed is needed to properly break-in the engine.
- Avoid hard stops, except in emergencies, to allow the brakes to seat properly.
- Do not tow a trailer during the first 2,000 km (1,200 mi.) of operation.
- Fuel economy and engine performance may vary depending on vehicle break-in process and be stabilized after 6,000 km (4,000 mi.). New engines may consume more oil during the vehicle break-in period.



# 1. Hyundai Warranty Policy

Hyundai New Vehicle Warranty .....	1-2
Replacement Parts Warranty .....	1-3
Hyundai Extended Warranty .....	1-5
Labour Free Service of Vehicle .....	1-5
Hyundai Road Side Assistance .....	1-6
Labour Free Service Coupons.....	1-7

## HYUNDAI NEW VEHICLE WARRANTY

Hyundai Motor India Limited hereinafter called "HMIL", warrants that each new Hyundai vehicle sold shall be free from any defects in material and workmanship, under normal use and maintenance, subject to the following terms and conditions.

### 1. Warranty Period

This warranty for Hyundai vehicle shall exist for a period of 36 months from the date of delivery to the first purchaser irrespective of the mileage. However the warranty for Hyundai vehicle being used for commercial purpose such as Taxi/Tourist operation is 36 months/100,000 Kms from the date of delivery to the first purchaser which soever is earlier. This warranty is transferable to subsequent owner for the remaining warranty period. This warranty is applicable only in India and not transferable to any other country.

### 2. What is covered

Except as provided in paragraph 3 hereof, our Authorized Dealers shall either repair or replace, any Hyundai genuine part that is acknowledged by HMIL to be defective in material or workmanship within the warranty period stipulated above, at no cost to the owner of the Hyundai vehicle for parts or labour. Such defective parts which have been replaced will become the property of HMIL

### 3. What is not covered

*This warranty shall not apply to:*

- ▶ Normal maintenance services other than the three labour free services, including without limitation, cleaning and polishing, minor adjustments, engine tuning, oil/fluid changes, filters replenishment, fastener retightening, wheel balancing, wheel alignment and tyre rotation etc.
- ▶ Replacement of parts as a result of normal wear and tear such as spark plugs, belts, brake pads and linings, clutch disc/facing, filters, wiper blades, bulbs, fuses, etc.

*Damage or failure resulting from :*

- ▶ Negligence of proper maintenance as required in this Owner's Manual and Service Booklet.
- ▶ Misuse, abuse, accident, theft, flooding or fire.
- ▶ Use of improper or insufficient fuel, fluids or lubricants.
- ▶ Use of parts other than Hyundai Genuine Parts.
- ▶ Any device and/or accessories not supplied by HMIL.
- ▶ Modifications, alterations, tampering or improper repair.
- ▶ Parts used in applications of which they were not designed or not approved by HMIL.
- ▶ Slight irregularities not recognised as affecting quality or function of the vehicle or parts, such as slight noise or vibrations, or items considered characteristic of the vehicle.
- ▶ Airborne "fallout", Industrial fallout, acid rain, hail and windstorms, or other Acts of God.

- ▶ Paint scratches, dents or similar-paint or body damage.
- ▶ Action of road elements (sand,- gravel, dust or road debris) which results in stone chipping of paint or glass.
- ▶ Incidental or consequential damages, including without limitation, loss of time, inconvenience, loss of use of vehicle or commercial loss.

Audio Video Navigation System, Air Purifier, Batteries, Tyres & Tubes, Audio Systems, or any external accessory originally equipped on Hyundai vehicles are warranted directly by the respective manufacturers and not by HMIL.

- ▶ This warranty is the entire warranty given by HMIL for Hyundai vehicles and no dealer or its or his agent or employee is authorized to extend or enlarge this warranty and no dealer or its or his agent or employee is authorized to make any oral warranty on HMIL's behalf.
- ▶ HMIL reserves the right to make any change in design or make any improvement on the vehicle at any time without any obligation to make the same change on vehicles previously sold.
- ▶ HMIL reserves the right for the final decision in all warranty matters.

### **Owner's Responsibilities**

- ▶ Proper use, maintenance and care of vehicle in accordance with the instructions contained in this Owner's Manual and Service Booklet. If the vehicle is subject to severe usage conditions, su-

such as operation in extremely dusty, rough, more repeated short distance driving or heavy city traffic during hot weather, maintenance of vehicle should be done more frequently as mentioned in this Owner's Manual and Service Booklet

- ▶ Retention of maintenance service records. It may be necessary for the customer to show that the required maintenance has been performed, as specified in this Owner's Manual and Service Booklet.
- ▶ Delivery of the vehicle during regular service business hours to any authorized Hyundai Dealer to obtain warranty service.
- ▶ In order to maintain the validity of this Basic Warranty, the vehicle must be serviced by Hyundai Authorized workshop in accordance to the Owner's Manual and Service Booklet.

## **PARTS REPLACEMENT WARRANTY**

Hyundai Motor India Limited hereinafter called "HMIL", warrants that each new Hyundai Genuine replacement part purchased from and installed by Hyundai Authorized Dealer shall be free from any defects in material or workmanship, under normal use and maintenance, subject to the following terms and conditions

### **1. Warranty period**

This warranty shall exist for a period of 6 months or until the vehicle has

been driven for a distance of 10,000 Kilometers from the date of installation of replacement part by Hyundai Authorized Dealer, whichever occurs first.

## **2. What is covered**

Our Authorized Dealers shall either repair or replace, any Hyundai genuine part listed in paragraph 3 hereof, that is acknowledged by HMIL to be defective in material or workmanship within the warranty period stipulated above, after examinations carried out to confirm that none of the original settings have been tampered with, at no cost to the owner of the Hyundai vehicle for parts or labour. Such defective parts which have been replaced will become the property of HMIL

## **3. What is not covered**

This warranty shall not apply to:

- Normal maintenance services of parts such as cleaning, adjustment or replacement (i.e. spark plugs that are oil fouled, lead fouled, or which fail due to the use of low grade fuel).
- Parts that fail due to abuse, misuse, neglect, alteration or accident or which have been improperly lubricated or repaired
- Parts used in applications for which they were not designed or approved by HMIL.
- Failure due to normal wear of parts.
- Direct or indirect failures caused by misuse and improper maintenance of vehicle.

- Any vehicle on which the odometer reading has been altered so that mileage cannot be accurately determined.
- Incidental or consequential damages, including without limitation, loss of time, inconvenience, loss of use of vehicle or commercial loss.

This warranty is the entire warranty given by HMIL for Hyundai replacement parts and no dealer or its agent or employee is authorized to extend or enlarge this warranty and no dealer or its agent or employee is authorized to make any oral warranty on HMIL's behalf. HMIL reserves the right for the final decision in all warranty matters.

## **Owner's Responsibility :**

- Proper use, maintenance and care of the vehicle in accordance with the instructions contained in the Owner's Manual and Service Booklet.
- Retention of maintenance service records. It may be necessary for the customer to show that the required maintenance has been performed, as specified in this Owner's Manual and Service Booklet.
- **Retention of the customer's copy of the original repair order and its invoice/bill against which the part was replaced.**
- Delivery of the vehicle during regular service business hours to the same Hyundai Authorized Dealer who had sold and installed the replacement part
- In order to maintain the validity



of this Parts replacement Warranty, the vehicle must be serviced by Hyundai Authorized workshop in accordance to the Owner's Manual and Service Booklet.

#### **HYUNDAI EXTENDED WARRANTY\***

HML offers optional paid extended warranty on selected models, in addition to the basic new vehicle warranty. For more details on Hyundai Extended Warranty please call the nearest dealer or our toll free number 1-800-11-4645.

Or Visit our Hyundai Website

[www.hyundai.co.in](http://www.hyundai.co.in)

*\*Conditions apply*

#### **Labour Free Service of Vehicle**

Your vehicle is entitled for first three labour free services of Periodic Maintenance Schedule (PMS). Please refer page 1-7 for labour free service coupons and page 1-8 for PMS services.

#### **NOTICE :**

All Consumables, Wheel Alignment and / or Part Replacement (if not covered in warranty), if required are chargeable to the customer(s).

We are pleased to introduce you to our 24 X 7 Hyundai Road Side Assistance Programme

## Our Road Side Assistance number is : 1800 102 4645 (toll free)

Hyundai Roadside assistance is a 24 X 7 emergency support provided in the event of any mechanical/electrical breakdown and/or road traffic accident of a vehicle.

Covered Events & Benefits*	
Break Down/Accident	Roadside repair or vehicle recovery in case of breakdown/road traffic accident
Tire Related	Tire Puncture – Replacement of punctured tire with the spare tire
Battery Related	Dead Battery – Jump start
Key Related	Locked keys, lost keys or broken vehicle keys
Fuel Related Support	Out of fuel, incorrect or contaminated fuel
Taxi Support	Assistance provided in form of taxi support to customers

\*Terms and conditions apply

#### Terms and Conditions

- The Service is applicable for 3 years from the date of sale.
- The 24 X 7 Road Side Assistance is available up to a nearest Hyundai Authorized dealer workshop.
- The Service is applicable for a condition in which the vehicle has been immobile.
- Cost of parts/replacement is not included, unless covered under Hyundai Warranty.
  - Cost of repairs made to your vehicle is not included, unless it is covered under Hyundai Warranty.
  - Taxi Support will be provided upto 100 KM's and only in case of accidental & breakdown towing.
  - For Online retail RSA & Complete TNC's, kindly visit: <http://www.hyundaiassistanceindia.in>

**1<sup>st</sup> Labour Free Service  
Coupon**

(1,200-1,500 km or within 2 months of  
delivery, whichever is earlier)

**Customer Copy**

Model Name \_\_\_\_\_  
Customer's Name \_\_\_\_\_  
VIN \_\_\_\_\_  
Registration No. \_\_\_\_\_  
Mileage \_\_\_\_\_  
Delivery Date \_\_\_\_\_  
Service Date \_\_\_\_\_  
RO Number \_\_\_\_\_  
Dealer/HASC code \_\_\_\_\_

**Servicing Dealer's Stamp**

Service Mgr's Signature \_\_\_\_\_

**2<sup>nd</sup> Labour Free Service  
Coupon**

(9,000-10,000 km or within 12 months of  
delivery whichever is earlier)

**Customer Copy**

Model Name \_\_\_\_\_  
Customer's Name \_\_\_\_\_  
VIN \_\_\_\_\_  
Registration No. \_\_\_\_\_  
Mileage \_\_\_\_\_  
Delivery Date \_\_\_\_\_  
Service Date \_\_\_\_\_  
RO Number \_\_\_\_\_  
Dealer/HASC code \_\_\_\_\_

**Servicing Dealer's Stamp**

Service Mgr's Signature \_\_\_\_\_

**3<sup>rd</sup> Labour Free Service  
Coupon**

(19,000-20,000 km or within 24 months of  
delivery whichever is earlier)

**Customer Copy**

Model Name \_\_\_\_\_  
Customer's Name \_\_\_\_\_  
VIN \_\_\_\_\_  
Registration No. \_\_\_\_\_  
Mileage \_\_\_\_\_  
Delivery Date \_\_\_\_\_  
Service Date \_\_\_\_\_  
RO Number \_\_\_\_\_  
Dealer/HASC code \_\_\_\_\_

**Servicing Dealer's Stamp**

Service Mgr's Signature \_\_\_\_\_

**CHECK LIST FOR FREE SERVICE 1,500 KM - 20,000 KM**

A - ADD    I - INSPECT    C - CLEAN    R - REPLACE    L - LUBRICATE    I (IR) - INSPECT IF REQUIRED    TR - TYRE ROTATION  
(AFTER INSPECTION, ADD, REPAIR OR REPLACE IF NECESSARY)

No.	Item Description	1st Service		2nd Service		3rd Service	
		Reqd.	Done	Reqd.	Done	Reqd.	Done
<b>A ENGINE BAY</b>							
1	Engine oil & filter*	I	R	-	-	R	-
2	Engine Timing Chain / belt	-	-	-	-	-	-
3	Air cleaner filter (Petrol only)*	-	C	-	-	C	-
4	Air cleaner filter (T-Gdi only)*	-	C	-	-	R	-
5	Air cleaner Filter (Diesel only)*	-	C	-	-	R	-
6	Battery condition & specific gravity	I	I	-	-	-	-
7	Throttle body (Petrol only)	-	-	-	-	-	-
8	Spark plugs (Petrol only)	-	C	-	-	C	-
9	Valve clearance	I (IR)	I (IR)	-	-	I (IR)	-
10	Hoses (Vacuum/ EGR/ VGT/ WGT)	-	I	-	-	I	-
11	Crankcase ventilation hose	I	I	-	-	I	-
12	Tensioner/idler/damper pulley	I (IR)	I (IR)	-	-	I (IR)	-
13	Power steering fluid and leakages**	-	-	-	-	-	-
14	Brake/Clutch fluid	I	I	-	-	I	-
15	Engine coolant	I	I	-	-	I	-
16	Manual transaxle fluid	-	-	-	-	-	-
17	Automatic/CVT/IVT/DCT/IVT transaxle fluid**	-	-	-	-	-	-
<b>B VEHICLE ON FLOOR</b>							
18	Wiper (wiper blade, washer fluid)	I	I	-	-	I	-
19	Brake/Clutch (free play & leakages)	I	I	-	-	I	-
20	Fuel filler cap	-	-	-	-	-	-
21	Climate control air filter*	-	C	-	-	R	-
22	Check AC system (refrigerant/compressor)	I	I	-	-	I	-
23	Cooling system & leakage	I	I	-	-	I	-
<b>C VEHICLE ON LIFT</b>							
24	4WD Shaft differential Transfer case oil**	-	-	-	-	-	-
25	Steering gear rack, linkage and boots	I	I	-	-	I	-
26	Exhaust system	I	I	-	-	I	-
27	Fuel filter (Petrol only)	-	-	-	-	-	-
28	Fuel filter cartridge (Diesel only)*	-	-	-	-	-	-
29	Charcoal Canister (Petrol only)	-	-	-	-	-	R
30	Fuel tank air filter (if equipped) (Petrol only)**	-	-	-	-	-	-
31	Front & rear suspension (linkages & ball joints)	I	I	-	-	I	-
32	Fuel lines, hoses and connections	I	I	-	-	I	-
33	Driveshafts & boots	I	I	-	-	I	-
34	Fluid leakages	I	I	-	-	I	-
35	Front and rear wheel bearing & bushes	I (IR)	I (IR)	-	-	I (IR)	-
36	Front and rear disc/drum brakes & pads	I	I	-	-	I	-
37	Parking brake (disc, shoe & operation)	I	I	-	-	I	-
38	Wheel alignment & balancing*	-	-	-	-	I (IR)	-
39	Tyre pressure, condition & rotation*	-	-	-	-	I, TR	-
<b>D FINAL CHECKS</b>							
40	Bolt and nuts on chassis and body	I	I	-	-	I	-
41	Lubricate locks & hinges	I	I	-	-	L	-
42	All electrical systems (drive belts, alternator)	I	I	-	-	I	-
43	Warning lights operation & GDS system check	I	I	-	-	I	-
44	Ext & int. lights, horn & gauges	I	I	-	-	I	-
45	Sumoof operation (if equipped)	C	C	-	-	C	-
46	All seat belt operation	I	I	-	-	I	-
47	Road test	I (IR)	I (IR)	-	-	I (IR)	-

\*All consumables are chargeable to the customer(s)

\*\*If Applicable

1st Service - 1,500 km/2 months  
2nd Service - 10,000 km/12 months  
3rd Service - 20,000 km/24 months

# 2. Vehicle Information

- Exterior overview (Front view)..... 2-2
- Exterior overview (Rear view)..... 2-4
- Interior overview..... 2-6
- Centre console overview ..... 2-8
- Steering wheel control overview ..... 2-10
- Engine compartment overview ..... 2-11
- Dimensions ..... 2-14
- Engine..... 2-14
- Bulb wattage..... 2-15
- Tyres and wheels ..... 2-16
- Air conditioning system ..... 2-17
- Vehicle weight and luggage volume ..... 2-17
- Recommended lubricants and capacities ..... 2-18
  - Recommended SAE viscosity number ..... 2-19
- Vehicle identification number (VIN)..... 2-21
- Vehicle certification label ..... 2-21
- Tyre specification and pressure label ..... 2-22
- Engine number ..... 2-22
- Air conditioner compressor label ..... 2-23

## Exterior overview (Front view)

Type A



The actual shape may differ from the illustration.

(1) Bonnet .....	5-33
(2) Front windscreen wiper blades .....	5-49, 9-36
(3) Outside rearview mirror .....	5-22
(4) Front light.....	5-38, 9-68
(5) Sunroof .....	5-29
(6) Windows.....	5-26
(7) Tyres and wheels .....	9-43

Type B (N Line)



The actual shape may differ from the illustration.

(1) Bonnet .....	5-33
(2) Front windscreen wiper blades .....	5-49, 9-36
(3) Outside rearview mirror .....	5-22
(4) Front light .....	5-38, 9-68
(5) Sunroof .....	5-29
(6) Windows .....	5-26
(7) Tyres and wheels .....	9-43

## Exterior overview (Rear view)

Type A



The actual shape may differ from the illustration.

(1) Door .....	5-15
(2) Fuel filler door .....	5-36
(3) Antenna .....	5-82
(4) High mounted stop lamp .....	9-73
(5) Rear windscreen wiper blade .....	5-49
(6) Tailgate .....	5-34
(7) Wide-rear view camera .....	7-74
(8) Rear Ultrasonic sensors.....	7-89
(9) Rear combination light.....	5-38, 9-70



Type B (N Line)



The actual shape may differ from the illustration.

(1) Door .....	5-15
(2) Fuel filler door .....	5-36
(3) Antenna .....	5-82
(4) High mounted stop lamp .....	9-73
(5) Rear windscreen wiper blade .....	5-49
(6) Tailgate.....	5-34
(7) Wide-rear view camera .....	7-74
(8) Rear Ultrasonic sensors.....	7-89
(9) Rear combination light.....	5-38, 9-70

## Interior overview



The actual shape may differ from the illustration.

(1) Inside door handle .....	5-15
(2) Outside rearview mirror control switch .....	5-23
(3) Outside rearview mirror folding switch .....	5-23
(4) Central door lock switch .....	5-16
(5) Power window switches .....	5-27
(6) Power window lock button .....	5-28
(7) Headlight levelling device.....	5-41
(8) ESC (Electronic Stability Control) OFF button.....	6-46
(9) Parking Safety button.....	7-90
(10) ISG (Idle Stop and Go) OFF button.....	6-53
(11) Ignition switch/Engine Start/Stop button .....	6-5, 6-8
(12) Bonnet release lever.....	5-33
(13) Steering wheel .....	5-19
(14) Seat.....	3-4

(15)Fuse box .....	9-52
(16)Fuel filler door open lever .....	5-36

## Centre console overview



The actual shape may differ from the illustration.

(1) Instrument cluster .....	4-2
(2) Horn .....	5-20
(3) Driver's front airbag .....	3-35
(4) Engine Start/Stop button .....	6-8
(5) Infotainment system .....	5-83
(6) Hazard warning flasher switch .....	8-2
(7) Manual climate control system/Automatic climate control system .....	5-52/5-59
(8) Passenger's front air bag .....	3-35
(9) Glove box .....	5-72
(10) Automatic transmission/Manual transmission/Intelligent variable transmission/Dual clutch transmission .....	6-15/6-20/6-22/6-29
(11) USB Port .....	5-81
(12) Power outlet .....	5-75
(13) USB charger .....	5-76

(14)Wireless smartphone charging system.....	5-77
(15)Drive/Traction mode control button.....	6-55
(16)EPB (Electronic Parking Brake) switch.....	6-40
(17)Auto Hold button.....	6-43
(18)Air ventilation seat.....	3-15
(19)Parking/View button.....	7-72
(20)Center console storage.....	5-72
(21)Second row USB charger.....	5-76

## Steering wheel control overview



The actual shape may differ from the illustration.

(1) Wiper and washer control lever.....	5-49
(2) Lighting control lever .....	5-38
(3) Paddle shifter .....	6-18
(4) Voice recognition button .....	5-83
(5) Audio remote control buttons .....	5-82
(6) Bluetooth® hands-free phone button .....	5-84
(7) Cluster display controls.....	4-29
(8) Driving Assist button .....	7-49
(9) Lane Driving Assist button .....	7-68
(10) Vehicle Distance button.....	7-56

## Engine compartment overview

Smartstream G15 MPI

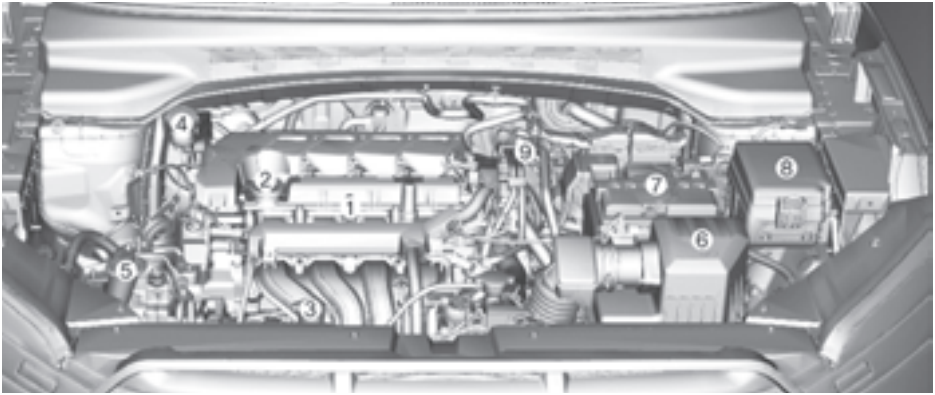

The actual engine compartment in the vehicle may differ from the illustration.

(1) Engine oil dipstick .....	9-25
(2) Engine oil filler cap .....	9-25
(3) Cooling system parts .....	9-29
(4) Brake/clutch fluid reservoir .....	9-31
(5) Windscreen washer fluid reservoir .....	9-32
(6) Air cleaner .....	9-34
(7) Battery .....	9-40
(8) Fuse box .....	9-52

Smartstream G1.5 T-GDi

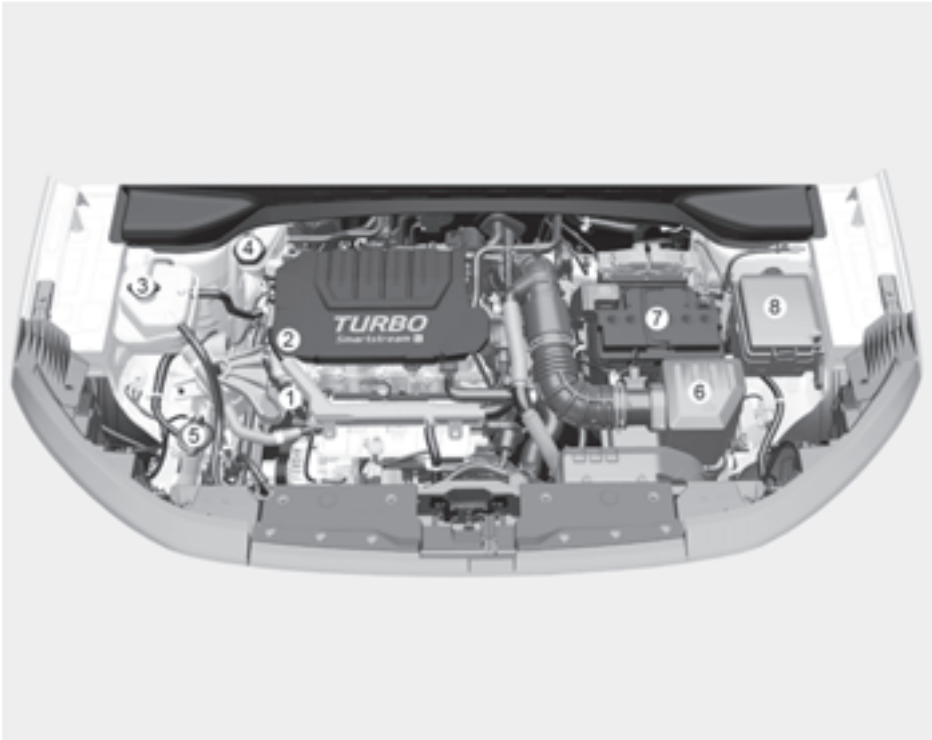

The actual engine compartment in the vehicle may differ from the illustration.

(1) Engine oil dipstick .....	9-25
(2) Engine oil filler cap .....	9-25
(3) Engine coolant reservoir .....	9-29
(4) Brake/clutch fluid reservoir .....	9-31
(5) Windscreen washer fluid reservoir .....	9-32
(6) Air cleaner .....	9-34
(7) Battery .....	9-40
(8) Fuse box .....	9-52



## Diesel 15 VGT

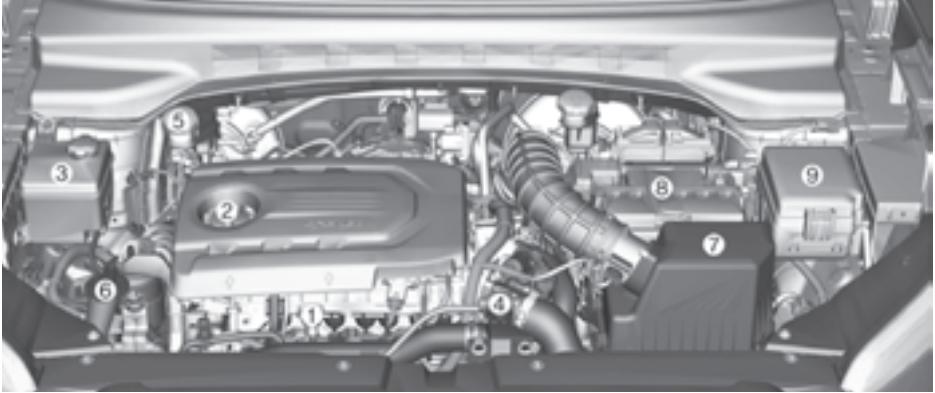

The actual engine compartment in the vehicle may differ from the illustration.

(1) Engine oil dipstick .....	9-25
(2) Engine oil filler cap .....	9-25
(3) Engine coolant reservoir .....	9-29
(4) Radiator cap.....	9-29
(5) Brake/clutch fluid reservoir .....	9-31
(6) Windscreen washer fluid reservoir .....	9-32
(7) Air cleaner .....	9-34
(8) Battery .....	9-40
(9) Fuse box .....	9-52

## Dimensions

Items		mm (inch)
Overall length		4,330 (170.47)
Overall width		1,790 (70.47)
Overall height	Without roof rack	1,620 (63.78)
	With roof rack	1,635 (64.37)
Front tread	205/65 R16	1,572 (61.89)
	215/60 R17	1,560 (61.42)
Rear tread	205/65 R16	1,576 (62.05)
	215/60 R17	1,564 (61.57)
Wheelbase		2,610 (102.75)

## Engine

Engine		Displacement cc (cu. in)	Bore x Stroke mm (inch)	Firing order	No. of cylinders
Petrol Engine	Smartstream G15 MPI	1,497 (91.35)	75.6 x 83.4 (2.98 x 3.28)	1-3-4-2	4
	Smartstream G15 T-GDi	1,482 (90.44)	71.6 x 92 (2.89 x 3.62)	1-3-4-2	4
Diesel Engine	Diesel 15 VGT	1,493 (91.11)	75.0 x 84.5 (2.95 x 3.33)	1-3-4-2	4

## Bulb wattage

Light bulb				Bulb type	Wattage
Front	Headlight	Type A	High	H18	65W
			Low	H7	55W
	Daytime running light/Position light	Type B	High/Low	LED	LED
					LED
	Turn signal light	Type A		PY21W	21W
		Type B		LED	LED
Rear	Stop light	Type A		P21W	21W
		Type B		LED	LED
	Tail light			LED	LED
	Turn signal light	Type A		PY21W	21W
		Type B		LED	LED
	Backup light			W16W	16W
	High mounted stop light			LED	LED
	License plate light			W5W	5W
Interior	Map lamp	Type A		WEDGE	8W
		Type B		LED	LED
	Personal lamp (if equipped)			LED	LED
	Room lamp (if equipped)			FESTOON	10W
	Luggage compartment lamp			FESTOON	10W
	Mood lamp (if equipped)			LED	LED

## Tyres and wheels

Items	Tyre size	Wheel size	Inflation pressure kPa (psi)				Wheel nut torque kgf·m (lbf·ft, N·m)
			Normal load <sup>*1</sup>		Maximum load		
			Front	Rear	Front	Rear	
Full size tyre	205/65R16	6.0J X 16	230 (33)		240 (35)		11-13 (79-94, 107-127)
	215/60R17	6.5J X 17					
Spare tyre	205/65R16	6.0J X 16	230 (33)		240 (35)		
	215/60R17	6.5J X 17					

\*1Up to 3 persons

### NOTICE

- It is permissible to add 20 kPa (3 psi) to the standard tyre pressure specification if colder temperatures are expected soon.  
Tyres typically lose 7 kPa (1psi) for every 7 °C (12 °F) temperature drop. If extreme temperature variations are expected, recheck your tyre pressure as necessary to keep them properly inflated.
- Tyre inflation pressures may differ depending on changes in elevation (about 10 kPa (2.4 psi) for every kilometer (or mile) elevation change). If driving in areas of higher or lower elevation, be sure to check and adjust for proper tyre inflation.
- Do not exceed the maximum inflation pressure, as found on the sidewall of the tyre(s).
- Spare wheel are intended for emergency purpose.
- Only steel wheel is provided as spare wheel. Spare tires can be from any manufacturer.

### CAUTION

When replacing tyres, ALWAYS use the same size, type, brand, construction, and tread pattern supplied with the vehicle. If not, it can damage the related parts or make it work irregularly.

## Air conditioning system

Item	Weight of volume g (oz.)	Classification
Refrigerant	525±25 (18.5±0.88)	R-134a
Compressor lubricant	110±10 (3.88±0.35)	FD46XG (IDEMITSU)

We recommend that you to contact a HYUNDAI authorised repairer for more details.

## Vehicle weight and luggage volume

Items	Smartstream G1.5 MPI		Smartstream G1.5 T-GDi		Diesel 1.5 VGT	
	M/T <sup>*1</sup>	IVT <sup>*2</sup>	M/T <sup>*1</sup>	DCT <sup>*3</sup>	M/T <sup>*1</sup>	A/T <sup>*4</sup>
Gross vehicle weight [kg (lbs.)]	1,700 (3,748)	1,730 (3,814)	1,765 (3,891)	1,795 (3,957)	1,805 (3,979)	1,835 (4,045)
Luggage volume [ℓ (cu. ft)]	MAX: 1,401(49.47) MIN: 433 (15.29)					

\*1 M/T: Manual Transmission

\*2 IVT: Intelligent Variable Transmission

\*3 DCT: Dual Clutch Transmission

\*4 A/T: Automatic Transmission

## Recommended lubricants and capacities

To help achieve proper engine and powertrain performance and durability, use only lubricants of the proper quality. The correct lubricants also help promote engine efficiency that results in improved fuel economy.

Lubricant		Volume	Classification	
Engine oil *1*2 (drain and refill) Recommends	Smartstream G15 MPI		SAE 0W-20, API SN PLUS/SP or ILSAC GF-6 <sup>5</sup>	
	Smartstream G15 T-GDi			
	Diesel 15 VGT	With DPF <sup>3</sup>	4.8 ℓ (5.07 US qt.)	ACEA C5 or C3 or C2
		Without DPF <sup>3</sup>		ACEA C5 or C3 or C2 or A3/B4 <sup>6</sup>
Manual transmission fluid	Smartstream G15 MPI		API Serviced GL-4, SAE 70W, TGO-9 (HYUNDAI genuine transmission fluid)	
	Diesel 15 VGT			
Intelligent variable transmission fluid	Smartstream G15 MPI		IVTF SP-CVT1 <sup>7</sup>	
Auto transmission fluid	Diesel 15 VGT		SK ATF SP4M-1, Hyundai Genuine ATF SP4M-1	
Dual clutch transmission fluid	Smartstream G15 T-GDi		API GL4, SAE 70W (HYUNDAI genuine transmission fluid)	
Coolant	Smartstream G15 MPI	M/T	Mixture of antifreeze and distilled water (Ethylene glycol base coolant for aluminum radiator)	
		IVT		
	Smartstream G15 T-GDi	M/T		
		DCT		
	Diesel 15 VGT	M/T		
		A/T		

Lubricant	Volume	Classification
Brake/clutch fluid (if equipped)*4	0.7-0.8 ℓ (0.74-0.85 US qt.)	SAE J1704 DOT-4LV, FMVSS 116 DOT-4, ISO4925 CLASS-6
Fuel	50 ℓ*8 (13.21 US gal.)	
Urea (if equipped)	12 ℓ (12.68 US qt.)	ISO22241, DIN70070

\*1 Refer to the “Recommended SAE viscosity number” in this section.

\*2 Engine oils labelled Energy Conserving Oil are now available. Along with other additional benefits, they contribute to fuel economy by reducing the amount of fuel necessary to overcome engine friction. Often, these improvements are difficult to measure in everyday driving, but in a year’s time, they can offer significant cost and energy savings.

\*3 DPF: Diesel Particulate Filter

\*4 To maintain the best braking performance and ABS/ESC performance, we recommend that you use genuine brake fluid that conform to specifications.

\*5 Requires <API SN PLUS (or above) Full synthetic> grade engine oil. If a lower grade engine oil (mineral oil including semi-synthetic) is used, then the engine oil and engine oil filter must be replaced as indicated severe maintenance condition.

\*6 If the recommended engine oil is not available in your country, you are able to use engine oil above API CH-4 or above.

\*7 Use only specified genuine Intelligent Variable Transmission fluid. The use of non-specified fluid (even marked as compatible with genuine) could result in shift quality deterioration and vibrations, eventually, the transmission failure.

\*8 The fuel filling capacity mentioned is less than the actual fuel tank capacity. The extra capacity in tank is provided to cater the vapour creation of fuel and prevent leakage of volatile organic compounds and fuel into the atmosphere. Further, it is recommended that do not fill the tank after auto cut-off at the fuel station during filling fuel..

## Recommended SAE viscosity number

### NOTICE

Always be sure to clean the area around any filler plug, drain plug, or dipstick before checking or draining any lubricant. This is especially important in dusty or sandy areas and when the vehicle is used on unpaved roads. Cleaning the plug and dipstick areas will prevent dirt and grit from entering the engine and other mechanisms that could be damaged.

Engine oil viscosity (thickness) has an effect on fuel economy and cold weather operating (engine start and engine oil flow ability). Lower viscosity engine oils can provide better fuel economy and cold weather performance, however, higher viscosity engine oils are required for satisfactory lubrication in hot weather. Using oils of any viscosity other than those recommended could result in engine damage.

Never add any additives to the engine oil. Engine oil additives can change the properties of engine oil and may cause serious engine failure.

When choosing an oil, consider the range of temperature your vehicle will be operated in before the next oil change. Proceed to select the recommended oil viscosity from the chart.

Temperature Range for SAE Viscosity Numbers											
Temperature	°C	-30	-20	-10	0	10	20	30	40	50	
	(°F)		-10	0	20	40	60	80	100	120	
Smartstream G15 MPI / Smartstream G15 T-GDi*1	0W-20										
Diesel 1.5 VGT	10W-30/40										
	5W-30/40										
	0W-30										
	0W-20										

\*1 Requires <API SN PLUS (or above) Full synthetic> grade engine oil. If a lower grade engine oil (mineral oil including Semi-synthetic) is used, then the engine oil and engine filter must be replaced as indicated severe maintenance condition.



An engine oil displaying this American Petroleum Institute (API) Certification Mark conforms to the International Lubricant Specification Advisory Committee (ILSAC). It is recommended to only use engine oils that uphold this API Certification Mark.



## Vehicle identification number (VIN)

**+** if equipped

Frame number (if equipped)



The vehicle identification number (VIN) is the number used in registering your vehicle and in all legal matters pertaining to its ownership, etc.

The number is punched on the floor under the right front seat. To check the number, open the cover.

## Vehicle certification label

**+** if equipped



The vehicle certification label attached on the driver's (or front passenger's) side centre pillar gives the vehicle identification number (VIN).

## Tyre specification and pressure label



The tyres supplied on your new vehicle are chosen to provide the best performance for normal driving. The tyre label located on the driver's side centre pillar gives the tyre pressures recommended for your vehicle.

## Engine number

Smartstream G15 MPI

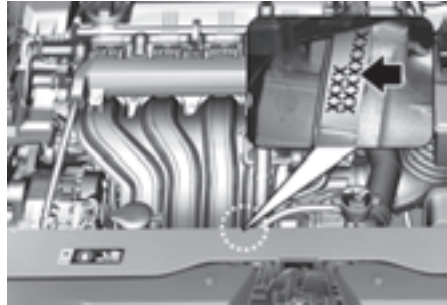

Smartstream G15 T-GDI

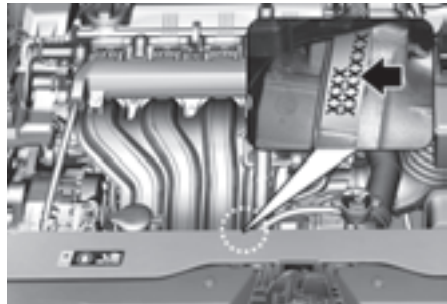

Diesel 1.5 VGT



The engine number is stamped on the engine block as shown in the drawing.

## Air conditioner compressor label

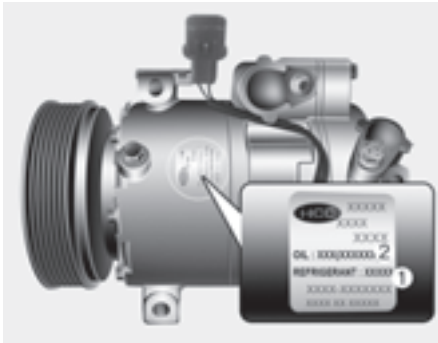

A compressor label informs you the type of compressor your vehicle is equipped with such as model, supplier part number, production number, refrigerant (1) and refrigerant oil (2).



# 3. Seats & Safety System

- Important safety precautions ..... 3-2
  - Always wear your seat belt..... 3-2
  - Restrain all children ..... 3-2
  - Airbag hazards..... 3-2
  - Driver distraction ..... 3-2
  - Never drink or take drugs and drive ..... 3-3
  - Control your speed ..... 3-3
  - Keep your vehicle in safe condition..... 3-3
- Seats ..... 3-4
  - Safety precautions ..... 3-5
  - Front seats ..... 3-6
  - Rear seats ..... 3-9
  - Head restraint..... 3-11
- Air ventilation seats ..... 3-15
- Seat belts ..... 3-16
  - Seat belt safety precautions ..... 3-16
  - Seat belt warning light..... 3-17
  - Seat belt restraint system..... 3-18
  - Additional seat belt safety precautions..... 3-22
  - Care of seat belts ..... 3-25
- Child Restraint System (CRS) ..... 3-25
  - Our recommendation: Children always in the rear ..... 3-25
  - Selecting a Child Restraint System (CRS) ..... 3-26
  - Installing a Child Restraint System ..... 3-28
- Airbag - supplemental restraint system..... 3-34
  - SRS Components ..... 3-36
  - Where are the airbags? ..... 3-36
  - How does the airbags system operate? ..... 3-39
  - What to expect after an airbag inflates ..... 3-42
  - Do not install a Child Restraint System on the front passenger's seat ..... 3-42
  - SRS warning light..... 3-43
  - Why didn't my airbag go off in a collision? ..... 3-43
  - SRS care..... 3-47
  - Additional safety precautions ..... 3-48
  - Airbag warning label ..... 3-49

## Important safety precautions

You will find many safety precautions and recommendations throughout this section, and throughout this manual. The safety precautions in this section are among the most important.

### Always wear your seat belt

A seat belt is your best protection in all types of accidents. Airbags are designed to supplement seat belts, not to replace them. So even though your vehicle is equipped with airbags, always make sure you and your passengers wear your seat belts, and wear them properly.

### Restrain all children

All children under age 13 should ride in your vehicle properly restrained in a rear seat, not the front seat. Infants and small children should be restrained in an appropriate Child Restraint System. Larger children should use a booster seat with the lap/shoulder belt until they can use the seat belt properly without a booster seat.

### Airbag hazards

Whilst airbags can save lives, they can also cause serious or fatal injuries to occupants who sit too close to them, or who are not properly restrained. Infants, young children, and short adults are at the greatest risk of being injured by an inflating airbag. Follow all instructions and warnings in this manual.

## Driver distraction

Driver distraction presents a serious and potentially deadly danger, especially for inexperienced drivers. Safety should be the primary concern when behind the wheel and drivers need to be aware of the wide array of potential distractions, such as drowsiness, reaching for objects, eating, personal grooming, other passengers, and using mobile phones.

Drivers can become distracted when they take their eyes and attention off the road or their hands off the wheel to focus on activities other than driving. To reduce your risk of distraction and an accident:

- Set up your mobile devices (I.e. MP3 players, phones, navigation units, etc.) ONLY when your vehicle is parked or safely stopped.
- ONLY use your mobile device when allowed by laws and conditions permit safe use. NEVER text or email whilst driving. Most countries have laws prohibiting drivers from texting. Some countries and cities also prohibit drivers from using handheld phones.
- NEVER let the use of a mobile device distract you from driving. You have a responsibility to your passengers and others on the road to always drive safely, with your hands on the wheel as well as your eyes and attention on the road.

## Never drink or take drugs and drive

Drinking alcohol or taking drugs can reduce your ability to respond to changing conditions and emergencies. Do not drink or take drugs and drive, and do not let your friends drink or take drugs and drive.

## Control your speed

Excessive speed is a major factor in crash injuries and deaths. Generally, the higher the speed, the greater the risk, but serious injuries can also occur at lower speeds. Never drive faster than is safe for current conditions, regardless of the maximum speed posted.

## Keep your vehicle in safe condition

Having a tyre blowout or a mechanical failure can be extremely hazardous. To reduce the possibility of such problems, check your tyre pressures and condition frequently, and perform all regularly scheduled maintenance.

## Seats

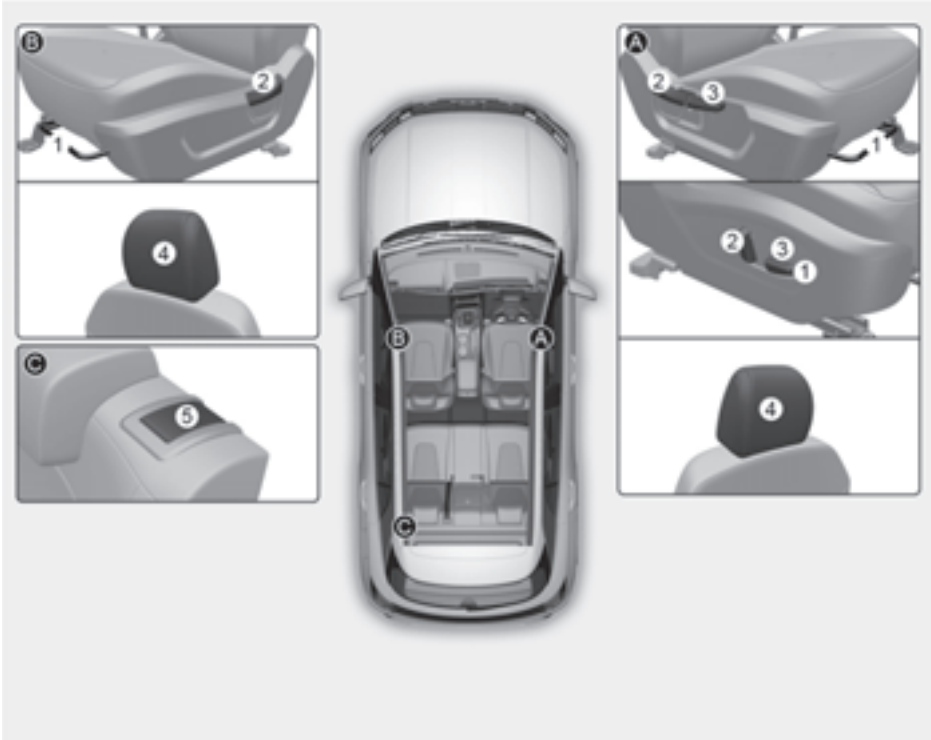

- (1) Forward or rearward
- (2) Seatback angle
- (3) Seat height/Seat cushion angle
- (4) Head restraint
- (5) Seatback folding lever



## Safety precautions

Adjusting the seats so that you are sitting in a safe and comfortable position plays an important role for the safety of the driver and passengers, as much as seat belts and airbags when in an accident.

### WARNING

Do not use a cushion that reduces friction between the seat and the passenger. The passenger's hips may slide under the lap portion of the seat belt during an accident or a sudden stop.

Serious or fatal internal injuries could result because the seat belt cannot operate properly.

---

## Airbags

You can take steps to reduce the risk of being injured by an inflating airbag. Sitting too close to an airbag greatly increases the risk of injury in the event the airbag inflates. Move your seat as far back as possible from front airbags, whilst still maintaining control of the vehicle.

### WARNING

To reduce the risk of serious injury or death from an inflating airbag:

- Adjust the driver's seat as far to the rear as possible whilst maintaining your ability to control the vehicle.
  - Adjust the front passenger seat as far to the rear as possible.
  - Hold the steering wheel by the rim with your hands at the 9 o'clock and 3 o'clock positions to minimise the risk of injuries to your hands and arms.
  - Never place anything or anyone between you and the airbag.
  - Do not allow the front passenger to place feet or legs on the dashboard to minimise the risk of leg injuries.
- 

## Seat belts

Always fasten your seat belt before starting any trip. At all times, passengers should sit upright and be properly restrained with a seat belt. Infants and small children must be restrained in appropriate Child Restraint Systems. Children who have outgrown a booster seat and adults must be restrained using the seat belts.

### WARNING

To prevent serious injury or death:

- Never use one seat belt for more than one occupant.
  - Always position the seatback upright with the lap portion of the seat belt snug and low across the hips.
  - Never allow children or small infants to ride on a passenger's lap.
  - Do not route the seat belt across your neck, across sharp edges, or reroute the shoulder strap away from your body.
  - Do not allow the seat belt to become caught or jammed.
-

## Front seats

### WARNING

To prevent serious injury or death:

- Never attempt to adjust the seat whilst the vehicle is moving. The seat could respond with unexpected movement and may cause loss of vehicle control resulting in a collision.
  - Do not place anything under the front seats. Loose including unsecured floor mats, in the driver's foot area could interfere with the operation of the foot pedals.
  - Do not allow anything to interfere with the normal position and proper locking of the seatback.
  - Do not place a cigarette lighter on the floor or seat.
  - Use extreme caution when picking up small objects trapped under the seats or between the seat and the centre console. Your hands might be cut or injured by the sharp edges of the seat mechanism.
  - If there are occupants in the rear seats, be careful whilst adjusting the front seat.
  - Make sure that the seat is locked in place after the adjustment. If not, the seat might move unexpectedly.
- 

## ***Reclining seatback***

Sitting in a reclined position when the vehicle is moving can be dangerous. Even when buckled up, the protections of your restraint system (seat belts and/or airbags) is greatly reduced by reclining your seatback.

Seat belts must be snug against your hips and chest to work properly.

The more the seatback is reclined, the greater the chance for the passenger's hips to slide under the lap belt or the passenger's neck to strike the shoulder belt.

### WARNING

Never ride with a reclined seatback when the vehicle is moving.

Riding with a reclined seatback increases your chance of serious or fatal injuries in the event of a collision or sudden stop.

Driver and passengers should always sit well back in their seats, properly belted, and with the seatbacks upright.

Seat belts must be snug against your hips and chest to work properly. When the seatback is reclined, the shoulder belt cannot do its job because it will not be snug against your chest. Instead, it will be in front of you. During a collision, you could be thrown into the seat belt, causing neck or other injuries.

The more the seatback is reclined, the greater chance the passenger's hips will slide under the lap belt or the passenger's neck will strike the shoulder belt.

---

## Manual seat adjustment

The front seat can be adjusted by using the levers located underneath the front part of the seat or on the outer side of the seat.

### Forward and rearward adjustment

Type A

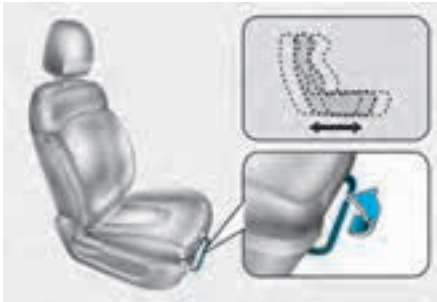

Type B

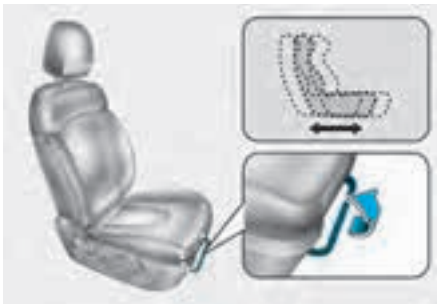

To move the seat forward or rearward:

1. Pull up the seat slide adjustment lever and hold it.
2. Slide the seat to the position desired position.
3. Release the lever and make sure the seat is locked in place. Move forward and rearward without using the lever. If the seat moves, it is not locked properly.

### Seatback angle

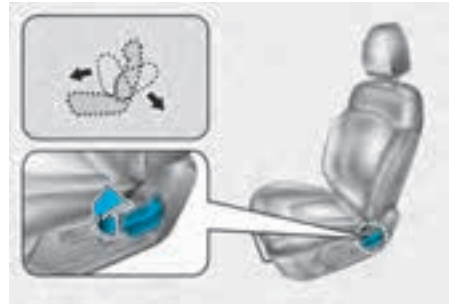

To recline the seatback:

1. Lean forward slightly and lift up the seatback lever.
2. Carefully lean back on the seat and adjust the seatback to the desired position.
3. Release the lever and make sure the seatback is locked in place.

### Seat height (for driver's seat)

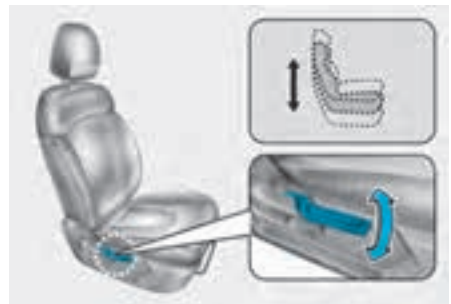

To change the height of the seat cushion:

- Push down on the lever several times, to lower the seat cushion.
- Pull up on the lever several times, to raise the seat cushion.

### Power seat adjustment (for driver's seat)

 If equipped

The front seat can be adjusted by using the control switches located on the outside of the seat cushion.

#### **WARNING**

NEVER allow children to remain in the vehicle unattended. The power seats are operable when the vehicle is turned off.

#### **NOTICE**

To prevent damage to the seats:

- Always stop adjusting the seats when the seat has been adjusted as far forward or rearward as possible.
- Do not adjust the seats longer than necessary when the vehicle is turned off. This may result in unnecessary battery drain.
- Do not operate two or more seats at the same time. This may result in an electrical malfunction.

### Forward and rearward adjustment



To move the seat forward or rearward:

1. Push the control switch forward or rearward.
2. Release the switch once the seat reaches the desired position.

### Seatback angle adjustment



To recline the seatback:

1. Push the control switch forward or rearward.
2. Release the switch once the seatback reaches the desired position.

### Seat cushion and tilt adjustment



To change the angle of the front part of the seat cushion:

1. Push the front portion of the control switch up to raise or down to lower the front part of the seat cushion.
2. Release the switch once the seat reaches the desired position.

To change the height of the seat:

1. Push the rear portion of the control switch up to raise or down to lower the height of the seat.
2. Release the switch once the seat reaches the desired position.

### Seatback pocket



The seatback pocket is provided on the back of the front seatbacks.

#### CAUTION

Do not put heavy or sharp objects in the seatback pockets. In a collision, they can come loose from the pocket and injure occupants.

---

### Rear seats

#### **Folding the rear seats**

The rear seatbacks can be folded to facilitate carrying long items or to increase the rear cargo volume in the vehicle.

Before folding the rear seats, lower the head restraint to the lowest position and store the seat belt to both sides of the seats.

#### WARNING

- Never allow passengers to sit on top of the folded down seatback whilst the vehicle is moving. This is not a proper seating position and no seat belts are available for use. This could result in serious injury or death in a collision or sudden stop.
  - Objects carried on the folded down seatback should not extend higher than the top of the front seatbacks. This can allow cargo to slide forward and cause property damage or serious injury or even death during a collision or sudden stop.
-

### To fold down the rear seatback:

1. Adjust the front seatback to the upright position and if necessary, slide the front seat forward.
2. Lower the rear head restraints to the lowest position by pushing and holding the release button (1) and pushing down on the head restraint (2).

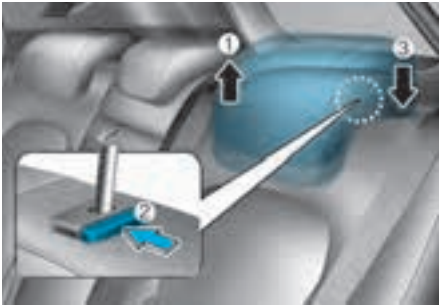

3. Route the seat belt webbing to the outward of the rear seat to prevent the belts from being damaged.



4. Pull up the seatback folding lever, then fold the seat toward the front of the vehicle.

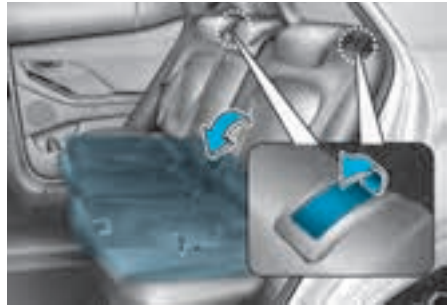

### To unfold the rear seatback:

1. Lift and push the seatback rearward whilst lifting up the front portion of the folding lever.



2. Push the seatback firmly until it clicks into place. Make sure the seatback is locked in place.
3. Return the rear seat belt to the proper position.

### **WARNING**

Lock the seatback properly. In a collision or sudden stop, an unlocked seatback may allow cargo to move forward with great force and may result in serious injury or death.

**⚠ WARNING**

Cargo should always be secured to prevent it from moving in a collision and causing serious injury or death to the vehicle occupants. Do not place objects in the rear seats, because they cannot be properly secured and may hit the front seat occupants in a collision.

**Armrest**

The armrest is located in the centre of the rear seat. Pull the armrest down from the seatback to use it.

**Head restraint**

The vehicle's front and rear seats have adjustable head restraints. The head restraints provide comfort for passengers, but more importantly they are designed to help protect passengers from whiplash and other neck and spinal injuries during an accident, especially in a rear impact collision. When there are no occupants in the rear seats, adjust the rear head restraints to the lowest height to improve the driver's visibility.

**⚠ WARNING**

To reduce the risk of serious injury or death in an accident, take the following precautions when adjusting your head restraints:

- Always adjust the head restraints properly for all passengers **BEFORE** starting the vehicle.
- Never let anyone ride in a seat with the head restraint removed or reversed.
- Adjust the head restraints so that the middle of the head restraint is at the same height as the top of the eyes.



- Never adjust the head restraint position of the driver's seat when the vehicle is moving.
- Adjust the head restraint as close to the passenger's head as possible. Do not use a seat cushion that holds the body away from the seatback.
- Make sure the head restraint locks into position after adjusting it.

**! WARNING**

When passengers are sitting on the rear seats, always raise the head restraints above the lowest stored position.



**Front seat head restraints**

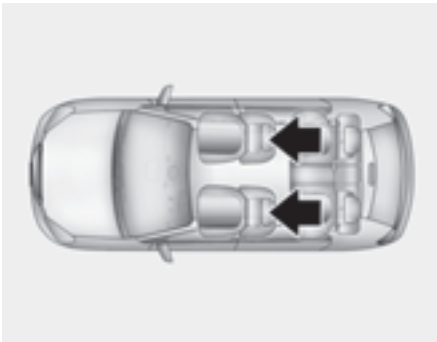

The driver's and front passenger's seats are equipped with adjustable head restraints for the passengers safety and comfort.

**Adjusting the height up and down**

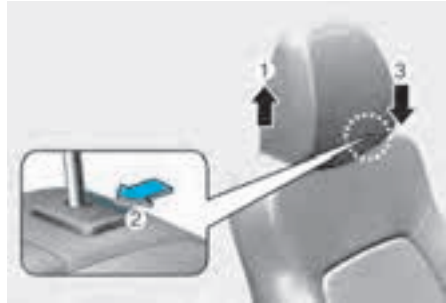

To raise the head restraint:

1. Pull it up to the desired position (1).

To lower the head restraint:

1. Press and hold the release button (2) on the head restraint support.
2. Lower the head restraint to the desired position (3).

**NOTICE**



If you recline the seatback towards the front with the head restraint and seat cushion raised, the head restraint may come in contact with the sunvisor or other parts of the vehicle.



## Removal/Reinstall

To remove the head restraint:

Manual adjustment seat

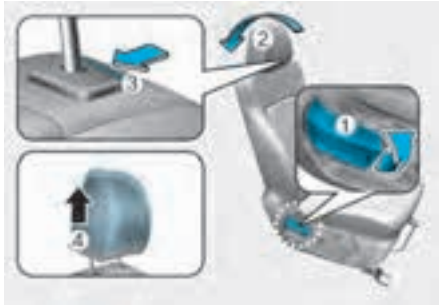

1. Recline the seatback (2) with the seatback angle lever or switch (1).
2. Pull up the head restraint to the upmost position and press the release button (3) to remove the head restraint (4).

### **WARNING**

Never allow anyone to travel in a seat with the head restraint removed.

To reinstall the head restraint:

Manual adjustment seat

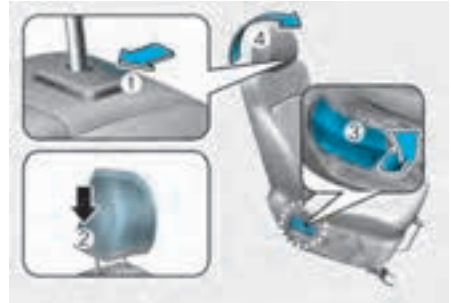

1. Recline the seat back by pressing seatback angle lever or switch (3).
2. Put the head restraint poles (2) into the holes whilst pressing the release button (1).
3. Adjust the head restraint to the appropriate height.
4. Adjust the seatback angle (4) with the seatback angle lever or switch (3).

### **WARNING**

Always make sure the head restraint locks into position after reinstalling and adjusting it properly.

### Rear seat head restraints

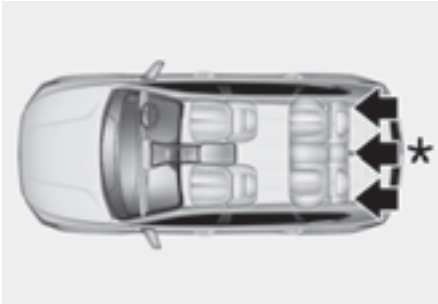

The rear seats are equipped with head restraints in the outboard the seating positions for the passenger's safety and comfort.

### Adjusting the height up and down



To raise the head restraint:

1. Pull it up to the desired position (1).

To lower the head restraint:

1. Press and hold the release button (2) on the head restraint support.
2. Lower the head restraint to the desired position (3).

### Removal/Reinstallation

To remove the head restraint:



1. Raise the head restraint as far as it can go.
2. Press the head restraint release button (1) whilst pulling up the head restraint (3).

To reinstall the head restraint:

1. Put the head restraint poles into the holes (2) whilst pressing the release button (1).
2. Adjust the head restraint to the appropriate height.

## Air ventilation seats

**+** if equipped

The air ventilation seats cool the front seats by blowing air through small vent holes on the surface of the seat cushions and seatbacks.

When the air ventilation seat is not keep the air ventilation seats off.

### NOTICE

To prevent damage to the air ventilation seats:

- Never use a solvent such as paint thinner, benzene, alcohol, or petrol to clean the seats.
- Avoid spilling liquids on the surface of the front seats and seatbacks. This may cause the air vent holes to become blocked and not to work properly.
- Do not place materials such as plastic bags or newspapers under the seats. They may block the air intake causing the air vents not to work properly.
- Do not change the seat covers.
- If the air vents do not operate, restart the vehicle. If there is no change, we recommend that your vehicle be inspected by a HYUNDAI authorised repairer.

## Front air ventilation seats

Type A



Type B



Whilst the engine running, push the switches to cool the driver's seat or front passenger's seat.

- The airflow speed changes, as the following, whenever the switch is toggled.  
High ↔ Medium ↔ Low ↔ Off
- The air ventilation seat defaults to the OFF position whenever the ignition switch is placed to the ON position.
- When pressing the switch for more than 15 seconds with the air ventilation seat operating, the blower operation and switch indication will turn off.

## Seat belts

This section describes how to use the seat belts properly. It also describes some of the things not to do when using seat belts.

### Seat belt safety precautions

Always fasten your seat belt and make sure all passengers have fastened their seat belts before starting any trip. Airbags are designed to supplement the seat belt as an additional safety device, not a replacement. Most countries require all vehicle occupants to wear seat belts.

#### WARNING

Seat belts must be used by ALL passengers whenever the vehicle is moving. To prevent serious injury or death:

- Children under the age of 13 should be properly restrained in the rear seats.
- Never allow children to ride in the front passenger seat, unless the airbag is deactivated. If a child is seated in the front passenger seat, move the seat as far back as possible. And the child must always be restrained in the seat properly.
- NEVER allow an infant or child to be carried on an occupant's lap.
- NEVER ride with the seatback reclined when the vehicle is moving.
- Do not allow children to share a seat or seat belt.
- Do not wear the shoulder belt under your arm or behind your back.
- Do not use the seat belt if it is twisted. A twisted seat belt will not protect you properly in a collision.
- Do not use a seat belt if the webbing or hardware is damaged.
- Do not latch the seat belt into the buckles intended for other seating positions.

- Never unfasten the seat belt whilst driving. This may cause loss of vehicle control resulting in a collision.
  - Make sure there is nothing in the buckle that could interfere with the seat belt latch mechanism from fastening securely.
  - Never modify seatbelt or install devices that may prevent seatbelt assembly from removing slack.
  - Do not use a seat belt if the webbing or hardware is damaged. We recommend that the seat belt be replaced by a HYUNDAI authorised repairer.
- 

#### WARNING

Damaged seat belts and seat belt assemblies do not operate properly. Always replace:

- Frayed, contaminated, or damaged webbing.
  - Damaged hardware.
  - The entire seat belt assembly after it has been worn in an accident, even if damage to webbing or assembly is not apparent.
-

## Seat belt warning light

### Driver's seat belt warning

Instrument cluster



As a reminder to the driver, the driver's seat belt warning lights illuminates for about 6 seconds each time the Engine Start/Stop button is in the ON position regardless of seatbelt fastening.

If continue not to fasten the seat belt or unfasten the seat belt whilst driving under 20 km/h (12 mph), the seat belt warning light illuminates.

If you continue not to fasten the seat belt or unfasten the seat belt whilst driving 20 km/h (12 mph) or faster, the seat belt warning chime sounds for certain period of time and the warning light blinks.

### Front passenger's seat belt warning

Instrument cluster



As a reminder to the front passenger, the front passenger's seat belt warning lights illuminates for about 6 seconds each time the Engine Start/Stop button is turned on regardless of seatbelt fastening.

If the passenger continues to not fasten their seat belt or unfasten their seat belt and you drive under 20 km/h (12 mph), the seat belt warning light illuminates.

If the passenger continues to not fasten their seat belt or unfasten their seat belt and you drive 20 km/h (12 mph) or faster, the seat belt warning chime sounds for certain period of time and the corresponding warning light blinks.

#### WARNING

Riding in an improper position may adversely affect the front passenger's seat belt warning system. Instruct the passenger to properly be seated when the vehicle is moving.

#### *i* Information

- If the front passenger seat is not occupied, the seat belt warning light blinks or illuminate for 6 seconds.
- The front passenger's seat belt warning may operate when luggage is placed on the front passenger seat.

### Rear passenger's seat belt warning

Instrument cluster



- As a reminder to the rear passenger, the rear passenger's seat belt warning lights illuminates for about 6 seconds each time the Engine Start/Stop button is in the ON position regardless of seat belt fastening.
- If the seat belt is not fastened when the Engine Start/Stop button is in the ON position, the seat belt warning light will illuminate for about 70 seconds.
- If the passenger continues to not fasten their seat belt or unfasten their seat belt and you drive under 20 km/h (12 mph), the corresponding warning light continues to illuminate for about 70 seconds.
- If the passenger continues to not fasten their seat belt or unfasten their seat belt and you drive over 20 km/h (12 mph), the seat belt warning chime sounds for about 35 seconds and the corresponding warning light blinks.
- If the rear door is opened or closed under 10 km/h (6 mph), the seat belt warning chime and corresponding warning light does not work even if you drive over 20 km/h (12 mph).

### Seat belt restraint system

#### Lap/shoulder belt

To fasten your seat belt:



Pull the belt out of the retractor and insert the metal tab (1) into the buckle (2). There An audible “click” sounds when the tab locks into the buckle. Make sure the seat belt is not twisted.



Place the lap belt (1) portion across your hips and the shoulder belt (2) portion across your chest.

The seat belt automatically adjusts to the proper length after the lap belt portion is adjusted manually so that it fits snugly around your hips. If you lean forward in a slow, easy motion, the belt extends and moves with you.

If there is a sudden stop or impact, the belt will lock into position. It will also lock if you try to lean forward too quickly.

**NOTICE**

If you cannot smoothly pull the seat belt out from the retractor, firmly pull the seat belt out and release it. After release, the belt may be pulled out smoothly.

**⚠ WARNING**

Improperly positioned seat belts may increase the risk of serious injury in an accident. Take the following precautions when adjusting the seat belt:

- Position the lap portion of the seat belt as low as possible across your hips, not on your waist, so that it fits snugly. This allows your strong pelvic bones to absorb the force of the crash, reducing the chance of internal injuries.
- Position one arm under the shoulder belt and the other over the belt, as shown in the illustration.
- Always position the shoulder belt anchor into the locked position at the appropriate height.
- Never position the shoulder belt across your neck or face.

**Height adjustment**

Adjust the height of the shoulder belt so that it lies across your chest and midway over your shoulder nearest the door, not over your neck.

Adjust the height of the shoulder belt so that it lies across your chest and midway over your shoulder nearest the door, not over your neck.

To adjust the height of the seat belt anchor:

Front seat

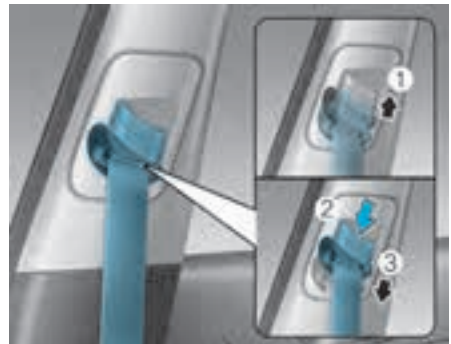

- Pull it up (1) to raise the height. To lower it, push it down (3) whilst pressing the height adjuster button (2). Release the button to lock the anchor in place. Try pushing the height adjuster down to make sure that it is locked in place.

### To release your seat belt:

Press the release button (1) in the locking buckle.



Once released, the belt should automatically draw back into the retractor. If this does not happen, check the belt to be sure it is not twisted, then try again.

### Rear centre seat belt (3-point rear centre seat belt)

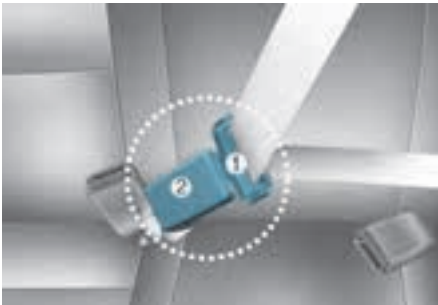

Insert the tongue plate (1) into the buckle (2) until an audible “click” is heard, indicating the latch is locked. Pull the shoulder portion of the belt to snug the belt across your hips and remove slack. Make sure the seat belt is not twisted.

When using the rear centre seat belt, use the buckle with the “CENTER” mark.

## *i* Information

If you cannot pull out the safety belt from the retractor, firmly pull the belt out and release it. After release, pull out the belt smoothly.

### *Pretensioner seat belt*

**+** if equipped



Your vehicle is equipped with driver's and front passenger's pretensioner seat belts (retractor pretensioner). The pretensioner makes sure the seat belts fit tightly against your body in certain frontal or side collision(s). The pretensioner seat belts may be activated in some crashes where the frontal or side collision(s) is severe enough, together with the airbags.

When the vehicle stops suddenly, or if you try to lean forward too quickly, the seat belt retractor locks in place.



In some frontal collisions, the pretensioner activates and pulls the seat belt against your body.

- (1) Retractor Pretensioner: The purpose of the retractor pretensioner is to make sure that the shoulder belts fit in tightly against the occupant's upper body in certain frontal or side collision(s).
- (2) Emergency Fastening Device System: The purpose of the Emergency Fastening Device System is to make sure that the pelvis belts fit in tightly against the occupant's lower body in certain frontal or side collision(s). If the system senses excessive tension on the driver or passenger's seat belt when the pretensioner system activates, the load limiter inside the retractor pretensioner will release some of the pressure on the affected seat belt.

### WARNING

To prevent serious injury or death:

- Always wear your seat belt and sit properly in your seat.
  - Do not use the seat belt if it is loose or twisted.
  - Do not place anything near the buckle.
  - Always replace your pretensioners after activation or an accident.
  - NEVER inspect, service, repair or replace the pretensioners by yourself. We recommend that the pretensioners be inspected, serviced, repaired, or replaced by a HYUNDAI authorised repairer.
  - Do not hit the seat belt assemblies.
- 

### WARNING

Do not touch the pretensioner seat belt assemblies for several minutes after they have been activated. When the pretensioner seat belt mechanism deploys during a collision, the pretensioner can become hot and can burn you.

---

### CAUTION

Body work on the front area of the vehicle may damage the pretensioner seat belt system. Therefore, we recommend the system to be serviced by a HYUNDAI authorised repairer.

---

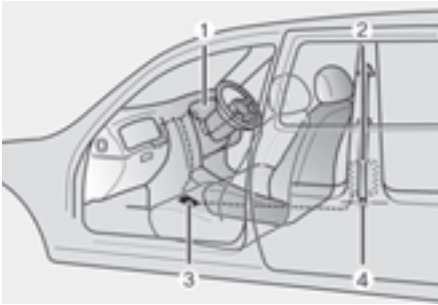

The pretensioner seat belt system consists mainly of the following components. Their locations are shown in the illustration above:

- (1) SRS airbag warning light
- (2) Retractor pretensioner assembly
- (3) SRS control module
- (4) Emergency Fastening Device (EFD) system (Driver only)

### NOTICE

The sensor that activates the SRS control module is connected with the pretensioner seat belt. The SRS airbag warning light on the instrument cluster illuminates for about 3-6 seconds after the Engine Start/Stop button is in the ON position, and then turns off.

If the pretensioner is not working properly, the warning light illuminates even if the SRS airbag is not malfunctioning. If the warning light does not illuminate when starting the engine or stays illuminated or illuminates whilst driving, we recommend the pretensioner seat belts and/or SRS control module be inspected by a HYUNDAI authorised repairer as soon as possible.

### *i* Information

- Pretensioner seat belts may be activated in certain frontal or side collisions or rollover situations.
- When the pretensioner seat belts are activated, a loud noise may be heard and fine dust, which may appear to be smoke, may be visible in the passenger compartment. These are normal operating conditions and are not hazardous.
- Although it is non-toxic, the fine dust may cause skin irritation and should not be inhaled for prolonged periods. Wash all exposed skin areas thoroughly after an accident in which the pretensioner seat belts were activated.

### Additional seat belt safety precautions

#### *Seat belt use during pregnancy*



The seat belt should always be used during pregnancy. The best way to protect your unborn child is to protect yourself by always wearing the seat belt.

Pregnant women should always wear a lap-shoulder seat belt. Place the shoulder belt across your chest, routed between your breasts and away from your neck. Place the lap belt below your belly and pull the shoulder portion so that it fits **SNUGLY** across your hips and pelvic bone, under the rounded part of your belly.

**⚠ WARNING**

- Pregnant women and patients are more vulnerable to any impacts on the abdomen during an abrupt stop or collision. If you are in an accident whilst pregnant, consult your doctor.
- To reduce the risk of serious injury or death to an unborn child during an accident, pregnant women should NEVER place the lap portion of the seat belt above or over the area of the abdomen where the unborn child is located.

***Seat belt use and children*****Infant and small children**

Most countries have Child Restraint System laws that require children to travel in approved Child Restraint System devices, including booster seats. The age at which seat belts can be used instead of Child Restraint System may be different among countries, so you should be aware of the specific requirements in your country, and where you are travelling. Infant and Child Restraint System must be properly placed and installed in a rear seat.

For more information refer to the “Seat belt safety precautions” section in this chapter.

**⚠ WARNING**

Always properly restrain infants and small children in a Child Restraint System appropriate for the child’s height and weight.

To reduce the risk of serious injury or death to a child and other passengers, never hold a child in your lap or arms when the vehicle is moving. Violent forces during a collision will tear the child from your arms and throw the child against the interior or to be ejected from the vehicle.

Small children are best protected from injury in an accident when properly restrained in the rear seat by a Child Restraint System that meets the requirements of the Safety Standards of your country. Before buying any Child Restraint System, make sure that it has a label certifying that it meets the applicable Safety Standards.

The Child Restraint System must be appropriate for your child’s height and weight. Check the label on the Child Restraint System for this information. Refer to the “Child Restraint System (CRS)” section in this chapter.

### Larger children

Children under age 13 and who are too large for a booster seat should always occupy the rear seat and use the available lap/shoulder belts. A seat belt should be snug against the hips and be snug across the shoulder and chest to restrain the child safely. A child's squirming could move the belt out of position. Adults should frequently check belt fit. In a collision, the safest place for children is in the rear seats, using a Child Restraint System appropriate for the child.

If a larger child over age 13 must be seated in the front seat, the child must be securely restrained by the available seat belt and the seat should be placed in the rearmost position.

If the shoulder belt portion slightly touches the child's neck or face, try placing the child closer to the centre of the vehicle. If the shoulder belt still touches their face or neck, the child needs to return to an appropriate booster seat in the rear seat.

### WARNING

- Always make sure larger children's seat belts are buckled and properly adjusted.
  - Never allow the shoulder belt to contact the child's neck or face.
  - Do not allow more than one child to use a single seat belt.
- 

### ***Seat belt use and injured people***

A seat belt should still be used when an injured person is being transported. Consult a physician for specific recommendations.

### ***One person per belt***

When two people (children or adults) are sitting together, never attempt to use a single seat belt. This could increase the severity of injuries in a collision.

### ***Do not lie down***

Sitting in a reclined position when the vehicle is moving can be dangerous. Even when buckled up, the protections of your restraint system (seat belts and/or airbags) is greatly reduced by reclining your seatback.

Seat belts must be snug against your hips and chest to work properly.

During a collision, you could be thrown into the seat belt, causing neck or other injuries.

The more the seat back is reclined, the greater the chance for the passenger's hips to slide under the lap belt or the passenger's neck to strike the shoulder belt.

### WARNING

- Never ride with a reclined seatback when the vehicle is moving.
- Riding with a reclined seatback increases your chance of serious or fatal injuries in the event of a collision or sudden stop.
- Driver and passengers should always sit well back in their seats with the seatbacks upright and should be belted properly.

## Care of seat belts

Seat belt systems should never be disassembled or modified.

### ***Periodic inspection***

All seat belts should be inspected periodically for wear or damage of any kind. Any damaged parts should be replaced as soon as possible.

### ***Keep belts clean and dry***

Seat belts should be kept clean and dry. If belts become dirty, they can be cleaned by using a mild soap solution and warm water. Bleach, dye, strong detergents, or abrasives should not be used because they may damage and weaken the fabric.

### ***When to replace seat belts***

The entire seat belt assembly or assemblies should be replaced if the vehicle has been involved in an accident. This should be done even if no damage is visible. We recommend that you contact a HYUNDAI authorised repairer for assistance.

## Child Restraint System (CRS)

### Our recommendation: Children always in the rear

### WARNING

Always properly restrain children in the vehicle. Children of all ages are safer when riding in the rear seats. Never place a rearward-facing Child Restraint System on the front passenger seat, unless the airbag is deactivated.

Children under age 13 should always ride in the rear seats and must always be properly restrained to minimise the risk of injury in a collision, sudden stop, or sudden manoeuvre.

According to accident statistics, children are safer when properly restrained in the rear seat than in the front seat. Children too large for a Child Restraint System must use the seat belts provided.

Most countries have child restraint regulations that require children to travel in approved Child Restraint Systems.

The laws governing the age or height/weight restrictions at which seat belts can be used instead of Child Restraint System differs among countries, so you should be aware of the specific requirements where you are travelling.

Child Restraint Systems must be properly installed in the vehicle seat. Use a commercially available Child Restraint System that meets the requirements of the Safety Standards of your country.

Child Restraint Systems are generally designed to be secured in a vehicle seat by a lap/shoulder seat belt, or by a top tether and/or ISOFIX anchorage in the rear seats of the vehicle.

### **Child Restraint System**

Infants and younger children must be restrained in an appropriate rearward-facing or forward-facing Child Restraint System that has first been properly secured to the seats of the vehicle. Read and comply with the instructions for installation and use provided by the manufacturer of the Child Restraint System.

#### **WARNING**

Do not use an improperly secured Child Restraint System. It may increase the risk of serious injury or death in a collision. When using a Child Restraint System:

- Always follow the Child Restraint System manufacturer's instructions for installation and use.
  - Always properly restrain your child in the Child Restraint System.
  - Do not use an infant carrier or a child safety seat that "hooks" over a seatback. It may not provide adequate protection in an accident.
  - After an accident, we recommend that your vehicle be inspected by a HYUNDAI authorised repairer to check the Child Restraint System, seat belts, ISOFIX anchorages, and top-tether anchorages.
- 

### **Selecting a Child Restraint System (CRS)**

When selecting a Child Restraint System for your child, always:

- Make sure the Child Restraint System has a label certifying that it meets applicable Safety Standards of your country.  
A Child Restraint System may only be installed if it was approved in accordance with the requirements of ECE-R44 or ECE-R129.
- Select a Child Restraint System based on your child's height and weight. The required label or the instructions for use typically provide this information.
- Select a Child Restraint System that fits the vehicle seating position where it is to be used.
- Read and comply with the warnings and instructions for installation and use provided with the Child Restraint System.

### **Child Restraint System types**

There are three main types of Child Restraint Systems: rearward-facing, forward-facing, and booster seat Child Restraint Systems.

They are classified according to the child's age, height, and weight.

### Rearward-facing Child Restraint System



With a rearward-facing Child Restraint System, the collision forces are absorbed by its shell instead of the child's body. The shell also supports the system's cradles and protects the head, neck and spine of the child. All children under the age of one year must always ride in a rearward-facing Child Restraint System. Convertible and 3-in-1 Child Restraint Systems typically have higher height and weight limits for the rearward-facing position, allowing you to keep your child rearward-facing for a longer period of time.

Continue using the Child Restraint Systems in the rearward-facing position as long as the child is within the height and weight limits allowed by the Child Restraint System's manufacturer. It's the best way to keep them safe. Once your child has outgrown the rearward-facing Child Restraint System, your child is ready for a forward-facing Child Restraint System with a harness.

### Forward-facing Child Restraint System



A forward-facing Child Restraint System provides restraint for the child's body with a harness. Keep children in a forward-facing Child Restraint System with a harness until they reach the top height or weight limit allowed by your Child Restraint System's manufacturer. Once your child outgrows the forward-facing Child Restraint System, your child is ready for a booster seat.

#### Booster seats

A booster seat is a Child Restraint System designed to improve the fit of the vehicle's seat belt system. A booster seat positions the seat belt so that it fits properly over the stronger parts of your child's body. Keep your children in booster seats until they are big enough to fit in a seat belt properly.

For a seat belt to fit properly, the lap belt must lie snugly across the upper thighs, not the stomach. The shoulder belt should lie snug across the shoulder and chest and not across the neck or face. Children under age 13 must always be properly restrained to minimise the risk of injury in an accident, sudden stop, or sudden manoeuvre.

## Installing a Child Restraint System

### WARNING

Before installing your Child Restraint System, always read and follow the instructions provided by the manufacturer of the Child Restraint System and in this manual to prevent serious injury or death if a collision occurs.

---

### WARNING

If the vehicle head restraint prevents proper installation of a Child Restraint System (as described in the Child Restraint System manual), readjust or remove the head restraint for that seating position

---

After selecting a proper Child Restraint System for your child and checking that the Child Restraint System fits properly in a seating position, there are three general steps for a proper installation:

- **Properly secure the Child Restraint System to the vehicle.** All Child Restraint Systems must be secured to the vehicle with a lap/shoulder belt or with an ISOFIX top-tether and/or ISOFIX anchorage and/or with a support leg.
- **Make sure the Child Restraint System is firmly secured.** After installing a Child Restraint System to the vehicle, push and pull the seat forwards and backwards and from side to side to verify that it is securely attached to the seat. Install a Child Restraint System secured with a seat belt as tightly as possible. Some side-to-side movement can be expected.

- **Secure the child in the Child Restraint System.** Make sure the child is properly strapped in the Child Restraint System according to the Child Restraint System manufacturer's instructions.

### CAUTION

Check the seating surface and buckles before placing your child in the Child Restraint System to prevent burns. A Child Restraint System in a closed vehicle can become very hot.

---

### Information

- If the vehicle head restraint prevents proper installation of a CRS, the head restraint of the seating position shall be readjusted or entirely removed.
  - Never place a rearward facing Child Restraint System on the front passenger seat, unless the airbag is deactivated.
- 

### ***ISOFIX anchorage and top-tether anchorage (ISOFIX anchorage system) for children***

The ISOFIX system connects a Child Restraint System to the vehicle during driving and in a collision. This system is designed to make installation of the Child Restraint System easier and reduce the possibility of improperly installing your Child Restraint System. The ISOFIX system uses anchors in the vehicle and attachments on the Child Restraint System. The ISOFIX system eliminates the need to use seat belts to secure the Child Restraint System to the rear seats.

ISOFIX anchorages are metal bars built into the vehicle. There are two lower anchors for each ISOFIX seating position that accommodates a Child Restraint System with lower attachments.



To use the ISOFIX system in your vehicle, install a Child Restraint System with ISOFIX attachments. (An ISOFIX Child Restraint System may only be installed if it has vehicle specific or universal approval in accordance with the requirements of ECE-R44 or ECE-R129.)

The Child Restraint System manufacturer provides you with instructions on how to use the Child Restraint System with its attachments for the ISOFIX anchorages.

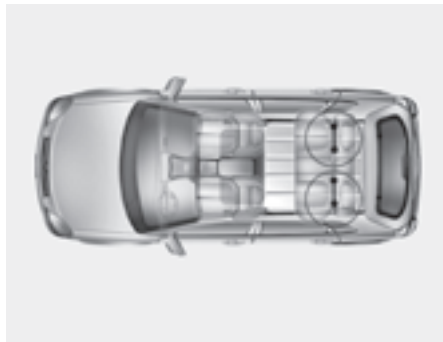

ISOFIX anchorages have been provided in the left and right outboard rear seating positions. Their locations are shown in the illustration. There are no ISOFIX anchorages provided for the centre rear seating position.

### WARNING

Do not attempt to install a Child Restraint System using ISOFIX anchorages in the rear centre seating position. There are no ISOFIX anchorages provided for this seat. Do not use the outboard seat anchors for the centre seat. It may damage the anchorages that may break or fail in a collision resulting in serious injury or death.

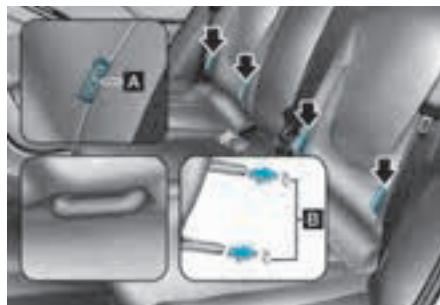

[A] ISOFIX anchorage position indicator  
[B] ISOFIX anchorage

The ISOFIX anchorage position indicator symbols are located on the left and right rear seatbacks to identify the positions of the lower rear anchors in your vehicle.

Both rear outboard seats are equipped with a pair of ISOFIX anchorages as well as a corresponding top-tether anchorage on the back side of the rear seats.

(Child Restraint Systems with universal approval according to ECE-R44 or ECE-R129 need to be fixed additionally with a top-tether connected to the back side of the rear seats.)

The ISOFIX anchorages are located between the seatback and the seat cushion of the rear seat left and right outboard seating positions.

### WARNING

Before installing the Child Restraint System, make sure that there are no objects (e.g. toys, pens, wires) near the ISOFIX anchorage area. Those objects may damage either the seat belt system or the Child Restraint System during installation. If necessary, we recommend that your vehicle be inspected by a HYUNDAI authorised repairer.

### **Securing a Child Restraint System with the ISOFIX Anchorage System**

To install an i-Size or ISOFIX-compatible Child Restraint System in either of the rear outboard seating positions:

1. Move the seat belt buckle away from the ISOFIX anchorages.
2. Move any other objects away from the anchorages that could prevent a secure connection between the Child Restraint System and the ISOFIX anchorages.
3. Place the Child Restraint System on the vehicle seat, then attach the seat to the ISOFIX anchorages according to the instructions provided by the Child Restraint System manufacturer.
4. Follow the instructions of the Child Restraint System's manufacturer for proper installation and connection of the ISOFIX attachments on the Child Restraint System to the ISOFIX anchorages.

#### **⚠ WARNING**

Take the following precautions when using the ISOFIX system:

- Read and follow all installation instructions provided with your Child Restraint System.
- To prevent the child from reaching and taking hold of unretracted seat belts, buckle all unused rear seat belts and retract the seat belt webbing behind the child. The child can be strangled if a shoulder belt becomes wrapped around their neck and the seat belt tightens.
- Never attach more than one Child Restraint System to a single anchorage. This may cause the anchorage or attachment to come loose or break.
- Always have the ISOFIX system inspected by your dealer after a collision. A collision can damage the ISOFIX system and may not properly secure the Child Restraint System.

### **Securing a Child Restraint System seat with Top Tether Anchorage system**



First secure the child restraint with the ISOFIX anchorages or the seat belt. If the child restraint manufacturer recommends that the top tether strap be attached, attach and tighten the top tether strap to the top tether strap anchorage.

Top tether anchorages are located on the rear of the seatbacks.



To install the top tether anchor:

1. Route the Child Restraint System top tether strap over the seatback. Route the tether strap under the head restraint and between the head restraint posts, or route the top tether strap over the top of the vehicle seatback. Make sure the strap is not twisted.

2. Connect the top tether strap hook to the top tether anchorage, then tighten the top tether strap according to the instructions of your Child Restraint System's manufacturer to firmly secure the Child Restraint System.
3. Check the Child Restraint System is secure by pushing and pulling the seat forward and back and side-to-side.

### **WARNING**

Take the following precautions when installing the top tether anchorage:

- Read and follow all installation instructions provided with your Child Restraint System.
- Never attach more than one Child Restraint System to a single ISOFIX top tether anchorage. This could cause the anchorage or attachment to come loose or break.
- Only attach the top tether strap to the correct top tether anchorage for that seating position.
- Child Restraint System anchorages are designed to withstand only those loads imposed by correctly fitted Child Restraint System.

Under no circumstances are they to be used for adult seat belts or harnesses or for attaching other items or equipment to the vehicle.

### **Securing a Child Restraint System with a lap/shoulder belt**

When not using the ISOFIX system, all Child Restraint Systems must be secured to a rear seat using the lap/shoulder belt.

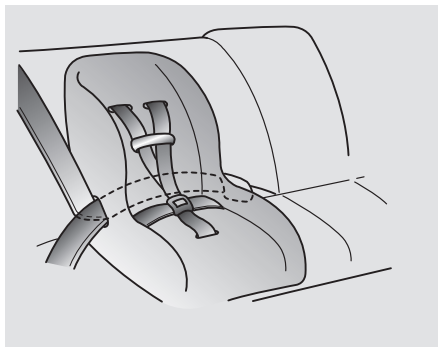

### **Installing a Child Restraint System with a lap/shoulder belt**

To install a Child Restraint System on the rear seats:

1. Place the Child Restraint System on a rear seat and route the lap/shoulder belt around or through the Child Restraint System, following the Child Restraint System manufacturer's instructions. Make sure the seat belt webbing is not twisted.

2. Fasten the lap/shoulder belt latch into the buckle. Listen for the distinct “click” sound.



### **i** Information

Position the release button so that it is easy to access in an emergency.



3. Remove as much slack from the belt as possible by pushing down on the Child Restraint System whilst feeding the shoulder belt back into the retractor.
4. Push and pull on the Child Restraint System to confirm that the seat belt is holding it firmly in place.

If your Child Restraint System manufacturer instructs or recommends you to use a top tether anchorage with the lap/shoulder belt, refer to “Securing a Child Restraint System seat with Top Tether Anchorage system” section for more information.

To remove the Child Restraint System, press the release button on the buckle and then pull the seat belt out of the Child Restraint System and allow the seat belt to retract fully.

### **Child Seat Restraint for Vehicle ISOFIX Positions**

Use child safety seats that have been officially approved and are appropriate for your children. When using the child safety seats, refer to following table:

Mass Group		Seating Position (or other side)				
		Front Passenger	Rear Outboard	Rear Center	Immediate Outboard	Immediate Center
Group 0	Up to 10 kg	X	U	X	-	-
Group 0+	Up to 13 kg	X	U	X	-	-
Group I	9 to 18 kg	X	U	X	-	-
Group II	15 to 25 kg	X	U	X	-	-
Group III	22 to 36 kg	X	U	X	-	-

U = Suitable for “Universal” category Child Restraints Systems approved for use in mass group.

UF = Suitable for forward facing “universal” category restraints for use in this mass group.

X = Seat position not suitable for children in this mass group.

## Airbag - supplemental restraint system

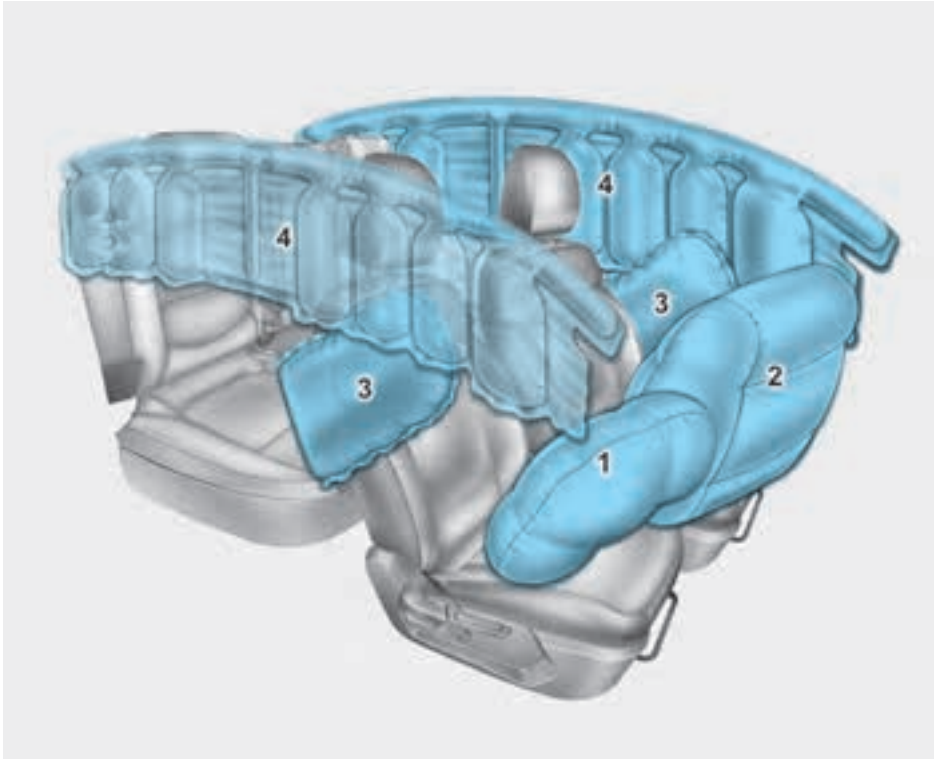

The actual airbags in the vehicle may differ from the illustration.

- (1) Driver's front airbag
- (2) Passenger's front airbag
- (3) Side airbag
- (4) Curtain airbag

Your vehicle is equipped with a Supplemental Airbag System for the driver's and front passenger's seats.

The front airbags are designed to supplement the three-point seat belts. For these airbags to provide protection, seat belts must be properly worn at all times when driving.

You can be severely injured or killed in an accident if you are not wearing a seat belt. Airbags are built into the vehicle as a supplementary system. They are not intended as a replacement for wearing 3-point seat belts. Also, airbags are not designed to deploy in every collision. In some accidents, the seat belts are the only restraint protecting you.

### WARNING

#### AIRBAG SAFETY PRECAUTIONS

- Always use seat belts Child Restraint Systems - every trip, every time, everyone! Even with airbags, you can be seriously injured or killed in a collision if you are improperly belted or not wearing your seat belt when the airbag inflates.
  - Never place a child in any Child Restraint System or booster seat in the front passenger seat, unless the airbag is deactivated. An inflating airbag could forcefully strike the infant or child causing serious or fatal injuries.
  - ABC - Always Buckle Children under age 13 in the back seat. It is the safest place for children of any age to ride. If a child age 13 or older must be seated in the front seat, he or she must be properly belted and the seat should be moved as far back as possible.
- Make sure that all occupants sit upright with the seatback in an upright position, centred on the seat cushion with their seat belt on, legs comfortably extended, and their feet on the floor until the vehicle is parked and the vehicle is turned off. If an occupant is out of position during an accident, the rapidly deploying airbag may forcefully contact the occupant causing serious or fatal injuries.
  - Never sit or lean unnecessarily close to the airbags or lean against the door or centre console.
  - Move your seat as far back as possible from front airbags, whilst still maintaining control of the vehicle.
-

## SRS Components

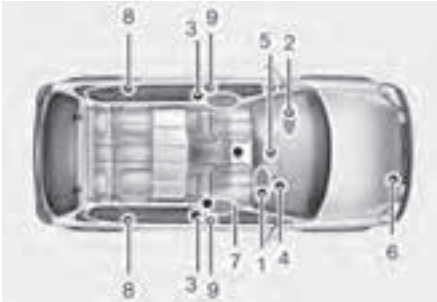

The SRS consists of the following components:

- (1) Driver's front airbag module
- (2) Passenger's front airbag module
- (3) Pre-tensioner seat belt system
- (4) Airbag warning light
- (5) SRS control module (SRSCM)
- (6) Front impact sensors
- (7) Side airbag modules
- (8) Curtain airbag modules
- (9) Side impact sensors

## Where are the airbags?

### ***Driver's and passenger's front airbags***

Driver's front airbag



Passenger's front airbag



The SRS consists of airbags located in the centre of the steering wheel and the passenger's side front panel pad above the glove box.

The airbag locations are embossed with the letters, "AIRBAG".

The purpose of the SRS is to provide the vehicle's driver and front passenger with additional supplemental protection that the seat belt system does not provide in case of a frontal impact of sufficient severity.



## WARNING

To reduce the risk of serious injury or death from inflating front airbags:

- Seat belts must be worn at all times to help keep occupants positioned properly.
- Move your seat as far back as possible from front airbags, whilst still maintaining control of the vehicle.
- Never lean against the door or centre console.
- Hold the steering wheel at the 9 o'clock and 3 o'clock positions, to minimise the risk of injuries to your hands and arms.
- Do not allow the front passenger to place their feet or legs on the dashboard.
- Never place any objects (such as dashboard cover, mobile phone holder, cup holder, perfume or stickers) over or near the airbag modules on the steering wheel, instrument panel, windscreen glass, and the front passenger's panel above the glove box. Such objects may cause harm if the vehicle is in a crash severe enough to cause the airbags to deploy.
- Do not attach any objects on the front windscreen and inside mirror.

## Side airbags

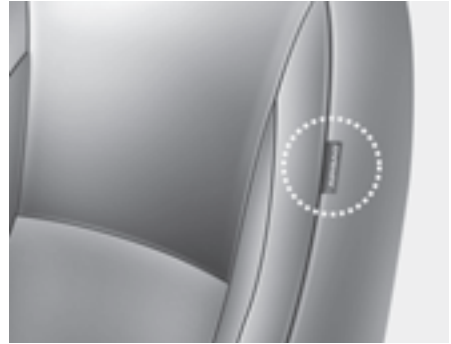

Side airbags are located in each front seat.

The side airbags are designed to deploy during certain side impact collisions, depending on the crash severity.

For the vehicle equipped with a rollover sensor, the side and/or curtain airbags and pretensioners on both sides of the vehicle are designed to deploy if a rollover or possible rollover is detected.

The side airbags are not designed to deploy in all side impact or rollover situations.

 **WARNING**

To reduce the risk of serious injury or death from an inflating side airbag:

- Seat belts must be worn at all times to help keep occupants positioned properly.
- Do not allow passengers to lean their heads or bodies onto doors, put their arms on the doors, stretch their arms out of the window, or place objects between the doors and seats.
- Do not use any accessory seat covers. It may reduce or prevent the effectiveness of the system.
- Do not hang other objects except clothes. In an accident it may cause vehicle damage or personal injury especially when air bag is inflated.
- Do not place any objects over the airbag location or between the airbag and yourself. Also, do not attach any objects around the area the airbag inflates such as door, side door glass, and front and rear pillar.
- Do not place any objects between the door and the seat. They may become dangerous projectiles if the side airbag inflates.
- Do not install any accessories on the side or near the side airbags.
- Do not cause an impact to the doors when the Engine Start/Stop button is in the ON or START position because the side airbags can inflate.
- If the seat or seat cover is damaged, we recommend to have the vehicle serviced by a HYUNDAI authorised repairer.

### **Curtain airbags**



Curtain airbags are located along both sides of the roof rails above the front and rear doors.

They are designed to help protect the heads of the front seat occupants and the rear outboard seat occupants in certain side impact collisions.

The curtain airbags are designed to deploy during certain side impact collisions, depending on the crash severity.

For the vehicle equipped with a rollover sensor, the side and/or curtain airbags and pretensioners on both sides of the vehicle may deploy if a rollover or possible rollover is detected.

The curtain airbags are not designed to deploy in all side impact or rollover situations.

## WARNING

To reduce the risk of serious injury or death from an inflating curtain airbag:

- Seat belts must be worn at all times to help keep occupants positioned properly.
- Properly secure a Child Restraint System as far away from the door as possible.
- Do not place any objects over the air bag. Also, do not attach any objects around the area the air bag inflates such as door, side door glass, front and rear pillar, and roof side rail.
- Do not hang other objects except clothes, especially hard or breakable objects near air bag locations. In an accident, it may cause vehicle damage or personal injury.
- Do not allow passengers to lean their heads or bodies onto doors, put their arms on the doors, stretch their arms out of the window, or place objects between the doors and seats.
- Do not open or repair the side curtain airbags yourself. If necessary, we recommend that the airbag be inspected by a HYUNDAI authorised repairer.

## How does the airbags system operate?

The SRSCM (Supplemental Restraint System Control Module) continually monitors all SRS components whilst the Engine Start/Stop button is ON to determine if a crash impact is severe enough to require airbag deployment or pretensioner seat belt deployment.

During a moderate to severe frontal collision, sensors detect the vehicle's rapid deceleration. If the rate of deceleration is high enough, the SRSCM inflates the front airbags with the force needed.

The front airbags help protect the driver and front passenger by responding to frontal impacts in which seat belts alone cannot provide adequate restraint. When needed, the side airbags help provide protection in the event of a side impact or rollover by supporting the side upper body area.

- Airbags are activated (able to inflate if necessary) only when the Engine Start/Stop button is in the ON or START position, and it may be activated within 3 minutes after the engine is turned off.
- Airbags inflate in the event of certain frontal or side collisions to help protect the occupants from serious physical injury.
- There is no single speed at which the airbags will inflate. Generally, airbags are designed to inflate based upon the severity of a collision and its direction. Airbag deployment also depends on a number of other factors including vehicle speed, angles of impact and the density and stiffness of the vehicles or objects which your vehicle impacts during a collision. The determining factors are not limited to those mentioned above.

- The front airbags completely inflate and deflate in an instant. It is virtually impossible for you to see the airbags inflate during an accident. It is much more likely that you simply see the deflated airbags hanging out of their storage compartments after the collision.
- In addition to inflating in serious side collisions, vehicles equipped with a rollover sensor, side and/or curtain airbags inflate if the sensing system detects a rollover.

When a rollover is detected, curtain airbags remain inflated longer to help provide protection from ejection, especially when used in conjunction with the seat belts.
- To help provide protection, the airbags must inflate rapidly. The speed of airbag inflation is a consequence of extremely short time in which the airbag inflates between the occupant and the vehicle structures before the occupant impacts those structures. This speed of inflation reduces the risk of serious or life-threatening injuries and is thus a necessary part of airbag design.

However, the rapid airbag inflation may also cause injuries that include facial abrasions, bruises, and broken bones because the inflation speed also causes the airbags to expand with great force.
- There are even circumstances under which contact with the airbag may cause fatal injuries, especially when the occupant is positioned excessively close to the airbag.

### WARNING

To reduce the risk of serious injury or death from an inflating airbag:

- Never place a child restraint in the front passenger seat. Always properly restrain children under age 13 in the rear seats of the vehicle.
- Adjust the front passenger's and driver's seats as far to the rear as possible whilst allowing you to maintain full control of the vehicle.
- Hold the steering wheel with hands at the 9 o'clock and 3 o'clock positions.
- Never place anything or anyone between the airbag and the seat occupant.
- Do not allow the front passenger to place their feet or legs on the dashboard.

Driver's front airbag (1)



When the SRSCM detects a sufficiently severe impact to the front of the vehicle, it automatically deploys the front airbags.

Driver's front airbag (2)



Upon deployment, tear seam in the pad cover separates from the expansion of the airbags.

A fully inflated airbag, in combination with a properly worn seat belt, slows the driver's or the front passenger's forward motion, reducing the risk of head and chest injury.

Driver's front airbag (3)



Passenger's front airbag



After complete inflation, the airbag immediately starts deflating, enabling the driver to maintain forward visibility and steer or operate other controls.

#### **WARNING**

To prevent objects from becoming dangerous projectiles when the passenger's airbag inflates:

- Do not install or place any objects (drink holder, CD holder, stickers, etc.) on the front passenger's panel above the glove box where the passenger's airbag is located.
- Do not install a container of liquid air freshener near the instrument cluster or on the instrument panel surface.

## What to expect after an airbag inflates

After a frontal or side airbag inflates, it deflates very quickly. Airbag inflation does not prevent the driver from seeing out of the windscreen or being able to steer. Curtain airbags may remain partially inflated for some time after they deploy.

### **WARNING**

After an airbag inflates, take the following precautions:

- Open your windows and doors as soon as possible after impact to reduce prolonged exposure to the powder released by the inflating airbag.
- Do not touch the airbag storage area's internal components immediately after an airbag has inflated. The parts that come into contact with an inflating airbag may be very hot.
- Always wash exposed skin areas thoroughly with cold water and mild soap.
- We recommend that a HYUNDAI authorised repairer inspect your vehicle and replace components as required before operating your vehicle again. Airbags are designed to be used only.

## Noise and smoke from inflating airbag

When the airbags inflate, they make a loud noise and may release powder inside the vehicle. After the airbag inflates, you may feel discomfort whilst breathing. This may be due to the impact of the airbag or the seat belt with your chest and it may also be due to breathing residual powder in the air and around your vehicle. The powder may aggravate asthma for some people. If you experience breathing problems after an airbag deployment, seek medical attention immediately.

Though the powder is nontoxic, it may cause irritation to the skin, eyes, nose, throat, etc. If this is the case, wash and rinse with cold water immediately and seek medical attention if the symptoms persist.

## Do not install a Child Restraint System on the front passenger's seat



Never install a Child Restraint System in the front passenger seat, unless the airbag is deactivated.

### **WARNING**

NEVER use a rearward facing Child Restraint on a seat protected by an ACTIVE AIRBAG in front of it, DEATH or SERIOUS INJURY to the CHILD can occur.

## SRS warning light



The SRS (Supplemental Restraint System) airbag warning light on the instrument panel displays the airbag symbol in the illustration. The light indicates if there is a potential problem with your airbag system, which could include your side and/or curtain airbags used for rollover protection (if equipped rollover sensor).

### WARNING

If your SRS malfunctions, the airbags may not inflate properly during a collision increasing the risk of serious injury or death.

Your SRS malfunctions in the following conditions:

- The light does not turn on for about three to six seconds when the ignition switch is in the ON position.
- The light stays on after illuminating for about three to six seconds.
- The light comes on whilst the vehicle is moving.
- The light blinks when the engine is running.

We recommend that a HYUNDAI authorised repairer inspect the SRS as soon as possible.

---

## Why didn't my airbag go off in a collision?

There are certain types of accidents in which the airbag would not deploy including rear impacts and second or third collisions in multiple impact accidents, as well as low speed impacts. Damage to the vehicle indicates a collision energy absorption, and is not an indicator of whether or not an airbag should have inflated.

### *Airbag collision sensors*

#### WARNING

To reduce the risk of an airbag deploying unexpectedly and causing serious injury or death:

- Do not hit or allow any objects to impact the locations where airbags or sensors are installed.
  - Do not perform maintenance on or around the airbag sensors. If the location or angle of the sensors is changed, the air bags may deploy when they should not or may not deploy.
  - Do not install bumper guards with non genuine Hyundai or non-equivalent parts. It may adversely affect the collision and airbag deployment performance.
  - Move the Engine Start/Stop button to the OFF or ACC position and wait for 3 minutes before the vehicle is towed to prevent unintended air bag deployment.
  - We recommend that all air bag repairs are conducted by a HYUNDAI authorised repairer.
-

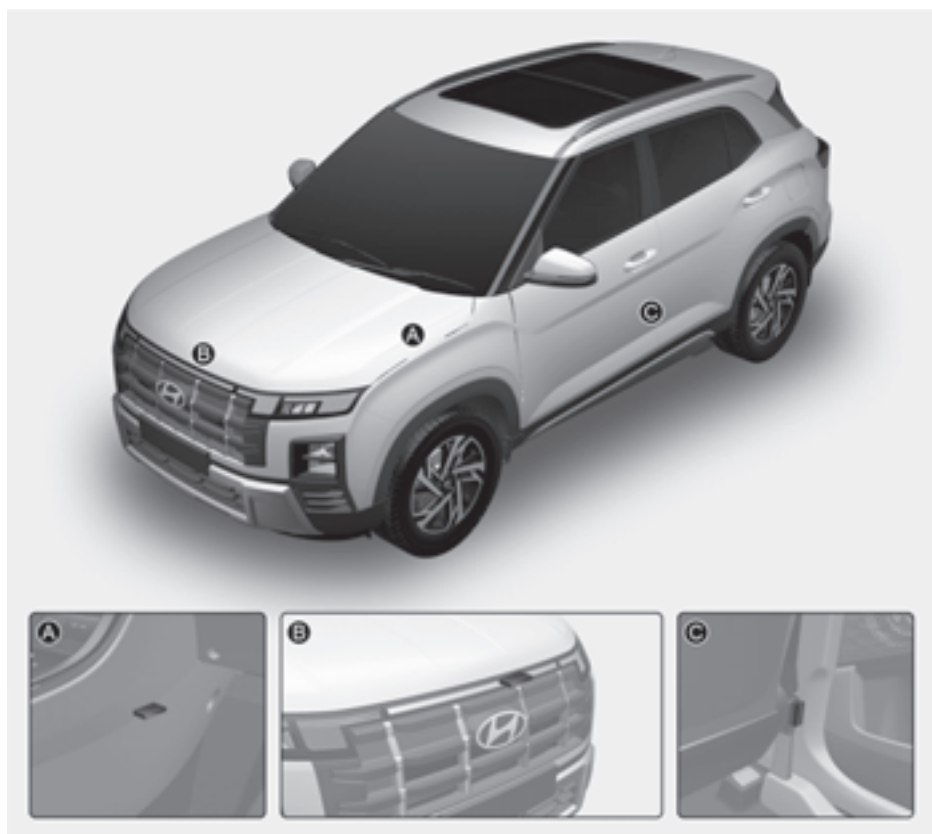

- [A] SRS control module
- [B] Front impact sensor
- [C] Side impact sensor



## Airbag inflation conditions

### Front airbags



Front airbags are designed to inflate in a frontal collision depending on the severity of impact.

### Side and curtain airbags



Side and curtain airbags are designed to inflate when an impact is detected by side collision sensors depending on the severity of impact resulting from a side impact collision.

Although the driver's and front passenger's airbags are designed to inflate in frontal collisions and side and curtain airbags are designed to inflate in side impact collisions, airbags may inflate in other types of collisions if the sensors detect a sufficient impact.

Also, the side and curtain airbags inflate when a rollover is detected by a rollover sensor.

If the vehicle chassis is impacted by bumps or objects on unimproved roads, the airbags may deploy. Drive carefully on unimproved roads or on surfaces not designed for vehicle traffic to prevent unintended airbag deployment.

**Airbag non-inflation conditions**



In certain low-speed collisions, the airbags may not deploy. The airbags are designed not to deploy in such cases because they may not provide benefits beyond the protection of the seat belts.



Front airbags are not designed to inflate in rear collisions, because occupants are moved backward by the force of the impact.



Front airbags may not inflate in side impact collisions, because occupants move in the direction of the collision. Side and curtain airbags may inflate depending on the severity of impact.



In an angled collision, the force of impact may direct the occupants in a direction where the airbags would not be able to provide any additional benefit, and thus the sensors may not deploy any airbags.

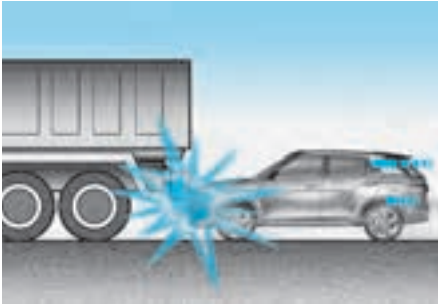

Just before impact, drivers often brake heavily. Such heavy braking lowers the front portion of the vehicle causing it to "nosedive". This is particularly important when the vehicle in front has a higher ground clearance. Airbags may not inflate if your vehicle is in a "nosedive" condition because the collision forces detected by the sensors may have been significantly reduced.



Front airbags may not inflate in rollover accidents because front airbag deployment would not provide additional occupant protection.



Airbags may not inflate if the vehicle collides with objects such as utility poles or trees, where the point of impact is concentrated and the collision energy is absorbed by the vehicle structure.

### SRS care

The SRS is virtually maintenance-free and there are no parts you can safely service by yourself. If the SRS airbag warning light does not illuminate when the Engine Start/Stop button is in the ON position or continuously remains on, we recommend that the system be immediately inspected by a HYUNDAI authorised repairer.

We recommend any work on the SRS system, such as removing, installing, repairing, or any work on the steering wheel, the front passenger's panel, front seats, and roof rails should be performed by a HYUNDAI authorised repairer. Improper handling of the SRS system may result in serious personal injury or death.



## WARNING

To reduce the risk of serious injury or death:

- Do not attempt to modify or disconnect the SRS components or wiring, including the addition of any kind of badges to the pad covers or modifications to the body structure.
  - Do not place objects over or near the airbag modules on the steering wheel, instrument panel, and the front passenger's panel above the glove box.
  - Clean the airbag pad covers with a soft cloth moistened with water. Solvents or cleaners may adversely affect the airbag covers and proper deployment of the system.
  - We recommend that inflated airbags be replaced by a HYUNDAI authorised repairer.
  - If components of the airbag system must be discarded, or if the vehicle must be scrapped, observe safety precautions. We recommend that you contact a HYUNDAI authorised repairer for the necessary information.
- 

## Additional safety precautions

**Passengers should not move out of or change seats whilst the vehicle is moving.** A passenger who is not wearing a seat belt during a collision or emergency stop can be thrown against the inside of the vehicle, against other occupants, or be ejected from the vehicle.

**Do not use any accessories on seat belts.** Devices claiming to improve occupant comfort or reposition the seat belt can reduce the protection provided by the seat belt and increase the chance of serious injury in a collision.

**Do not modify the front seats.** Modification of the front seats may interfere with the operation of the Supplemental Restraint System sensing components or side airbags.

**Do not place items under the front seats.** Placing items under the front seats may interfere with the operation of the Supplemental Restraint System sensing components and wiring harnesses.

**Do not cause impact to the doors.** Impact to the doors when the Engine Start/Stop button is in the ON or START position may cause the airbags to inflate.

### ***Adding equipment to or modifying your airbag equipped vehicle***

If you modify your vehicle by changing your vehicle's frame, bumper system, front end or side sheet metal, or ride height, this may affect the operation of your vehicle's Supplemental Restraint System.

### **Airbag warning label**



Airbag warning label is attached to alert the driver and passengers of potential risks of the airbag system. Be sure to read all of the information about the airbags that are installed on your vehicle in this Owners Manual.



# 4. Instrument Cluster

Instrument cluster .....	4-2
Instrument cluster control.....	4-4
Gauges and meters .....	4-4
Transmission shift indicator .....	4-8
Warning and indicator lights .....	4-9
Cluster display messages.....	4-24
Cluster display (Type A) .....	4-29
Cluster display control.....	4-29
Cluster display modes .....	4-30
User settings mode .....	4-33
Trip computer.....	4-38
Cluster display (Type B) .....	4-40
Cluster display control.....	4-40
View modes.....	4-40
Vehicle settings (infotainment system) .....	4-43
Setting your vehicle .....	4-44

## Instrument cluster

Type A



The actual cluster in the vehicle may differ from the illustration.  
For more information, refer to the “Gauges and meters” section in chapter 4.

- (1) Tachometer
- (2) Speedometer
- (3) Engine coolant temperature gauge
- (4) Fuel gauge
- (5) Warning and indicator lights
- (6) Cluster display (including Trip computer)



Type B



Type B (N Line)



The actual cluster in the vehicle may differ from the illustration.  
For more information, refer to the “Gauges and meters” section in chapter 4.

- (1) Tachometer
- (2) Speedometer
- (3) Engine coolant temperature gauge
- (4) Fuel gauge
- (5) Warning and indicator lights
- (6) Cluster display (including Trip computer)

## Instrument cluster control

### Instrument panel illumination



You can adjust the brightness of the instrument panel illumination from the User Settings Mode on the instrument cluster when the ignition switch is on ('**Lights > Illumination**'). When the vehicle's parking lights or headlights are on, interior switch illumination intensity and mood lamps are also adjusted.

### **i** Information

The infotainment system may change after software updates. For more information, refer to the manual provided in the infotainment system and the quick reference guide.

### **⚠** WARNING

Never adjust the instrument cluster whilst driving. This could result in loss of control and lead to an accident that may cause death, serious injury, or vehicle damage.

- The brightness of the instrument panel illumination is displayed.
- If the brightness reaches to the maximum or minimum level, a chime will sound.

## Gauges and meters

### Speedometer

Type A



Type B



Type B (N Line)



The speedometer indicates the speed of the vehicle and is calibrated in kilometers per hour (km/h) and/or miles per hour (MPH).

## Tachometer

Type A



Type B/Petrol



Type B/Diesel



The tachometer indicates the approximate number of engine revolutions per minute (RPM).

Use the tachometer to select the correct shift points and to prevent lugging and/or over-revving the engine.

## NOTICE

Do not operate the engine within the tachometer's RED ZONE. This may cause severe engine damage.

## Engine Coolant Temperature Gauge

Type A

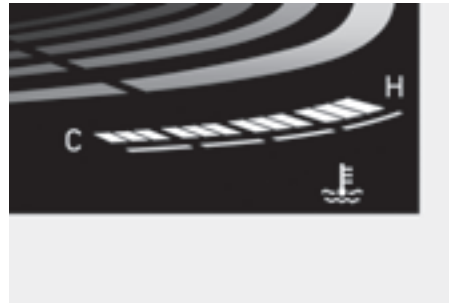

Type B



This gauge indicates the temperature of the engine coolant when the ignition switch is in the ON position.

## NOTICE

If the gauge pointer moves beyond the normal range area toward the "130 or H (Hot)" position, it indicates overheating that may damage the engine.

Do not continue driving with an overheated engine. If your vehicle overheats, refer to "If the engine overheats" in chapter 8.

**! WARNING**

Never remove the radiator cap or reservoir cap when the engine is hot. The engine coolant is under pressure and could cause severe burns. Wait until the engine is cool before adding coolant to the reservoir.

**Fuel Gauge**

Type A



Type B



This gauge indicates the approximate amount of fuel remaining in the fuel tank. Refer to “Cluster display (Type A)” section in chapter 4.

**i Information**

- The fuel tank capacity is given in chapter 2.
- The fuel gauge is supplemented by a low fuel warning light, which will illuminate when the fuel tank is nearly empty.
- On inclines or curves, the fuel gauge pointer may fluctuate or the low fuel warning light may come on earlier than usual due to the movement of fuel in the tank.

**! WARNING**

Running out of fuel can expose vehicle occupants to danger.

You must stop and obtain additional fuel as soon as possible after the warning light comes on or when the gauge indicator comes close to the “0 or E (Empty)” level.

**NOTICE**

Avoid driving with an extremely low fuel level. Running out of fuel could cause the engine to misfire damaging the catalytic converter.

### Outside Temperature Gauge

This gauge indicates the current outside air temperatures either in Celsius (°C) or Fahrenheit.

- Temperature range:
  - 40°C-60°C (-40°F-140°F)

The outside temperature on the display may not immediately change like a general thermometer not to distract the driver.

The temperature unit (from °C to °F or from °F to °C) can be changed by:

Type A

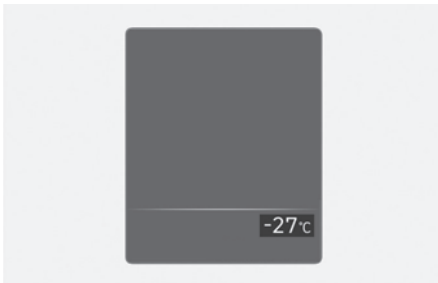

Type B

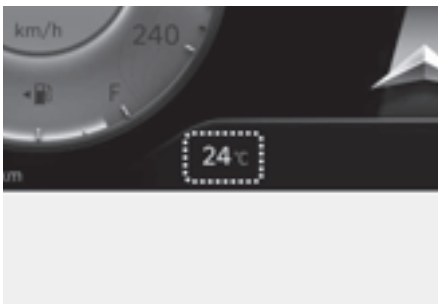

- User Settings mode in the Cluster: You can change the temperature unit in the “Other Temperature unit”
- Automatic climate control system: Whilst pressing the OFF button, press the AUTO button for 3 seconds or more.

The temperature unit of the instrument cluster and climate control system will change at once.

### Odometer

Type A

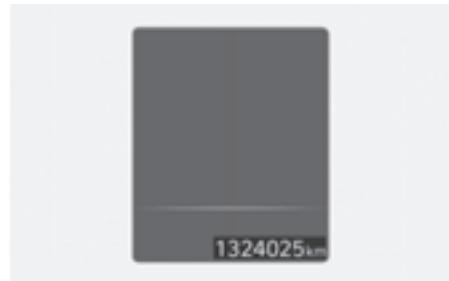

Type B

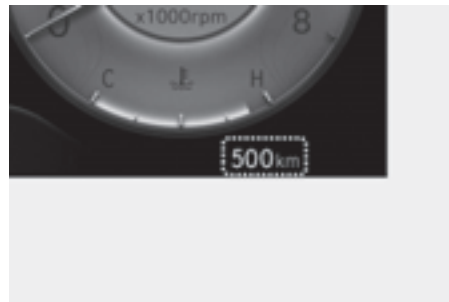

The odometer indicates the total distance that the vehicle has been driven and should be used to determine when periodic maintenance should be performed.

## Distance to empty

Type A

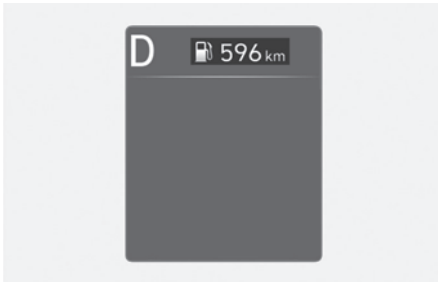

Type B

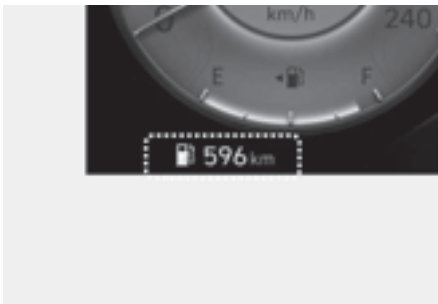

- The distance to empty is the estimated distance the vehicle can be driven with the remaining fuel.
- If the estimated distance is below 1km (1mi.), the trip computer will display “---” as distance to empty.

### **i** Information

- If the vehicle is not on level ground or the battery power has been interrupted, the distance to empty function may not operate correctly.
- The distance to empty may differ from the actual driving distance as it is an estimate of the available driving distance.
- The trip computer may not register additional fuel if less than 6 litres (15 US gal.) of fuel are added to the vehicle.
- The distance to empty may vary significantly based on driving conditions, driving habits, and condition of the vehicle.

## Transmission shift indicator

### Manual transmission shift indicator

if equipped

Type A

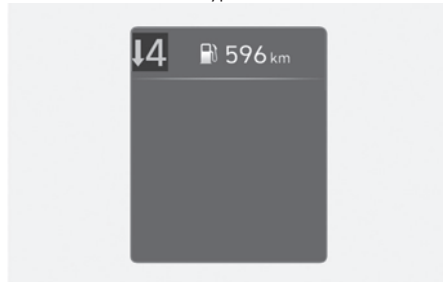

Type B

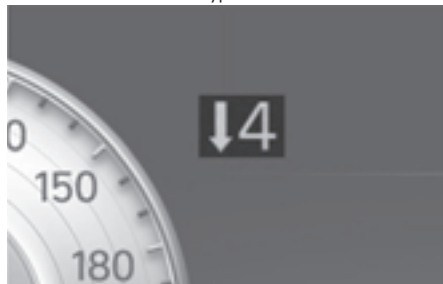

This indicator informs which gear is recommended whilst driving, to save fuel.

- Shifting up: ▲ 2, ▲ 3, ▲ 4, ▲ 5, ▲ 6
- Shifting down: ▼ 1, ▼ 2, ▼ 3, ▼ 4, ▼ 5

For example

▲4: Indicates that shifting up to the 4th gear is recommended (currently the shift lever is in the 3rd, 2nd, or 1st gear).

▼4: Indicates that shifting down to the 4th gear is recommended (currently the shift lever is in the 5th or 6th gear).

When the system is not working properly, the indicator is not displayed.

### **Automatic transmission shift indicator/Intelligent variable transmission/Dual clutch transmission shift indicator**

**+** if equipped

Type A

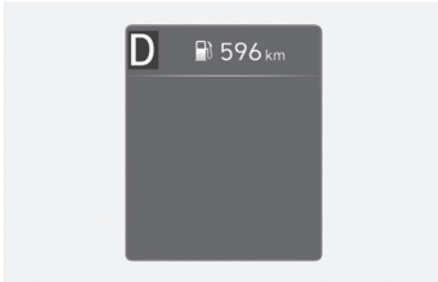

Type B

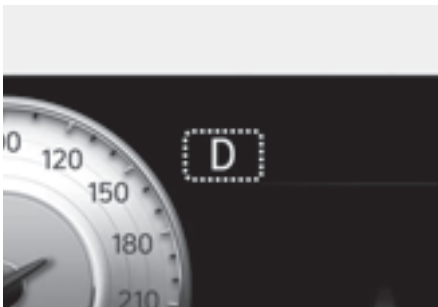

This indicator displays which shift lever position is selected.

## Warning and indicator lights

### **i** Information

Make sure that all warning lights are OFF after starting the engine. If any light is still ON, this indicates a situation that needs attention.

### **Air bag warning light**



#### **This warning light illuminates:**

- When you set the ignition switch to the ON position.
  - It illuminates for approximately 6 seconds and then goes off.
- When there is a malfunction with the SRS.
- In this case, we recommend that you have the vehicle inspected by a HYUNDAI authorised repairer.

### Seat belt warning light



This warning light informs the driver that the seat belt is not fastened.

For more information, refer to the "Seat belts" section in chapter 3.

### Parking Brake warning light



**This warning light illuminates:**

- When you set the ignition switch to the ON position.
  - It illuminates for approximately 3 seconds
  - It remains on if the parking brake is applied.
- When the parking brake is applied.
- When the brake fluid level in the reservoir is low.
  - If the warning light illuminates with the parking brake released, it indicates the brake fluid level in the reservoir is low.

**If the brake fluid level in the reservoir is low:**

1. Drive carefully to the nearest safe location and stop your vehicle.
2. With the engine stopped, check the brake fluid level immediately and add fluid as required (For more information, refer to the "Brake/clutch fluid" section in chapter 9). After adding brake fluid, check all brake components for fluid leaks. If a brake fluid leak is found, or if the warning light remains on, or if the brakes do not operate properly, do not drive the vehicle. We recommend that you have the vehicle inspected by a HYUNDAI authorised repairer.

### Dual-diagonal braking system

Your vehicle is equipped with dual-diagonal braking systems. This means you still have braking on two wheels even if one of the dual systems should fail.

With only one of the dual systems working, more than normal pedal travel and greater pedal pressure are required to stop the vehicle.

Also, the vehicle will not stop in as short a distance with only a portion of the brake system working.

If the brakes fail whilst you are driving, shift to a lower gear for additional engine braking and stop the vehicle as soon as it is safe to do so.

### **WARNING**

Parking Brake warning light

Driving the vehicle with a warning light ON is dangerous. If the Parking Brake warning light illuminates with the parking brake released, it indicates that the brake fluid level is low.

In this case, we recommend that you have the vehicle inspected by a HYUNDAI authorised repairer.

---



### **Anti-lock Brake System (ABS) warning light**



#### **This warning light illuminates:**

- When you set the ignition switch to the ON position.
  - It illuminates for approximately 3 seconds and then goes off.
- When there is a malfunction with the ABS (The normal braking system will still be operational without the assistance of the anti-lock brake system).

In this case, we recommend that you have the vehicle inspected by a HYUNDAI authorised repairer.

### **Electronic Brake Force Distribution System Warning Light**



#### **These two warning lights illuminate at the same time whilst driving:**

- When the ABS and regular brake system may not work normally.

In this case, we recommend that you have the vehicle inspected by a HYUNDAI authorised repairer.

### **! WARNING**

#### **Electronic Brake Force Distribution System Warning Light**

When both ABS and Parking Brake warning lights are on, the brake system will not work normally and you may experience an unexpected and dangerous situation during sudden braking.

In this case, avoid high speed driving and abrupt braking.

We recommend you have the vehicle inspected by a HYUNDAI authorised repairer as soon as possible.

---

### **i Information**

#### **Electronic Brake Force Distribution System Warning Light**

When the ABS Warning Light is on or both ABS and Parking Brake warning lights are on, the speedometer, odometer, or tripmeter may not work. Also, the MDPS Warning Light may illuminate and the steering effort may increase or decrease.

In this case, we recommend you have the vehicle inspected by a HYUNDAI authorised repairer as soon as possible.

---

### **Electronic Parking Brake (EPB) warning light**

 If equipped

# EPB

**This warning light illuminates:**

- When you set the ignition switch to the ON position.
  - It illuminates for approximately 3 seconds and then goes off.
- When there is a malfunction with the EPB.

In this case, we recommend that you have the vehicle inspected by a HYUNDAI authorised repairer.

### ***i* Information**

The Electronic Parking Brake (EPB) Warning Light may illuminate when the Electronic Stability control (ESC) Indicator Light comes on to indicate that the ESC is not working properly (This does not indicate malfunction of the EPB).

---

### **AUTO HOLD Indicator Light**

 If equipped

# AUTO HOLD

**This indicator light illuminates:**

- White: When you activate the auto hold system by pressing the AUTO HOLD button.
- Green: When you stop the vehicle completely by depressing the brake pedal with the auto hold system activated.
- Yellow: When there is a malfunction with the auto hold system.
- In this case, we recommend that you have the vehicle inspected by a HYUNDAI authorised repairer.

For more information, refer to the "Auto hold" section in chapter 6.

### **Motor Driven Power Steering (MDPS) warning light**



#### **This warning light illuminates:**

- When you set the ignition switch to the ON position.
  - It illuminates for approximately 3 seconds and then goes off.
- When there is a malfunction with the MDPS.

In this case, we recommend that you have the vehicle inspected by a HYUNDAI authorised repairer.

### **Malfunction Indicator Lamp (MIL)**



#### **This warning light illuminates:**

- When you set the ignition switch to the ON position.
  - It illuminates for approximately 3 seconds and then goes off.
- When there is a malfunction with the emission control system.

In this case, we recommend that you have the vehicle inspected by a HYUNDAI authorised repairer.

### **NOTICE**

- Driving with the Malfunction Indicator Lamp (MIL) on may cause damage to the emission control system which could affect drivability and/or fuel economy.
- If the enhanced engine protection system becomes activated due to lack of engine oil, engine power will be limited. If such condition continues repeatedly, the Malfunction Indicator Lamp will illuminate (Smartstream G1.5 T-GDi).

### **⚠ CAUTION**

If the Malfunction Indicator Lamp (MIL) illuminates, potential catalytic converter damage is possible which could result in loss of engine power.

In this case, we recommend that you have the vehicle inspected by a HYUNDAI authorised repairer as soon as possible.

### Exhaust system (GPF) warning light (for petrol engine)

 If equipped



- This warning light illuminates, when accumulated soot reaches a certain amount.
- When this warning light illuminates, it may turn off after driving the vehicle at more than 80 km/h (50 mph) for about 30 minutes (above 3rd gear with 1500-4000 engine RPM).

If this warning light blinks in spite of the procedure (at this time cluster display warning message will be displayed), we recommend that you have the GPF system checked by a HYUNDAI authorised repairer.

For more information, refer to the "9-83" section in chapter 9.

#### **NOTICE**

If you continue to drive with the GPF warning light blinking for a long time, the GPF system can be damaged and fuel consumption can worsen.

---

### Exhaust system (DPF or LNT) warning light (for diesel engine)

 If equipped



- This warning light illuminates, when there is a malfunction with the DPF or LNT system.
  - When this warning light illuminates, it may turn off after driving the vehicle:
    - at more than 60 km/h (37 mph), or
    - above 2nd gear with 1,250-2,500 engine rpm for a certain time (for about 30 minutes).
- If this warning light illuminates in spite of the procedure, we recommend that you have the DPF system checked by a HYUNDAI authorised repairer.
- When the exhaust gas captures exhaust gases over certain amount or the LNT performance is degraded.
    - In this case, the warning light illuminates and the warning alarm sounds whilst displaying the warning message "Self Regeneration" on the instrument cluster.

For more information, refer to the "9-83" section in chapter 9.

#### **NOTICE**

If you continue to drive with the DPF warning light blinking for a long time, the DPF system can be damaged and fuel consumption can worsen.

---

### SCR Warning light (for diesel engine)

 if equipped



#### This warning light illuminates:

When the urea solution tank is nearly empty.

If the urea solution tank is nearly empty, refill urea solution as soon as possible.

For more information, refer to the "9-83" section in chapter 9.

### Glow indicator light (for diesel engine)

 if equipped

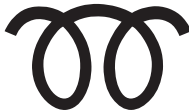

#### This warning light illuminates:

- When the engine is being preheated with the ignition switch or Engine Start/Stop button in the ON position.
  - The engine can be started after the glow indicator light goes off.
  - The illumination time varies depending on the with the engine coolant temperature, air temperature, and battery condition.

If the indicator light remains on or blinks after the engine has warmed up or whilst driving, there may be a malfunction with the engine preheating system.

In this case, we recommend that you have the vehicle inspected by a HYUNDAI authorised repairer.

### Information

If the engine does not start within 10 seconds after the preheating is completed, set the ignition switch or Engine Start/Stop Button to the LOCK or OFF position for 10 seconds and then to the ON position in order to preheat the engine again.

### Forward Safety warning light

 if equipped



#### This warning light illuminates:

- When you set the ignition switch to the ON position.
  - The Forward Safety warning light illuminates for approximately 3 seconds and then goes off.
- Continuously Yellow: When Forward safety of Forward Collision-Avoidance Assist is Off/Disabled/Malfunction.

#### The indicator light blinks:

- Red: When Forward safety of Forward Collision-Avoidance Assist is operating.

If this occurs, we recommend that you have the vehicle inspected by a HYUNDAI authorised repairer as soon as possible.

For more information, refer to the "Forward Collision-Avoidance Assist (FCA) (Sensor fusion)" section in chapter 7.

### **Lane Safety indicator light**

 if equipped



#### **This indicator light illuminates:**

- Green: When Lane Keeping Assist operating conditions are satisfied.
- Grey: When Lane Keeping Assist operating conditions are not satisfied.
- Yellow: Whenever there is Off/Disabled/Malfunction with Lane Keeping Assist.

If the yellow warning light remains on after the sensor has been uncovered or unblocked when Lane Safety is set, we recommend that your vehicle be inspected by a HYUNDAI authorised repairer.

#### **The indicator light blinks:**

- Green: When Lane Keeping Assist is operating.

For more information, refer to the "Lane Keeping Assist (LKA)" section in chapter 7.

### **Inattentive Warning light**

 if equipped



#### **This indicator light illuminates:**

- When you set the ignition switch or Engine Start/Stop button to the ON position.
- Yellow: When Driver Attention Warning is disabled or a malfunction is detected

If the yellow indicator light remains on after the front view camera has been uncovered or unblocked, we recommend that your vehicle be inspected by a HYUNDAI authorised repairer.

#### **This indicator light blinks:**

- Yellow: Driver Attention Warning recommends to take a break

For more information, refer to the "Driver Attention Warning (DAW)" section in chapter 7.

### Charging System Warning Light



This warning light illuminates:

- When there is a malfunction with either the alternator or electrical charging system

**If there is a malfunction with either the alternator or electrical charging system:**

1. Drive carefully to the nearest safe location and stop your vehicle.
2. Turn the engine off and check the alternator drive belt for looseness or breakage.

If the belt is adjusted properly, there may be a problem in the electrical charging system.

In this case, we recommend that you have the vehicle inspected by a HYUNDAI authorised repairer as soon as possible.

### Engine oil pressure warning light



This warning light illuminates:

- When the engine oil pressure is low.

**If the engine oil pressure is low:**

1. Drive carefully to the nearest safe location and stop your vehicle.
2. Turn the engine off and check the engine oil level (For more information, refer to the "Engine oil" section in chapter 9). If the level is low, add oil as required.

If the warning light remains on after adding oil or if oil is not available, we recommend that you have the vehicle inspected by a HYUNDAI authorised repairer as soon as possible.

Continued driving with the warning light on may cause engine failure.

### *i* Information

When engine oil pressure decreases due to insufficient engine oil, etc., the Engine Oil Pressure warning light will illuminate. In addition, the enhanced engine protection system which limits engine power will be activated (Smartstream G15 T-GDi). When the engine oil pressure is restored, the warning light and the enhanced engine protection system will turn off after the engine is restarted.

### **NOTICE**

If the engine does not stop immediately after the Engine Oil Pressure Warning Light is illuminated, severe damage could result.

### **AUTO STOP Indicator Light**

 if equipped



#### **This indicator light illuminates:**

When the engine enters the Idle Stop mode of ISG (Idle Stop and Go) system.

When the engine automatically starts, the AUTO STOP indicator on the cluster illuminates to white.

For more information, refer to the "6-51" section in chapter 6.

### **Low Fuel Level Warning Light**



#### **This warning light illuminates:**

- When the fuel tank is nearly empty. Add fuel as soon as possible.

#### **NOTICE**

Driving with the Low Fuel Level warning light on or with the fuel level below "E(Empty) or 0" can cause the engine to misfire and damage the catalytic converter (if equipped).

---

### **Over speed warning light**

 if equipped

**120**  
km/h

#### **This warning light blinks:**

- When you drive the vehicle more than 120 km/h.
  - This is to prevent you from driving your vehicle with overspeed.
  - The overspeed warning chime also sound for approximately 5 seconds.

### **Master warning light**



#### **This warning light illuminates:**

- When there is a malfunction in operation in any of the following systems:
  - Forward Collision-Avoidance Assist malfunction (if equipped)
  - Blind-Spot Collision-Avoidance Assist malfunction (if equipped)
  - Blind-Spot Collision-Avoidance Assist radar blocked (if equipped)
  - Smart Cruise Control malfunction (if equipped)
  - Smart Cruise Control radar blocked (if equipped)
  - LED head light malfunction (if equipped)
  - High Beam Assist malfunction (if equipped)

To identify the details of the warning, look at the instrument cluster.



### Low tyre pressure warning light



#### This warning light illuminates:

- When you set the ignition switch to the ON position.
  - It illuminates for approximately 3 seconds and then goes off.
- When one or more of your tyres are significantly underinflated (The location of the underinflated tyres are displayed on the cluster display).

For more information, refer to the "Tyre pressure monitoring system (TPMS)" section in chapter 8.

#### This warning light remains on after blinking for approximately 60 seconds or repeatedly blinks on and off at approximately 3 second intervals:

- When there is a malfunction with the TPMS.  
In this case, we recommend that you have the vehicle inspected by a HYUNDAI authorised repairer as soon as possible.

For more information, refer to the "Tyre pressure monitoring system (TPMS)" section in chapter 8.

### WARNING

#### Safe Stopping

- The TPMS cannot alert you to severe and sudden tyre damage caused by external factors.
- If you notice any vehicle instability, immediately take your foot off the accelerator pedal, apply the brakes gradually with light force, and slowly move to a safe position off the road.

### Electronic Stability Control Indicator Light



#### This indicator light illuminates:

- When you set the ignition switch to the ON position.
  - It illuminates for approximately 3 seconds and then goes off.
- When there is a malfunction with the ESC system.

In this case, we recommend that you have the vehicle inspected by a HYUNDAI authorised repairer.

#### This indicator light blinks:

- Whilst the ESC is operating.

For more information, refer to the "Electronic Stability Control (ESC)" section in chapter 6.

### Electronic Stability Control OFF Indicator Light



#### This indicator light illuminates:

- When you set the ignition switch to the ON position.
  - It illuminates for approximately 3 seconds and then goes off.
- When you deactivate the ESC system by pressing the ESC OFF button.

For more information, refer to the "Electronic Stability Control (ESC)" section in chapter 6.

### **Immobiliser Indicator Light (without smart key)**

 If equipped



#### **This indicator light illuminates:**

- When the vehicle detects the immobiliser in the key with the ignition switch in the ON position.
  - At this time, you can start the engine.
  - The indicator light goes off after starting the engine.

#### **This indicator light blinks:**

- When there is a malfunction with the immobiliser system.

In this case, we recommend that you have the vehicle inspected by a HYUNDAI authorised repairer.

### **Immobiliser Indicator Light (with smart key)**

 If equipped



#### **This indicator light illuminates for up to 30 seconds:**

- When the vehicle detects the smart key in the vehicle with the Engine Start/Stop button in the ACC or ON position.
  - At this time, you can start the engine.
  - The indicator light goes off after starting the engine.

#### **This indicator light blinks for a few seconds:**

- When the smart key is not in the vehicle.
  - At this time, you cannot start the engine

#### **This indicator light illuminates for 2 seconds and goes off:**

- If the smart key is in the vehicle and the Engine Start/Stop button is ON, but the vehicle cannot detect the smart key.

In this case, we recommend that you have the vehicle inspected by a HYUNDAI authorised repairer.

#### **This indicator light blinks:**

- When there is a malfunction with the immobiliser system.

In this case, we recommend that you have the vehicle inspected by a HYUNDAI authorised repairer.

### Turn Signal Indicator Light



#### This indicator light blinks:

- When you operate the turn signals.  
If any of the following occur, there may be a malfunction with the turn signal system.
  - The turn signal indicator light illuminates but does not blink
  - The turn signal indicator light blinks rapidly
  - The turn signal indicator light does not illuminate at all

If any of these conditions occur, we recommend that you have your vehicle inspected by a HYUNDAI authorised repairer.

### Low Beam Indicator Light

 if equipped



#### This indicator light illuminates:

- When the headlights are on.

### High Beam Indicator Light



#### This indicator light illuminates:

- When the headlights are on and in the high beam position.
- When the turn signal lever is pulled into the Flash-to-Pass position.

### High Beam Assist indicator light

 if equipped



#### This indicator light illuminates:

When the high-beam is on with the light switch in the AUTO light position.

- White: When High Beam Assist is ready to operate.
- Green: When High Beam Assist is operating.

If your vehicle detects oncoming or preceding vehicles, High Beam Assist will switch the high beam to low beam automatically.

For more information, refer to the "High Beam Assist (HBA)" section in chapter 5.

### Exterior Light Warning Light

 if equipped



This warning light illuminates:

- When one of the exterior bulbs (headlight, DRL, turn signal light, stop light, etc) is not operating properly. One of the bulbs may need to be replaced.

#### Information

Make sure to replace the burned out bulb with a new one of the same wattage rating.

### LED headlight warning light

 if equipped



This warning light illuminates:

- When you set the Engine Start/Stop button to the ON position.
  - The LED headlight warning light illuminates for approximately 3 seconds and then goes off.
- Whenever there is a malfunction with the LED headlight.

If this occurs, we recommend that you have your vehicle inspected by a HYUNDAI authorised repairer.

#### NOTICE

Continuous driving with the LED Headlight warning light on or blinking can reduce LED headlight life.

### Light ON indicator light



This indicator light illuminates:

- When the tail lights or headlights are on.

### Cruise Indicator Light

 if equipped



This indicator light illuminates:

- When the cruise control system is enabled.

For more information, refer to the "Cruise Control (CC)" section in chapter 7.

### SPORT Mode Indicator Light

 if equipped



This indicator light illuminates:

- When you select "SPORT" mode as drive mode.

For more information, refer to the "Drive mode integrated control system" section in chapter 6.

**ECO Mode Indicator Light**

+ if equipped

# ECO

**This indicator light illuminates:**

- When you select "ECO" mode as drive mode.

For more information, refer to the "Drive mode integrated control system" section in chapter 6.

**SMART Mode Indicator Light**

+ if equipped

# SMART

**This indicator light illuminates:**

- When you select "SMART" mode as drive mode.

For more information, refer to the "Drive mode integrated control system" section in chapter 6.

**Icy Road Warning Light**

+ if equipped



**This indicator light illuminates:**

This warning light is to warn the driver the road may be icy.

When the temperature on the outside temperature gauge is approximately below 4°C (40°F), the Icy Road Warning Light and Outside Temperature Gauge blinks and then illuminates. Also, the warning chime sounds 1time.

The Icy Road Warning function can be activated or deactivated from the User Settings mode in the instrument cluster.

**i Information**

If the icy road warning light appears whilst driving, you should drive more attentively and safely, refraining from over-speeding, rapid acceleration, sudden braking or sharp turning, etc.

## Cluster display messages

### **Key not in vehicle (for smart key system)**

This warning message is displayed if the smart key is not in the vehicle when you open or close door in the ACC position or ON position. The warning sound is heard when you close door without a smart key in vehicle.

When attempting to start the vehicle always have the smart key with you.

### **Key not detected (for smart key system)**

This warning message is displayed if the smart key is not detected when you press the Engine Start/Stop button.

### **Press START button with key (for smart key system)**

This warning message is displayed if you press the Engine Start/Stop button whilst the warning message “Key not detected” is displayed.

At this time, the immobiliser indicator light blinks.

### **Press START button again (for smart key system)**

This message is displayed if you were unable to start the vehicle when the Engine Start/Stop button was pressed.

If this occurs, attempt to start the engine by pressing the Engine Start/Stop button again.

If the warning message appears each time you press the Engine Start/Stop button, we recommend that you have your vehicle inspected by a HYUNDAI authorised repairer.

### **Low Key Battery (for smart key system)**

This warning message is displayed if the battery of the smart key is discharged whilst changing the Engine Start/Stop button to the OFF position.

### **Shift to P (for smart key system and automatic transmission/intelligent variable transmission/dual clutch transmission)**

This warning message is displayed if you try to turn off the engine without the shift lever in P (Park) position.

At this time, the Engine Start/Stop button turns to the ACC position (If you press the Engine Start/Stop button once more, it will turn to the ON position).

### **Press brake pedal to start engine (for smart key system and automatic transmission/intelligent variable transmission/dual clutch transmission)**

This warning message is displayed if the Engine Start/Stop button changes to the ACC position twice by pressing the button repeatedly without depressing the brake pedal.

You can start the vehicle by depressing the brake pedal.

### **Press clutch pedal to start engine (for smart key system and manual transmission)**

This warning message is displayed if the Engine Start/Stop button is in the ACC position twice by pressing the button repeatedly without depressing the clutch pedal.

Depress the clutch pedal to start the engine.

### ***Press START button again (for smart key system)***

This message is displayed if you were unable to start the vehicle when the Engine Start/Stop button was pressed.

If this occurs, attempt to start the engine by pressing the Engine Start/ Stop button again.

If the warning message appears each time you press the Engine Start/Stop button, we recommend that you have your vehicle inspected by a HYUNDAI authorised repairer.

### ***Check BRAKE SWITCH fuse (for smart key system and automatic transmission/intelligent variable transmission/dual clutch transmission)***

This warning message is displayed if the brake switch fuse is disconnected.

You need to replace the fuse with a new one. If that is not possible, you can start the engine by pressing the Engine Start/Stop button for 10 seconds in the ACC position.

### ***Shift to P or N to start engine (for smart key system and automatic transmission/intelligent variable transmission/dual clutch transmission)***

This warning message is displayed if you try to start the engine with the shift lever not in the P (Park) or N (Neutral) position.

#### ***i* Information**

You can start the engine with the shift lever in the N (Neutral) position. But, for your safety, we recommend that you start the engine with the shift lever in the P (Park) position.

### ***Battery discharging due to external electrical devices***

**+** if equipped

This message is displayed if the battery voltage is weak due to any non-factory electrical accessories (for example, dashboard camera) whilst parking. Be careful that the battery is not discharged.

If the warning message appears after removing the non-factory electrical accessories, we recommend that you have the vehicle inspected by a HYUNDAI authorised repairer.

### ***Door, Bonnet, Tailgate open indicator***

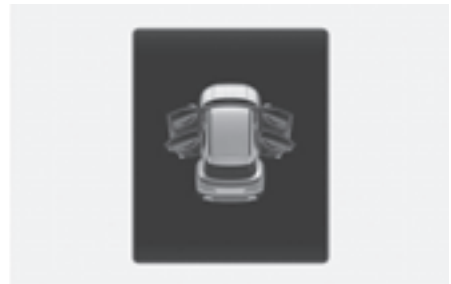

This warning is displayed indicating which door, or bonnet, or tailgate is open.

#### **⚠ CAUTION**

Before driving the vehicle, you should confirm that the door/bonnet/tailgate are fully closed. Also, check there is no door/bonnet/tailgate open warning light or message displayed on the instrument cluster.

### Sunroof open indicator

 if equipped



This warning is displayed if you turn off the engine when the sunroof is open. Close the sunroof securely when leaving your vehicle.

#### Information

The infotainment system may change after software updates. For more information, refer to the manual provided in the infotainment system and the quick reference guide.

### Lights mode

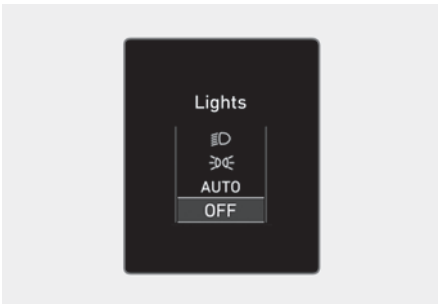

This indicator displays which exterior light is selected using the lighting control.

### Wiper mode



This indicator displays which wiper speed is selected using the wiper control.

### Low pressure

 if equipped

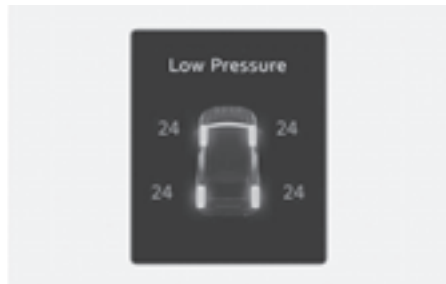

This warning message is displayed if the tyre pressure is low. The corresponding tyre on the vehicle will be illuminated.

For more information, refer to the "Tyre pressure monitoring system (TPMS)" section in chapter 8.



**Low washer fluid****+** if equipped

This warning message is displayed if the washer fluid level in the reservoir is nearly empty.

Have the washer fluid reservoir refilled.

**Low fuel**

This warning message is displayed if the fuel tank is almost out of fuel.

When this message is displayed, the low fuel level warning light in the cluster will come on.

It is recommended to look for the nearest fuelling station and refuel as soon as possible.

**Engine Overheated****+** if equipped

This warning message is displayed when the engine coolant temperature is above 120°C (248°F). This means that the engine is overheated and may be damaged.

If your vehicle is overheated, refer to “If the engine overheats” in chapter 8.

**Check exhaust system****+** if equipped

This message is displayed if there is a problem with the GPF, DPF or LNT system. At this time, the GPF warning light will also blink. If this occurs, we recommend that you have the exhaust system checked by a HYUNDAI authorised repairer.

GPF: Gasoline Particulate Filter

DPF: Diesel Particulate Filter

LNT: Lean NOx Trap

**Diesel filter regeneration required. See owner's manual****+** if equipped

- The DPF warning light illuminates if the exhaust gas captures exhaust gases over certain amount, sulfur in fuel or the engine oil is accumulated over certain amount in the LNT or the exhaust gas is accumulated over certain amount.
- In this case, the warning light illuminates and the warning alarm sounds whilst showing a warning message “Self Regeneration” on the instrument cluster.
- After the warning message appears for 10 seconds, it is stored in inspection message tap.

For more information, refer to the "9-83" section in chapter 9.

**Low urea (for diesel engine)****+** if equipped

This warning message illuminates if the urea solution level in the urea solution tank is nearly empty.

- When the SCR warning light is illuminates.

Refill urea solution as soon as possible.

For more information, refer to the "9-83" section in chapter 9.

**Check urea system (for diesel engine)****+** if equipped

This warning message illuminates if the urea system has a malfunction.

In this case, we recommend that you have the urea system checked by an authorised HYUNDAI dealer.

For more information, refer to the "9-83" section in chapter 9.

### **Check headlight**

 if equipped

This warning message is displayed if the headlights are not operating properly.

In addition, if a specific light (turn signal light etc.) is not operating properly, the warning message according to a specific light (turn signal light etc.) is displayed. A corresponding bulb may need to be replaced.

Make sure to replace the burned out bulb with a new one of the same wattage rating.

### **Check headlight (Low)**

 if equipped

This warning message is displayed if the headlight (Low) are not operating properly.

In addition, if a specific light (turn signal light etc.) is not operating properly, the warning message according to a specific light (turn signal light etc.) is displayed. A corresponding bulb may need to be replaced.

Make sure to replace the burned out bulb with a new one of the same wattage rating.

### **Check turn signal**

 if equipped

This warning message is displayed if the turn signal lights are not operating properly. A light may need to be replaced.

Make sure to replace the burned out bulb with a new one of the same wattage rating.

### **Check brake light**

 if equipped

This warning message is displayed if the stop lights are not operating properly. A light may need to be replaced.

Make sure to replace the burned out bulb with a new one of the same wattage rating.

### **Check daytime running light**

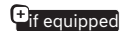
 if equipped

This warning message is displayed if the daytime running lights are not operating properly. A light may need to be replaced.

Make sure to replace the burned out bulb with a new one of the same wattage rating.

### **Check high mounted stop light**

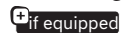
 if equipped

This warning message is displayed if the high mounted stop light are not operating properly. A light may need to be replaced.

Make sure to replace the burned out bulb with a new one of the same wattage rating.

### **Check headlight LED**

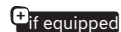
 if equipped

This warning message is displayed if there is a problem with the LED headlight. We recommend that you have the vehicle inspected by a HYUNDAI authorised repairer.



## Cluster display (Type A)

 if equipped

### Cluster display control



The cluster display modes can be changed by using the control switches.





- : MODE button for changing modes
- : MOVE switch for changing items
- : SELECT/RESET button for setting or resetting the selected item

### *i* Information

When the infotainment system is applied, only the User Settings mode on the infotainment system is supported but the User Settings mode on the instrument cluster is not supported.

---

## Cluster display modes

Modes	Symbol	Explanation
Trip Computer		This mode displays driving information such as the tripmeter, fuel economy, etc. For more details, refer to "Trip computer" in this chapter.
Turn By Turn (TBT)		This mode displays the state of the navigation.
Driving Assist		<ul style="list-style-type: none"> <li>• Lane Keeping Assist</li> <li>• Smart Cruise Control</li> <li>• Lane Following Assist</li> </ul>
User Settings		In this mode, you can change settings of the doors, lamps, etc.
Warning		This mode displays warning messages related to the light malfunction, tyre pressure information, etc.

**The information provided may differ depending on which functions are applicable to your vehicle.**

### ***Trip computer group***

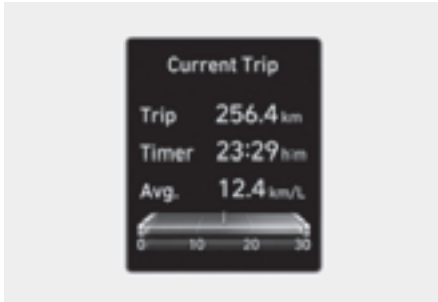

The trip computer group displays information related to vehicle driving parameters including fuel economy, tripmeter information and vehicle speed. For more details, refer to “Trip computer” in this chapter.

### ***Turn By Turn (TBT) group***

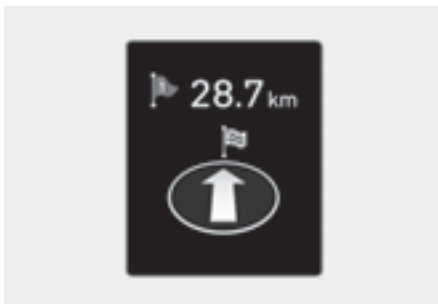

This group displays the state of the navigation.

### ***Driving Assist group***



#### **LKA/SCC**

This group displays the state of Lane Keeping Assist and Smart Cruise Control. For more details, refer to each function information in chapter 7.

### ***Master warning group***

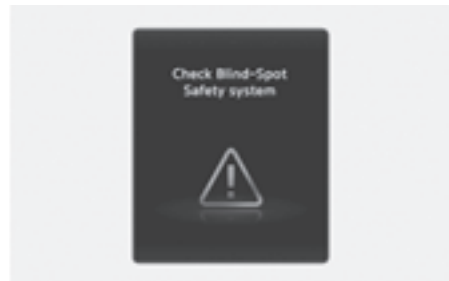

This warning light informs the driver the following situations.

- Forward Collision-Avoidance Assist malfunction (if equipped)
- Forward Collision-Avoidance Assist radar blocked (if equipped)
- Blind-Spot Collision-Avoidance Assist malfunction (if equipped)
- Blind-Spot Collision-Avoidance Assist radar blocked (if equipped)
- Lamp malfunction (if equipped)
- High Beam Assist malfunction (if equipped)

- Smart Cruise Control malfunction (if equipped)
- Tyre Pressure Monitoring System malfunction (if equipped)

The Master Warning Light illuminates if one or more of the above warning situations occur.

At this time, a Master Warning icon (⚠) will appear beside the User Settings icon (⚙), on the cluster display.

If the warning situation is solved, the master warning light will be turned off and the Master Warning icon will disappear.

### Tyre Pressure



This mode displays information related to Tyre Pressure.

For more details, refer to “Tyre pressure monitoring system (TPMS)” in chapter 8.

### Urea level (Diesel engine)



This mode displays the approximate amount of remaining urea solution inside the urea solution tank. Add the urea before the level indicates “E”.

For more details, refer to “Selective Catalytic Reduction (SCR)” in chapter 9.

## User settings mode

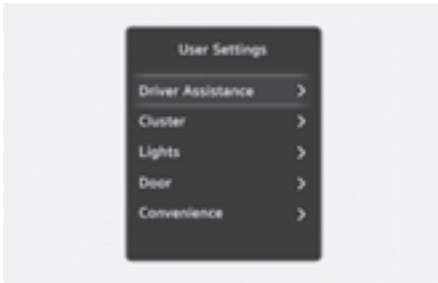

In this mode, you can change the settings of the instrument cluster, doors, lamps, etc.

1. Driver assistance
2. Door
3. Lights
4. Sound
5. Convenience
6. Service interval
7. Theme selection
8. Other
9. Language
10. Reset

The information provided may differ depending on which functions are applicable to your vehicle.

### Shift to P to edit settings/Engage parking brake to edit settings

This warning message illuminates if you try to select an item from the User Settings mode whilst driving.

- Automatic transmission/Intelligent variable transmission/Dual clutch transmission  
For your safety, change the User Settings after parking the vehicle, applying the parking brake and moving the shift level to P(Park).
- Manual transmission  
For your safety, change the User Settings after engaging the parking brake.

### Quick guide (Help)

This mode provides quick guides for the systems in the User Settings mode.

Select an item, press and hold the OK button.

For more details about each system, refer to this Owner's Manual.

### *i* Information

When the infotainment system is applied, only the User Settings mode on the infotainment system is supported but the User Settings mode on the instrument cluster is not supported.

1. Driver Assistance

Items	Explanation
Driving Convenience	<ul style="list-style-type: none"> <li>Smart Cruise Control To set the Distance, Acceleration, Reaction Speed of Smart Cruise Control. For more details, refer to the "Smart Cruise Control (SCC)" in chapter 7.</li> </ul>
Warning Methods	<p>To adjust the warning methods of the driver assistance system.</p> <ul style="list-style-type: none"> <li>Warning Volume: High/Medium/Low</li> </ul>
Driver Attention Warning	<ul style="list-style-type: none"> <li>Leading Vehicle Departure Alert To activate or deactivate the Leading vehicle departure alert. For more details, refer to the "Driver Attention Warning (DAW)" in chapter 7.</li> </ul>
Driving Safety	<ul style="list-style-type: none"> <li>Forward Safety To activate or deactivate the Forward Safety.</li> <li>Forward Safety Warning Timing To adjust the Forward Safety warning timing of the driver assistance system. For more details, refer to "Forward Collision-Avoidance Assist (FCA) (Sensor fusion)" in chapter 7</li> <li>Lane Safety To activate or deactivate the Lane Safety. For more details, refer to "Lane Keeping Assist (LKA)" in chapter 7.</li> <li>Blind-Spot Safety To activate or deactivate the Blind-Spot Safety. For more details, refer to "Blind-Spot Collision-Avoidance Assist (BCA)" in chapter 7.</li> <li>Exit Safety To activate or deactivate the Exit Safety. For more details, refer to "Safe Exit Warning (SEW)" in chapter 7.</li> </ul>
Parking Safety	<ul style="list-style-type: none"> <li>Parking Distance Warning Auto ON To activate or deactivate Parking Distance Warning Auto On. For more details, refer to "Forward/Reverse Parking Distance Warning (PDW)" in chapter 7.</li> <li>Rear Cross-Traffic Safety To activate or deactivate Rear Cross-Traffic Safety. For more details, refer to "Rear Cross-Traffic Collision-Avoidance Assist (RCCA)" in chapter 7.</li> </ul>

\* The information provided may differ depending on which functions are applicable to your vehicle.



## 2. Door

Items	Explanation
Auto Lock	<ul style="list-style-type: none"> <li>• Enable on Shift: All doors will be automatically locked if the automatic transmission/dual clutch transmission shift lever is moved from the P (Park) position to the R (Reverse), N (Neutral), or D (Drive) position. (Only when the engine is running)</li> <li>• Enable on Speed: All doors will be automatically locked when the vehicle speed exceeds 15 km/h (9.3 mph).</li> <li>• Disable: The auto door lock operation will be deactivated.</li> </ul>
Auto Unlock	<ul style="list-style-type: none"> <li>• On Shift to P: All doors will be automatically unlocked if the automatic transmission/dual clutch transmission shift lever is moved to P (Park) position. (Only when the engine is running)</li> <li>• On key out/Vehicle Off: All doors will be automatically unlocked when the ignition key is removed after the ignition switch is set to the LOCK/OFF position.</li> <li>• Disable: The auto door unlock operation will be cancelled.</li> </ul>
Horn Feedback	<p>To activate or deactivate the horn feedback.</p> <p>If the horn feedback is activated, after locking the door by pressing the lock button on the remote key, and pressing it again within 4 seconds, the horn feedback sound will operate once to indicate that all doors are locked (if equipped with remote key).</p>

## 3. Lights

Items	Explanation
Illumination	<p>To adjust the illumination level.</p> <ul style="list-style-type: none"> <li>• Level 1-20</li> </ul>
One Touch Turn Signal	<ul style="list-style-type: none"> <li>• Off: The one touch turn signal function will be deactivated.</li> <li>• 3, 5, 7 Flashes: The turn signal indicator will blink 3, 5, or 7 times when the turn signal lever is moved slightly.</li> </ul> <p>For more details, refer to “Exterior lights” in chapter 5.</p>
Headlight Delay	<ul style="list-style-type: none"> <li>• To activate or deactivate the headlight delay function.</li> </ul> <p>For more details, refer to “Exterior lights” in chapter 5.</p>
High Beam Assist	<ul style="list-style-type: none"> <li>• To activate or deactivate High Beam Assist.</li> </ul> <p>For more details, refer to “High Beam Assist (HBA)” in chapter 5.</p>

## 4. Sound

Items	Explanation
Welcome sound	To activate or deactivate the welcome sound.

5. Convenience

Items	Explanation
Welcome Mirror/Light	<ul style="list-style-type: none"> <li>On door unlock: The outside rearview mirrors are unfolded and the welcome light turns on automatically when the doors are unlocked.</li> <li>On driver approach: The outside rearview mirrors are unfolded and the welcome light turns on automatically when the vehicle is approached with the smart key.</li> </ul> For more details, refer to “Welcome system” in chapter 5.
Wireless Charging System	To activate or deactivate the wireless charging system in the front seat. For more details, refer to “5-77” in chapter 5.
Wiper/Lights Display	To activate or deactivate the Wiper/Light mode. When activated, the cluster display shows the selected Wiper/Light mode whenever you changed the mode.
Icy Road Warning	To activate or deactivate the icy road warning function.

6. Service interval

Items	Explanation
Enable Service Interval	To activate or deactivate the service interval function.

**i Information**

To use the service interval menu, we recommend that you consult a HYUNDAI authorised repairer.

If the service interval is activated and the time and distance is adjusted, messages are displayed in the following situations each time the vehicle is turned on.

- Service in  
: Displayed to inform the driver the remaining mileage and days to service.
- Service required  
: Displayed when the mileage and days to service has been reached or passed.

**i Information**

If any of the following conditions occur, the mileage and number of days to service may be incorrect.

- The battery cable is disconnected.
- The fuse switch is turned off.
- The battery is discharged.

### 7. Theme selection

To select the style of instrument cluster graphic style and setting.

- Theme A/Theme B/Theme C

### 8. Other

Items	Explanation
Speed Unit (if equipped)	To select the speed unit. (km/h, MPH)
Fuel Econ. Unit	To select the fuel economy unit. (km/L, L/100km, MPG)
Temperature Unit	To select the temperature unit. (°C, °F)
Tyre Pressure Unit	To select the tyre pressure unit. (psi, kPa, bar)

### 9. Language

 if equipped

Items	Explanation
Language	Choose the language. You can choose the language in infotainment system. (if equipped)

### 10. Reset

Items	Explanation
Reset	You can reset the menus in the User Settings Mode. All menus in the User Settings Mode are reset to factory settings, except language and service interval.

## Trip computer

The trip computer is a microcomputer-controlled driver information system that displays information related to driving.

### *i* Information

Some driving information stored in the trip computer (for example Average Vehicle Speed) resets if the battery is disconnected.

### Current trip

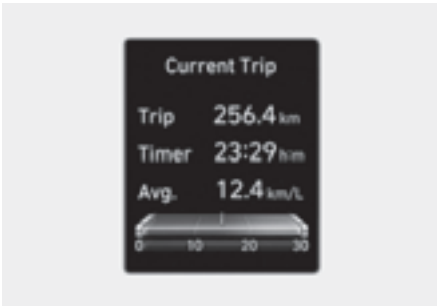

The trip computer mode displays information related to vehicle driving parameters including fuel economy, tripmeter information, and vehicle speed.

### Since refuelling



After the vehicle has been refueled, the trip distance, total driving time and average fuel economy appear.

To reset manually, press the **OK** button on the steering wheel for more than 1second when "**Since Refuelling**" appears.

### Since last reset



Accumulated trip distance, total driving time, and average fuel economy appear. The information is accumulated starting from the last reset.

To reset manually, press the **OK** button on the steering wheel for more than 1second when "**Since Reset**" appears.

### ***Digital speedometer***



This message shows the speed of the vehicle (km/h, MPH).

### ***Auto stop accumulated time***

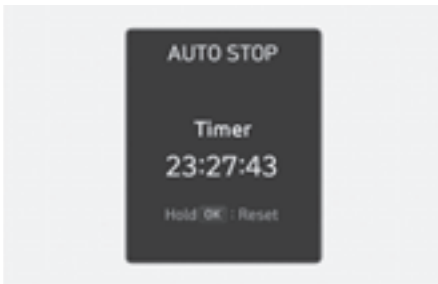

Displays the elapsed time of engine stop by the Idle Stop and Go system.



For more information, refer to the "6-51" section in chapter 6.

## Cluster display (Type B)

### Cluster display control



The cluster display modes can be changed by using the control switches.

Switch	Operation	Function
	Tap	MODE button for changing view modes
	Tap	MOVE switch for changing items
OK	Tap	SELECT/RESET button for setting the selected item
	Tap and hold	SELECT/RESET button for retrieving assist information or resetting the selected item

### *i* Information

When the infotainment system is applied, only the User Settings mode on the infotainment system is supported but the User Settings mode on the instrument cluster is not supported.

### View modes

View Modes	Explanation
Utility group	The Utility group displays driving information such as the trip distance, fuel economy and etc.
Driving assist group	The Driving Assist mode displays the driving status.
Navigation group	This mode displays the state of the navigation.
Driving info. group	Display for 4 seconds when the vehicle mode changes from IGN ON to OFF.

**The information provided may differ depending on which functions are applicable to your vehicle.**

### **Trip computer group**

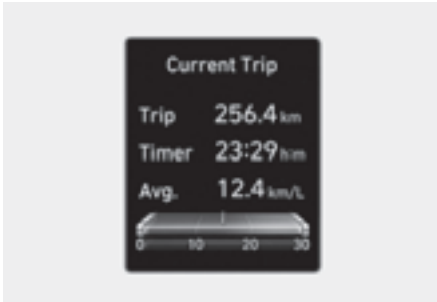

The trip computer group displays information related to vehicle driving parameters including fuel economy, tripmeter information and vehicle speed. For more details, refer to "Trip computer" in this chapter.

### **Turn By Turn (TBT) group**

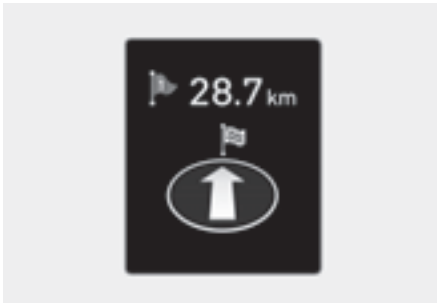

This group displays the state of the navigation.

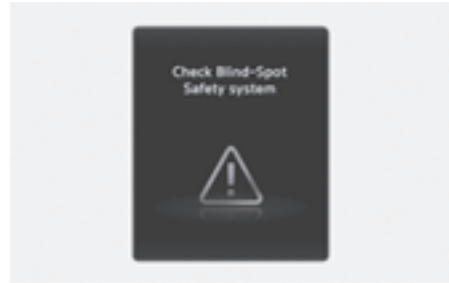

### **Master warning group**



This warning light informs the driver the following situations.

- Forward Collision-Avoidance Assist malfunction (if equipped)
- Forward Collision-Avoidance Assist radar blocked (if equipped)
- Blind-Spot Collision-Avoidance Assist malfunction (if equipped)
- Blind-Spot Collision-Avoidance Assist radar blocked (if equipped)
- Lamp malfunction (if equipped)
- High Beam Assist malfunction (if equipped)
- Smart Cruise Control malfunction (if equipped)
- Tyre Pressure Monitoring System malfunction (if equipped)

The Master Warning Light illuminates if one or more of the above warning situations occur.

At this time, a Master Warning icon () will appear beside the User Settings icon () on the cluster display.

If the warning situation is solved, the master warning light will be turned off and the Master Warning icon will disappear.

**Tyre Pressure**



This mode displays information related to tyre Pressure.  
For more details, refer to “Tyre pressure monitoring system (TPMS)” in chapter 8.

**Driving Assist group**



**SCC/LFA**

This group displays the state of Smart Cruise Control, Lane Following Assist.  
For more details, refer to each function information in chapter 7.

**Navigation group**

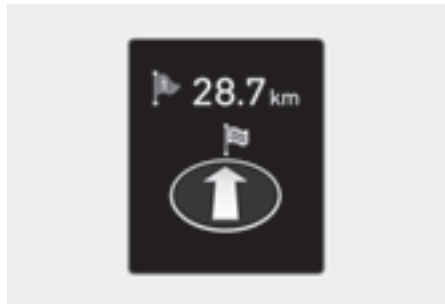

It shows the information by interworking with the navigation.

**Driving info. group**

**Driving information summary (1)**



The current operation conditions of Cruise Control, Smart Cruise Control and high speed driving assist modes. It does not show such information whilst driving assist mode is working.



### Driving information summary (2)



The current operation conditions of Cruise Control and Smart Cruise Control.

### **Warning message group**

When the warning message light appears, check the detailed information in warning message group.

## Vehicle settings (infotainment system)

 if equipped

Vehicle Settings in the infotainment system provides user options for a the settings including door lock/unlock features, convenience features, driver assistance settings, etc.

### Vehicle Settings menu

- Driver Assistance
- Cluster
- Climate
- Lights
- Door
- Convenience

The information provided may differ depending on which functions are available to your vehicle.

### **WARNING**

Do not adjust the Vehicle Settings whilst driving. You may be distracted from the driving task and could collide.

## Setting your vehicle



1. Press the **SETUP** button on the main keyboard.
2. Select **Vehicle** to change the settings for features.

### **i** Information

The infotainment system may change after software updates. For more information, refer to the manual provided in the infotainment system and the quick reference guide.

---

# 5. Convenience Features

Accessing your vehicle.....	5-4
Remote key.....	5-4
Smart key.....	5-7
Immobiliser system.....	5-13
MT (Manual Transmission) Remote start function .....	5-13
Door locks .....	5-15
Operating door locks from outside the vehicle .....	5-15
Operating door unlocks from inside the vehicle .....	5-15
Auto Door Lock/Unlock Features .....	5-17
Child-protector rear door locks .....	5-17
Theft-alarm system .....	5-18
Steering wheel .....	5-19
Motor Driven Power Steering (MDPS).....	5-19
Tilt/Telescopic steering .....	5-19
Horn .....	5-20
Mirrors .....	5-21
Inside rearview mirror.....	5-21
Outside rearview mirrors.....	5-22
Reverse parking aid .....	5-25
Windows.....	5-26
Power windows.....	5-27
Panorama sunroof .....	5-29
Power sunshade.....	5-30
Tilt open/close.....	5-30
Slide open/close .....	5-30
Automatic reversal.....	5-31
Resetting the sunroof .....	5-32
Sunroof open warning .....	5-32
Bonnet .....	5-33
Opening the bonnet.....	5-33
Closing the bonnet.....	5-34
Tailgate.....	5-34
Opening the tailgate .....	5-34
Closing the tailgate .....	5-35
Emergency tailgate safety release .....	5-35

Fuel filler door .....	5-36
Opening the fuel filler door.....	5-36
Closing the fuel filler door .....	5-37
Exterior lights .....	5-38
Lighting control .....	5-38
High beam operation .....	5-40
Turn signals and lane change signals .....	5-40
Battery saver function.....	5-41
Headlight escort function .....	5-41
Headlight levelling device .....	5-41
Headlight time-out function.....	5-42
Interior button lights .....	5-42
Daytime Running Light (DRL).....	5-43
Welcome system .....	5-43
High Beam Assist (HBA) .....	5-44
High Beam Assist settings .....	5-44
High Beam Assist operation .....	5-45
High Beam Assist malfunction and limitations .....	5-45
Interior lights .....	5-47
Interior lamp AUTO off.....	5-47
Front lights.....	5-47
Rear lamps .....	5-48
Cargo area lamp .....	5-49
Wipers and washers.....	5-49
Front windscreen wipers .....	5-50
Front windscreen washers.....	5-50
Rear windscreen wipers and washers .....	5-51
Manual climate control system.....	5-52
Heating and air conditioning .....	5-53
System operation .....	5-57
System maintenance .....	5-58
Automatic climate control system.....	5-59
Automatic heating and air conditioning .....	5-60
Manual heating and air conditioning .....	5-61
System maintenance .....	5-66
Windscreen defrosting and defogging.....	5-67

# 5. Convenience Features

Manual climate control system.....	5-67
Automatic climate control system.....	5-68
Defogging logic.....	5-69
Rear window defroster.....	5-69
Climate control additional features .....	5-70
Auto dehumidify .....	5-70
Sunroof inside air recirculation.....	5-70
Recirculating air when washer fluid is used.....	5-70
Recirculating air when entering a tunnel.....	5-71
Storage compartment.....	5-72
Centre console storage .....	5-72
Glove box.....	5-72
Cool box.....	5-73
Passenger seat open tray .....	5-73
Interior features .....	5-74
Cup holder.....	5-74
Sunvisor .....	5-74
Magnetic pad .....	5-75
Power outlet .....	5-75
USB charger.....	5-76
Wireless smartphone charging system.....	5-77
Clock .....	5-79
Floor mat anchor(s).....	5-79
Cargo area cover.....	5-80
Cargo tray .....	5-80
Exterior features .....	5-81
Roof rack.....	5-81
Infotainment system .....	5-81
USB port.....	5-81
Antenna .....	5-82
Steering wheel remote controls .....	5-82
Infotainment system.....	5-83
Voice recognition.....	5-83
Bluetooth® wireless technology .....	5-84
How vehicle radio works .....	5-84

## Accessing your vehicle

### Remote key

 if equipped



Your HYUNDAI uses a remote key that is used to lock or unlock the driver's and passenger's doors or the rear tailgate.

- (1) Door lock
- (2) Door unlock
- (3) Tailgate unlock

### Locking your vehicle

To lock :

1. Close all doors, bonnet and tailgate.
2. Press the Door Lock button (1) on the remote key. The doors are locked. The hazard warning lights blink. Also, the outside rearview mirror folds if **Settings > Vehicle > Lights > Welcome mirror/light > On door unlock** is selected from the infotainment system. (if equipped)
3. Make sure the doors are locked by pulling the outside door handle.

### WARNING

Do not leave the keys in your vehicle with children that are unattended or unsupervised.

Children could unintentionally place the key in the ignition switch or operate the power windows and other controls, or even cause the vehicle to move, resulting in serious injury or death.

### Unlocking your vehicle

To unlock:

1. Press the Door Unlock button (2) on the remote key.

The doors are unlocked. The hazard warning lights blink two times. Also, the outside rearview mirror unfolds if **Settings > Vehicle > Lights > Welcome mirror/light > On door unlock** is selected from the infotainment system. (if equipped)

### Information

- After unlocking the doors, the doors are locked automatically after 30 seconds unless a door is opened.
- The infotainment system may change after software updates. For more information, refer to the manual provided in the infotainment system and the quick reference guide.

### **Opening the tailgate**

Press and hold the Tailgate unlock button (3) for more than one second. The tailgate is unlocked. The hazard warning lights blink two times.

### **Starting the vehicle**

For more information, refer to the “6-5” section in chapter 6.

#### **NOTICE**

To prevent damaging the remote key:

- Keep the remote key away from liquids or any type of extreme heat. If water or liquid gets into the remote key or the remote is subjected to extreme heat, it may result in damage to the internal circuit. This could void the vehicle warranty.
- Avoid dropping or throwing the remote key.
- Protect the remote key from extreme temperatures.

### **Using the mechanical key**



If the remote key does not operate normally, you can lock or unlock the door by using the mechanical key.

To unfold the key, press the release button. The key unfolds automatically.

To fold the key manually, press the release button.

#### **NOTICE**

Do not fold the key without pressing the release button. The remote key may be damaged.

### Remote key precautions

The remote key may not work if any of the following occur:

- The key is in the ignition switch.
- The maximum operating distance limit is exceeded (about 10 m (30 ft.)).
- The remote key battery is weak.
- Other vehicles or objects may block the signals.
- The weather is extremely cold.
- The remote key is close to a radio transmitter such as radio station or airport that can interfere with normal operation of the remote key.

When the remote key does not work correctly, unlock and lock the door with the mechanical key. If you have a problem with the remote key, we recommend that you contact a HYUNDAI authorised repairer.

If the remote key is in close proximity to your mobile phone, the signals could be blocked by your mobile phone's operational signals.

This is especially important when the smartphone is active such as making and receiving calls, text messaging, and/or sending/receiving emails.

Avoid placing the remote key and your mobile phone in the same location and always try to maintain an adequate distance between the two devices.

### NOTICE

Keep the remote key away from electromagnetic materials that may block electromagnetic waves to the key surface.

---

### Replacing the battery



Battery type: CR2032

To replace the battery:

1. Insert a slim tool into the slot and gently open the cover.
2. Remove the old battery and insert the new battery. Make sure the battery position is correct.
3. Reinstall the rear cover of the remote key.

If you suspect your remote key might have sustained some damage or you feel your remote key is not working correctly, we recommend that you contact a HYUNDAI authorised repairer.

### WARNING

This product contains a button battery. If swallowed, a lithium button battery can cause severe or fatal injuries within 2 hours. Keep batteries out of reach of children.

If you think batteries may have been swallowed or placed inside any part of the body, seek immediate medical attention.

---



## *i* Information



An inappropriately disposed battery may be harmful to the environment and human health. Always dispose of a used battery according to your local law(s) and regulation.

## Smart key

if equipped

Type A



Type B



Your HYUNDAI uses a smart key that is used to lock or unlock the driver's and passenger's doors and the rear tailgate, and start the engine.

- (1) Door lock
- (2) Door unlock
- (3) Tailgate unlock
- (4) Remote start (if equipped)

## Locking your vehicle (1)

### Button type



1. Close all doors, bonnet, and tailgate.
2. Have the smart key with you.
3. Press the door handle button or press the Door Lock button (1) on the smart key. The hazard warning lights blink. Also, the outside rearview mirrors fold if **Settings > Vehicle > Lights > Welcome mirror/lights > On door unlock** or **On driver approach** is selected from the infotainment system.
4. Make sure the doors are locked by pulling the outside door handle.

### Touch sensor type

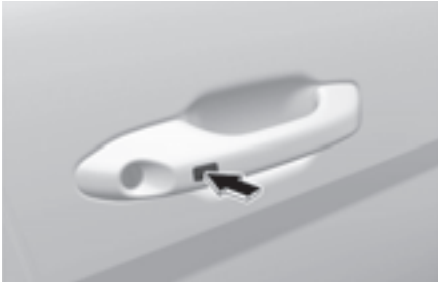

1. Close all doors, bonnet, and tailgate.
2. Have the smart key with you.
3. Touch the door handle touch sensor to activate the door lock or press the Door Lock button (1) on the smart key. The hazard warning lights blink. Also, the outside rearview mirrors fold if **Settings > Vehicle > Lights > Welcome mirror/light > On door unlock** or **On driver approach** is selected from the infotainment system.
4. Make sure the doors are locked by pulling the outside door handle.

### **i** Information

- The door handle button or touch sensor only operates when the smart key is within 40 inches (1m) from the outside door handle.
- If you lock the doors using the door handle button or touch sensor, the doors are not locked under the following circumstances:
  - The Smart Key is in the vehicle.
  - The Engine Start/Stop button is in the ACC or ON position.
  - Any door is open (except for the tailgate).

If this occurs, a chime sounds for about 3 seconds. Check the vehicle before attempting to lock the vehicle again.

---

### **i** Information

Before you leave your vehicle with the Smart Key, verify that your vehicle is locked. When using the touch sensor on the front door handle, listen to hear that the lock has actuated, and then pull the handle within 3 seconds to confirm the doors are locked.

(If it has been longer than 3 seconds, verify the doors are locked by pressing the lock button on the Smart Key. You can hear a single beep.)

---

### **!** WARNING

Do not leave the Smart Key in your vehicle with children that are unattended or unsupervised.

Children could unintentionally press the Engine Start/Stop button or could operate the power windows or other vehicle controls or even cause the vehicle to move. This may result in serious injury or death.

---

## Unlocking your vehicle (2)

### Button type



1. Have the smart key with you.
2. Press the door handle button or press the Door Unlock button (2) on the smart key. The hazard warning lights blink. Also, the outside rearview mirrors unfold if **Settings > Vehicle > Lights > Welcome mirror/light > On door unlock** or **On driver approach** is selected from the infotainment system.

### Touch sensor type



1. Have the smart key with you.
2. Grab the door handle to activate the door unlock touch sensor. The hazard warning lights blink two times. Also, the outside rearview mirrors unfold if **Settings > Vehicle > Lights > Welcome mirror/light > On door unlock** or **On driver approach** is selected from the infotainment system.

### *i* Information

The door handle button or touch sensor only operates when the smart key is within 40 inches (1m) from the outside door handle.

- After unlocking the doors, the doors are locked automatically after 30 seconds unless a door is opened.
- The infotainment system may change after software updates. For more information, refer to the manual provided in the infotainment system and the quick reference guide.

### *i* Information

- During a vehicle wash or rain, in order to minimise unintentional operation of the touch sensor, the touch sensor may become insensitive. This is not a malfunction.
- The doors may not lock or unlock in the following situations.
  - If the touch sensor is touched with gloves on.
  - If the door is suddenly approached.

### **Smart key reminder**

If the Smart key is in the vehicle, and the door is locked with the central door lock/unlock button in the vehicle with a door open, the doors are not locked but unlocked again.

### **Unlocking the tailgate (3)**

To unlock the tailgate:

1. Have the smart key with you.
2. Press the tailgate open button on the vehicle or press and hold the Tailgate open/close button (3) on the smart key for more than 1second. The hazard warning lights blinks two times.

#### ***i* Information**

The tailgate unlock button only operates when the smart key is within 40 inches (1 m) from the tailgate.

---

### **Stating the vehicle**

Some models are equipped with a Engine Start/Stop button instead of a key cylinder. You can leave your smart key in your pocket or purse when you start your vehicle. For more information, refer to the “Engine Start/Stop button” section in chapter 6.

#### ***i* Information**

If the smart key is not moved for some time, the detection function for smart key operation will pause. Lift the smart key to activate the detection again.

---

#### **NOTICE**

To prevent damaging the smart key:

- Keep the smart key in a cool, dry place to avoid damage or malfunction. Exposure to moisture or high temperature may cause the internal circuit of the smart key to malfunction. This may not be covered under warranty.
  - Avoid dropping or throwing the smart key.
  - Protect the smart key from extreme temperatures.
-

### **Key cylinder (Driver door)**

A key cylinder is located on the driver side door handle hidden behind a plastic cover. Using the mechanical key, push and hold the key cylinder cover release button located on the underside of the door handle.

Use the mechanical key inserted into the release button slot to open the cover outward. Once the cover is off, the mechanical key can be inserted into the key cylinder to lock or unlock the vehicle.

### **Mechanical key**

If the Smart Key does not operate normally, you can lock or unlock the door by using the mechanical key.



Press and hold the release button (1) and remove the mechanical key (2). Insert the mechanical key into the key hole on the door.

To reinstall the mechanical key, put the key into the hole and push it until a click sound is heard.

### **Loss of a smart key**

A maximum of two smart keys can be registered to a single vehicle. If you happen to lose your smart key, it is recommended that you should immediately take the vehicle and remaining key to your HYUNDAI authorised repairer or tow the vehicle, if necessary.

### **Smart key precautions**

The smart key may not work if any of the following occur:

- The smart key is close to a radio transmitter such as radio station or airport that may interfere with normal operation of the transmitter.
- The smart key is near a mobile two way radio system or a mobile phone.
- Another vehicle's smart key is being operated close to your vehicle.
- The smart key is near any normal electronic devices or credit cards.
- The vehicle battery is discharged.
- Connecting an external device to the power outlet and placing the smart key near the external device.
- If your windows are tinted, especially with metallic window tint, it may cause frequency interference, reducing the smart key operating range.

If the smart key does not work correctly, open and close the door with the mechanical key. To start the engine, press the Engine Start/Stop button directly with the smart key. If you have a problem with the smart key, it is recommended to contact a HYUNDAI authorised repairer.

If the smart key is in close proximity to your mobile phone, the signal could be blocked by your mobile phone's normal operational signals. This is specifically relevant when the phone is active such as making and receiving calls, text messaging, and/or sending/receiving emails. When possible, avoid keeping the smart key and your mobile phone in the same location such as a pants or jacket pocket to avoid interference between the two devices.

### NOTICE

- Keep the smart key away from electromagnetic materials that blocks electromagnetic waves to the key surface.
- Always have the smart key with you when leaving the vehicle. If the smart key is left near the vehicle, the vehicle battery may be discharged.

### Replacing the battery

Battery type: CR2032

To replace the battery:



1. Pry open the rear cover of the smart key.
2. Remove the old battery and insert a new battery. Make sure the battery position is correct.
3. Reinstall the rear cover of the smart key.

If you suspect your smart key might have sustained some damage or you feel your smart key is not working correctly, we recommended that you contact a HYUNDAI authorised repairer.

### ! WARNING

This product contains a button battery.

If swallowed, a lithium button battery can cause severe or fatal injuries within 2 hours. Keep batteries out of reach of children.

If you think batteries may have been swallowed or placed inside any part of the body, seek immediate medical attention.

---

### i Information



An inappropriately disposed battery may be harmful to the environment and human health. Always dispose of a used battery according to your local law(s) and regulations.

---

## Immobiliser system

The immobiliser system helps protect your vehicle from theft. If an improperly coded key (or other device) is used, the engine's fuel system is disabled.

When the Engine Start/Stop button is in the ON position, the immobiliser system indicator should come on briefly, then go off. If the indicator starts to blink, the system does not recognise the coding of the key.

Press the Engine Start/Stop button to the OFF position, then to the ON position again.

The system may not recognise your key's coding if another immobiliser key or other metal object (e.g. key chain) is near the key. The engine may not start because the metal may interrupt the transponder signal from transmitting normally.

If the system repeatedly does not recognise the coding of the key, we recommend that you contact a HYUNDAI authorised repairer.

Do not attempt to modify this system or add other devices to it. Electrical problems may occur making your vehicle inoperable.

### Disclaimer:

The system is designed in such a way that it makes vehicle theft difficult if its circuit and battery connection is uninterrupted.

### WARNING

To prevent theft of your vehicle, do not leave spare keys anywhere in your vehicle. Your immobiliser password is a customer unique password and should be kept confidential.

### NOTICE

Avoid exposing the key to moisture, static electricity, and rough handling. The immobiliser system may malfunction.

## MT (Manual Transmission) Remote start function

 if equipped

Remote Engine Start allows you to start your vehicle engine remotely from your convenient place by Mobile (Bluelink App).

The following conditions must be met for a vehicle to start remotely:

- All the vehicle doors including tailgate and bonnet must be closed and locked; EPB should be in applied (ON) state.



- Gear shift lever must be in N (Neutral) position.

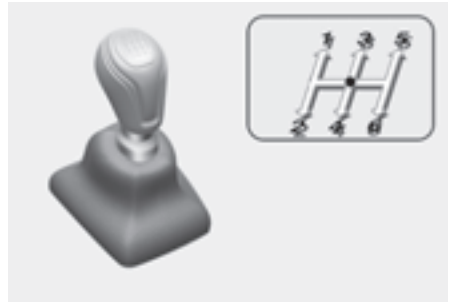

- Vehicle should be parked on a flat surface.



- Smart key should not be placed inside the vehicle.

### **Remote Engine Start will not operate:**

- If gear position is other than N (Neutral).
- If EPB state is in release (OFF) state.
- If vehicle is parked on a hill or an inclination road (not on flat area).
- If vehicle battery is low.

### **CAUTION**

For remote start operation in Manual Transmission, vehicle must be parked on a flat surface.

---

### Door lock/unlock sound

When a user steps out of the vehicle, all doors are closed and then the user tries to lock or unlock the vehicle with the remote key or smart key, sound occurs along with flashing.

- Door lock beep sound : 1time
- Door unlock beep sound : 2 times

### **Lock/Unlock Sound Function Disable/Enable:**

The user can disable or enable the lock/unlock sound using the remote key or smart key.

- Default condition: Sound is Enabled (ON)
  - Sound Disable : User must press both lock and unlock buttons in the remote key or smart key together for at least 4 seconds to deactivate the sound (from ON > OFF).
  - Sound Enable : User must press both lock and unlock buttons in the remote key or smart key together for at least 4seconds to activate Sound (from ON > OFF).
- For a successful Activation/Deactivation of Sound, Hazard warning flasher will blink 4 times.



## Door locks

### Operating door locks from outside the vehicle

#### Using the mechanical key



Turn the key toward the rear of the vehicle to unlock and toward the front of the vehicle to lock.

If you lock/unlock the driver's door with a key, all vehicle doors will lock/unlock automatically. (If equipped with the central door lock system)

Once the doors are unlocked, they may be opened by pulling the door handle.

When closing the door, push the door by hand. Make sure that doors are closed securely.

#### NOTICE

- When removing the key cylinder cover, avoid scratching or breaking the plastic material.
- If the key cylinder cover freezes and cannot be removed easily, lightly tap on the cover or try to warm the cover by placing your hands around it and blowing warm air on it.
- Do not apply excessive force to the door and door handle.

#### Using the remote key

For more information, refer to the "5-4" section in this chapter.

#### Using the smart key

For more information, refer to the "Smart key" section in this chapter.

#### *i* Information

- In cold and wet climates, door lock and door mechanisms may not work properly due to freezing conditions.
- If the door is locked/unlocked multiple times in rapid succession with either the vehicle key or door lock switch, the system may stop operating temporarily in order to protect the circuit and prevent damage to system components.

### Operating door unlocks from inside the vehicle

#### With the door inside handle



- To unlock a door, push the door lock button (1) to the "Unlock" position.
- To lock a door, push the door lock button (1) to the "Lock" position.
- To open a door, pull the door handle (2) outward.

- If the inner door handle of the driver's door is pulled when the door lock button is in the lock position, the button is unlocked and door opens.
- Front doors cannot be locked if the key is in the ignition switch and any front door is open.
- Doors cannot be locked if the smart key is in the vehicle and any door is open.

### **i** Information

If a power door lock ever fails to function while you are in the vehicle try one or more of the following techniques to exit:

- Operate the door unlock feature repeatedly (both electronic and manual) while simultaneously pulling on the door handle.
  - Operate the other door locks and handles, front and rear.
  - Lower a front window and use the mechanical key to unlock the door from outside.
- 

### **With the central door lock/unlock switch**

#### Driver's door



When pressing the  portion (1) on the switch, all vehicle doors are locked.

- If any door is opened, the doors are not locked even though the lock switch (1) of the door is pressed.

When pressing the  portion (2) on the switch, all vehicle doors are unlocked.

### **! WARNING**

- Always close and lock the doors whilst the vehicle is moving. If the doors are unlocked, the risk of being thrown from the vehicle in a collision increases.
  - Do not pull the inner door handle of the driver's or passenger's door whilst the vehicle is moving.
- 

### **! WARNING**

Do not leave the elderly, children, or animals unattended in your vehicle. An enclosed vehicle can become extremely hot and the elderly, unattended children or animals who cannot escape the vehicle may be seriously injured or killed.

---

**! WARNING**

Always park your vehicle properly. Depress the brake pedal, change the gear to P (Park), apply the parking brake, press the Engine Start/Stop button to the OFF position, close all windows, lock all doors, and always take the keys with you.

**! WARNING**

Be careful when opening doors and watch for vehicles, motorcycles, bicycles, or pedestrians approaching the vehicle to prevent serious injury or death.

**i Information**

To exit the vehicle if the power door lock does not function:

- Operate the door unlock feature repeatedly (both electronic and manual) whilst simultaneously pulling on the door handle.
- Operate the other door locks and handles.
- Lower the driver's front window and use the mechanical key to unlock the door from outside.

**Auto Door Lock/Unlock Features**

**+** if equipped

**Impact sensing door unlock system**

All doors are automatically unlocked when an impact causes the airbags to deploy.

**Child-protector rear door locks**

The child safety lock is provided to help prevent children seated in the rear from accidentally opening the rear doors.

The rear door safety locks must be used whenever children are in the vehicle.

The child safety lock is located on the edge of each rear door. When the child safety lock is in the lock position, the rear door does not open if the inner door handle is pulled.

To lock the child safety lock, insert a small flat blade tool (e.g. screwdriver or similar) into the slot and turn it to the lock position as shown.

To allow a rear door to be opened from inside the vehicle, unlock the child safety lock.

**! WARNING**

Never allow children to open the rear doors whilst the vehicle is moving. They may fall out of the vehicle. Make sure to use the rear door safety locks whenever children are in the vehicle.

## Theft-alarm system

This system helps to protect your vehicle and valuables. The horn sounds and the hazard warning lights blink continuously if any of the following occur:

- A door is opened without using the smart key.
- The tailgate is opened without using the smart key.
- The bonnet is opened.

The alarm continues for 30 seconds, then the system resets. To turn off the alarm, unlock the doors with the smart key.

The Theft Alarm System automatically sets 30 seconds after you lock the doors and the tailgate. For the system to activate, you must lock the doors and the tailgate from outside the vehicle by doing one of the following:

- Using the smart key.
- Pressing the button on the outside door handle with the smart key in your possession. (available with button type)
- Touching the touch sensor on the outside door handle with the smart key in your possession. (available with touch sensor type)

The hazard warning lights blink and the chime sounds once to indicate the system is armed.

Once the security system is set, opening any door, tailgate, or bonnet without using the smart key causes the alarm to activate.

The Theft Alarm System is not set if the bonnet, tailgate, or door is not fully closed. If the system is not set, check the bonnet, tailgate, or doors are fully closed.

Do not attempt to modify this system or add other devices to it.

### Disclaimer:

The system is designed in such a way that it makes vehicle theft difficult if its circuit and battery connection is uninterrupted.

### Information

- Do not lock the doors until all passengers have left the vehicle. If a door is opened after the system is armed, the alarm is activated.
  - If the vehicle is not disarmed with the smart key, open the doors using the mechanical key and start the engine by pressing the Engine Start/Stop button with the smart key.
  - If the system is disarmed by unlocking the vehicle, and a door or the tailgate is not opened within 30 seconds, the doors are relocked and the system is rearmed automatically.
-

## Steering wheel

### Motor Driven Power Steering (MDPS)

The system assists you with steering the vehicle. If the vehicle is turned off or if the power steering system becomes inoperative, you can still steer the vehicle, but it requires increased steering effort.

If you notice any change in the effort required to steer during normal vehicle operation, we recommend that you contact a HYUNDAI authorised repairer.

#### NOTICE

If the Motor Driven Power Steering  warning light and the message “**Check motor driven power steering**” illuminates on the instrument, you can continue to steer the vehicle, but it requires increased steering effort. We recommend that you contact a HYUNDAI authorised repairer and have the system inspected as soon as possible.

#### *i* Information

During normal vehicle operation:

- The steering effort may be high immediately after pressing the Engine Start/Stop button to the ON position.

This happens as the system performs the MDPS system diagnostics. When the diagnostics are completed, the steering wheel effort returns to its normal condition.

- When the battery voltage is low, you may have to use more effort to steer. This is a temporary condition and returns to normal condition after charging the battery.

- A click noise may be heard from the MDPS relay after the Engine Start/Stop button is in the ON or OFF position.
- Motor noise may be heard when the vehicle is at a stop or driving at low speeds.
- When you operate the steering wheel in low temperatures, abnormal noise may occur. When the temperature rises, the noise disappears.
- When an error is detected from MDPS, the steering effort assist function is not activated. Instrument cluster warning lights may illuminate or the steering effort may be high. If these symptoms occur, drive the vehicle to a safe location as soon as possible. We recommend that your vehicle be inspected by a HYUNDAI authorised repairer as soon as possible.

### Tilt/Telescopic steering

Adjust the steering wheel toward your chest, not toward your face. Make sure you can see the instrument cluster warning lights and gauges. After adjusting, push the steering wheel up and down to be in the locked position.

#### WARNING

Never adjust the steering wheel whilst driving. This may cause loss of vehicle control resulting in a collision.

#### NOTICE

Whilst adjusting the steering wheel height, please do not push or pull it hard since the fixture can be damaged.

### Manual adjustment



To adjust:

1. Pull down the lock-release lever (1).
2. Adjust the steering wheel to the desired angle (2).
3. Pull up the lock-release lever up to lock the steering wheel in place.

#### **i** Information

Sometimes the lock release lever may not engage completely. Pull down on the lock-release lever, readjust the steering wheel again, and then pull back up on the lock-release lever to lock the steering wheel in place.

### Horn



To sound the horn, press the area indicated by the horn symbol on your steering wheel (see illustration). The horn operates only when this area is pressed.

#### **NOTICE**

Do not strike the horn severely to or hit it with your fist. Do not press on the horn with a sharp-pointed object.

#### **NOTICE**

Do not clean the steering wheel surface with the following products:

- Organic solvents such as thinner, alcohol and petrol
- Chemical products such as leather cleaner, coating agent, and wax

## Mirrors

### Inside rearview mirror

Before driving your vehicle, check to see that your inside rearview mirror is properly positioned. Adjust the rearview mirror so that the view through the rear window is properly centred.

#### WARNING

Make sure your line of sight is not obstructed. Do not place objects in the rear seat, cargo area, or behind the rear head restraints that may interfere with your vision through the rear window.

#### WARNING

To prevent serious injury during a collision or deployment of the airbag, do not modify the rearview mirror and do not install a wide mirror.

#### WARNING

Never adjust the mirror whilst driving. This may cause loss of vehicle control and result in a collision.

#### NOTICE

When cleaning the mirror, use a paper towel or similar material dampened with glass cleaner. Do not spray glass cleaner directly on the mirror as this may cause the liquid cleaner to enter the mirror housing.

### Day/night rearview mirror

 if equipped



[A] Day  
[B] Night

Before driving at night, pull the day/night lever toward you to reduce glare from the headlights of the vehicles behind you.

Remember that you lose some rearview clarity in the night position.

### Electrochromic mirror

 if equipped

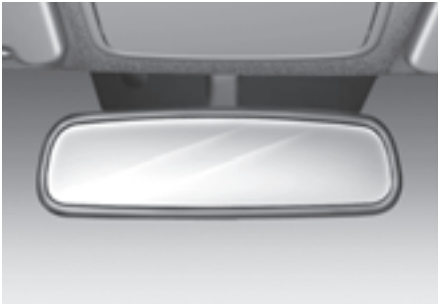

When the engine is running, the glare from vehicle headlights behind you is automatically controlled by the sensor mounted in the rearview mirror.

When the gear is shifted to R (Reverse), the mirror automatically goes to the brightest setting in order to improve the driver's view behind the vehicle.

### Outside rearview mirrors



Your vehicle is equipped with both left-hand and right-hand outside rearview mirrors. The mirrors can be adjusted with the mirror adjustment control switch. Adjust the side view mirrors to your desired position before driving. The outside rearview mirrors can be folded to help prevent damage when going through an automatic car wash or when passing through a narrow street.

#### **WARNING**

The left and right outside rearview mirrors are convex. Objects seen in the mirror are closer than they appear.

Use the rearview mirror or turn your head and look to determine the actual distance of other vehicles prior to changing lanes.



**⚠ WARNING**

Do not adjust or fold the outside rearview mirrors whilst driving. This may cause loss of vehicle control resulting in a collision.

**NOTICE**

- Do not scrape ice off the mirror face. This may damage the surface of the glass.
- If the mirror is jammed with ice, do not adjust the mirror by force. Use an approved de-icer (not radiator antifreeze) spray, or a sponge or soft cloth with very warm water, or move the vehicle to a warm place and allow the ice to melt.
- Do not clean the mirror with harsh abrasives, fuel, or other petroleum based cleaning products.

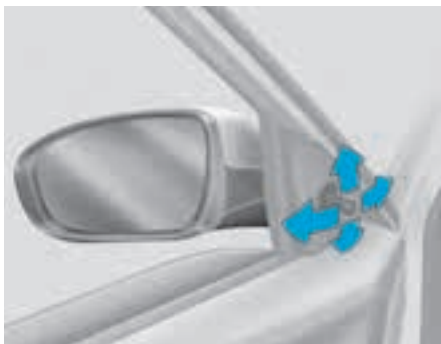
***Adjusting the outside rearview mirrors*****Manual type (if equipped)**

To adjust an outside mirror, move the control lever.

**Electric type (if equipped)**

1. Press the switch (1) to the L (left side) or R (right side) to select the outside rearview mirror you want to adjust.
2. Use the mirror adjustment control switch (2) to position the selected mirror up, down, left, or right.
3. After adjustment, press the switch (1) to the middle to prevent unintended adjustment.

**NOTICE**

- The mirrors stop moving when they reach the maximum adjusting angles, but the motor continues to operate whilst the switch is pressed. Do not press the switch longer than necessary, because this can damage the motor.
- Do not adjust the outside rearview mirrors by force to prevent damage to the motor.

### Folding the outside rearview mirrors

 if equipped

#### Manual type (if equipped)

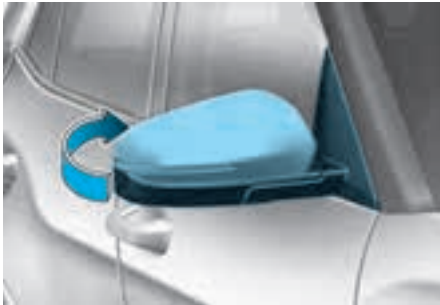

To fold the outside rearview mirror, grasp the housing of the mirror and then fold it toward the rear of the vehicle.

#### Folding button (if equipped)



The outside rearview mirrors can be folded or unfolded by pressing the button.

#### Infotainment system setting (if equipped)

- Enable on door unlock  
If **Settings > Vehicle > Lights > Welcome mirror/light > On door unlock** is selected from the Settings menu in the infotainment system:
  - The mirror folds or unfolds when the door is locked or unlocked using the smart key.
  - The mirror folds or unfolds when the door is locked or unlocked by the touching the touch sensor on the outside door handle.
- Enable on driver approach  
If **Settings > Vehicle > Lights > Welcome mirror/light > On driver approach** is selected from the Settings menu in the infotainment system, the mirror unfolds when the vehicle is approached with the smart key in possession.

#### Information

- The infotainment system may change after software updates. For more information, refer to the manual provided in the infotainment system and the quick reference guide.
- For your safety, the outside rearview mirrors cannot be folded automatically when driving at a speed of 15 km/h (9 mph) or faster.

#### NOTICE

To prevent unnecessary battery discharge, do not adjust the mirrors longer than necessary when the engine is not running.

#### NOTICE

Do not fold the electric type outside rearview mirror by hand. It may cause motor failure.

## Reverse parking aid

 if equipped



When the gear is shifted to the R (Reverse) position, the outside rearview mirrors will rotate downwards to aid with driving in reverse.

The state of the outside rearview mirror switch (1) determines whether or not the mirrors move.

### How it works

- **Left/Right** : When the switch is pressed to L or R, both outside rearview mirrors move.
- **Neutral** : When both L or R is not pressed, the outside rearview mirrors does not move.

The outside rearview mirrors automatically revert to their original positions if any of the following occur:

- The Engine Start/Stop button is pressed to either the OFF position or the ACC position.
- The gear is shifted to any position except R (Reverse).
- The outside rearview mirror adjustment button is not selected.

### Reverse parking aid user settings mode

You may change the angle of the outside rearview mirror if it is difficult to see the rear view with the basic downward mirror angle provided when reversing.

When the vehicle is first delivered, the set downward angle of the left and right outside rearview mirror are different to ensure driver visibility.

1. Make sure the vehicle is stopped.
2. Depress the brake pedal and shift the gear to R (Reverse). When L or R switch is pressed, both outside rearview mirrors move downward to the basic set position.
3. Press the L or R switch to select the outside rearview mirror you want to adjust. Then press “▼, ▲, ◀, ▶” switch to adjust the outside rearview mirror to the desired angle.
4. After adjusting the angle to save the adjusted outside rearview mirror angle, shift the gear to another position other than R (Reverse), or change the L and R switch to the neutral position (L and R switch is not pressed).
5. Set the other outside rearview mirror following the above procedure 1 to 4.

### Resetting reverse parking aid user settings mode

To change the outside rearview mirror angle back to the basic angle, shift the gear to R (Reverse), and adjust the mirror angle higher than when the gear is in P (Park), N (Neutral) and D (Drive).

### NOTICE

When changing the angle of both outside rearview mirrors, it is recommended to change the angle one side at a time following the procedure 1 to 4.

## Windows

Front / Rear

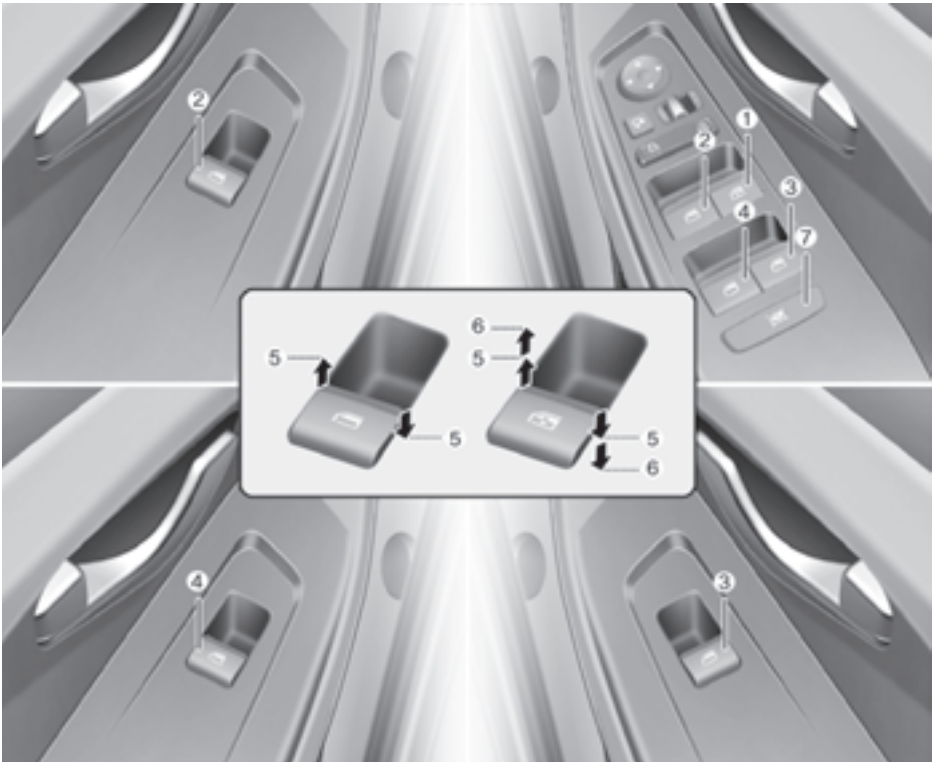

- (1) Driver's door power window switch
- (2) Front passenger's door power window switch
- (3) Rear door (right) power window switch
- (4) Rear door (left) power window switch
- (5) Window opening and closing
- (6) Automatic power window
- (7) Power window lock switch

## Power windows

**+** if equipped

The ignition switch must be in the ON position to be able to raise or lower the windows. Each door has a power window switch to control the door's window. The driver has a Power Window Lock button that can block the operation of rear passenger windows. The power windows operate for about 3 minutes after the Engine Start/Stop button is in the ACC or OFF position. If the front doors are opened, the battery power is turned OFF and the Power Windows do not operate.

### Window opening and closing



To open:

Press the window switch down to the first detent position (5). Release the switch when you want the window to stop.

To close:

Pull the window switch up to the first detent position (5). Release the window switch when you want the window to stop.

### Auto up/down window (for driver's window)

**+** if equipped

Pressing the power window switch momentarily to the second detent position (6) completely lowers or lifts the window even when the switch is released. To stop the window at the desired position whilst the window is operating, pull up or press down and release the switch.

#### **!** WARNING

- Do not leave the vehicle running and the key in your vehicle with unsupervised children. Unattended children could operate the window, which could result in serious injury.
- Do not extend your head, arms or any other body parts or objects outside the window whilst driving to avoid serious injury.

### Resetting the power windows

If the power windows do not operate normally, the automatic power window system must be reset as follows:

1. Place the ignition switch to the ON position.
2. Close the window and continue pulling up on the power window switch for at least one second.

If the power windows do not operate properly after resetting, we recommend that you contact a HYUNDAI authorised repairer.

#### **!** WARNING

Make sure body parts or other objects are out of the way before closing the windows. The automatic reverse feature does not operate whilst resetting the power window system.

### Automatic reversal

 if equipped

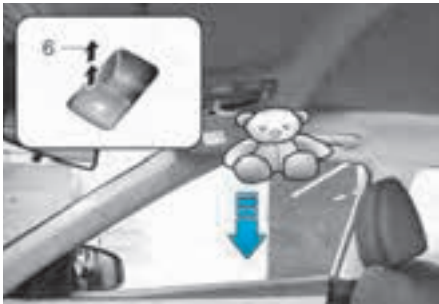

If a window senses any obstacle whilst it is closing automatically, it stops and lowers about 12 inches (30 cm) to allow the object to be cleared.

If the window detects any resistance whilst the power window switch is pulled up continuously, the window stops upward movement and then lowers about 1 inch (2.5 cm).

If the power window switch is pulled up continuously again within 5 seconds after the window is lowered by the automatic window reverse feature, the automatic window reverse does not operate.

#### Information

The automatic reverse feature is active only when the “Auto Up” feature is used by fully pulling up the switch to the second detent.

### NOTICE

Do not install any accessories on the windows. The automatic reverse feature may not operate.

### WARNING

Make sure body parts or other objects are safely out of the way before closing the windows to avoid injuries or vehicle damage.

Objects less than 0.16 inches (4 mm) in diameter caught between the window glass and the upper window channel may not be detected by the automatic reverse window and the window does not stop and reverse direction.

### Power window lock button

 if equipped



The driver can disable the power window switches on the rear passenger doors by pressing the power window lock button. When the power window lock button is pressed:

- The driver’s master control can operate all the power windows.
- The front passenger’s control can operate the front passenger’s power window.

- The rear passenger's control cannot operate the rear passengers' power window.

### WARNING

Do not allow children to play with the power windows. Keep the driver's door power window lock button in the LOCK position. Serious injury or death may result from unintentional window operation by a child.

### NOTICE

- To prevent possible damage to the power window system, do not open or close two windows or more at the same time. This also ensures the longevity of the fuse.
- Never try to operate the main switch on the driver's door and the individual door window switch in opposite directions at the same time. If this is done, the window stops and cannot be opened or closed.

## Panorama sunroof

 if equipped

If your vehicle is equipped with a sunroof, you can slide or tilt your sunroof with the sunroof switch located on the overhead console.



The sunroof can only be operated when the ignition switch or engine Start/Stop button is in the ON or START position.

The sunroof can be operated for about 10 minutes after the ignition switch or engine Start/Stop button is in the ACC or OFF position. However, if the front door is open, the sunroof cannot be operated even within the 10 minute period.

### WARNING

- Adjust the sunroof or sunshade when your vehicle stops. This could result in loss of control and an accident that may cause injury, or property damage.
- Do not leave the engine running and the key in your vehicle with unsupervised children. Unattended children could operate the sunroof, which could result in serious injury.
- Do not sit on the top of the vehicle. It may cause injury or vehicle damage.

**NOTICE**

Do not operate the sunroof when roof bars are installed on the vehicle or when there is luggage on the roof.

**Power sunshade**



Use the sunshade to block direct sunlight coming through the sunroof glass.

- Push the sunroof switch rearward to the first detent position, the power sunshade automatically slides open.
- Push the sunroof switch forward to the first detent position, the power sunshade automatically closes. However, if the sunroof glass is open, the glass will close first.

To stop the power sunshade at any point, push the sunroof switch in any direction.

**NOTICE**

Do not pull or push the power sunshade by hand as such action may damage the power sunshade or cause it to malfunction.

**i Information**

Wrinkles formed on the power sunshade are normal due to material characteristic.

**Tilt open/close**



- Push the sunroof switch upward, the sunroof glass tilts open. However, if the power sunshade is closed, the sunshade will open first.
- Push the sunroof switch upward or forward when the sunroof glass is tilt opened, the sunroof glass automatically closes.

To stop the sunroof movement at any point, push the sunroof switch in any direction.

**Slide open/close**



- Push the sunroof switch rearward to the first detent position, the sunroof glass opens. However, if the power sunshade is closed, the power sunshade will open first.



Push the sunroof switch forward to the first detent position, the sunroof glass closes. However, if the sunroof glass is closed, the power sunshade will close.

- Push the sunroof switch forward or rearward to the second detent position, the power sunshade and sunroof glass operate automatically (auto slide feature). To stop the sunroof movement at any point, push the sunroof switch in any direction.

## Automatic reversal

 if equipped



If the power sunshade or sunroof glass senses any obstacle whilst it is closing automatically, it will reverse direction then stop at a certain position.

The auto reverse function may not work if an object thin or soft is caught between the sliding sunroof glass and sunroof sash.

### WARNING

- Make sure heads, hands, arms or any other body parts or objects are out of the way before operating the sunroof. Body parts or objects may get caught causing injuries or vehicle damage.
- Never deliberately use your body parts to test the automatic reversal function. The sunroof glass may reverse direction, but there is a risk of injury.

### NOTICE

- Do not continue to push the sunroof switch after the sunroof is fully opened, closed, or tilted. Damage to the sunroof motor could occur.
- Continuous operations such as slide open/close, tilt open/close, etc. may cause the motor or sunroof system to malfunction.
- Regularly remove any accumulated dust on the sunroof rail.
- Dust accumulated between the sunroof and roof panel can make noise. Open the sunroof and remove dust regularly using a clean cloth.
- Do not try to open the sunroof when the temperature is below freezing or when the sunroof is covered with snow or ice. The sunroof may not work properly and may break if opened by force.
- Do not open or drive with the sunroof glass open immediately after rain or washing the vehicle. Water may wet the interior of the vehicle.
- Do not extend any luggage outside the sunroof whilst driving. Vehicle damage may occur if the vehicle suddenly stops.

### WARNING

Do not extend your head, arms, body parts or objects outside the sunroof whilst driving. Injuries may occur if the vehicle suddenly stops.

## Resetting the sunroof



In some circumstances resetting the sunroof operation may need to be performed. Some instances where resetting the sunroof may be required include:

- When the 12-volt battery is either disconnected or discharged
- When the sunroof fuse is replaced
- If the sunroof one-touch AUTO OPEN/CLOSE operation is not functioning properly

Sunroof resetting procedure:

1. It is recommended to perform the reset procedure with the vehicle engine running. Start the vehicle in P (Park).
2. Make sure the sunroof glass is in the fully closed position. If the sunroof glass is open, push the switch forward until the sunroof glass is fully closed.
3. Release the switch when the sunroof glass is fully closed.
4. Push the switch forward until the sunroof glass moves slightly. Then release the switch.
5. Once again push and hold the sunroof switch forward until the sunroof glass slides open and close. Do not release the switch until the operation is completed.

If you release the switch during operation, start the procedure again from step 2.

## *i* Information

If the sunroof does not reset when the vehicle battery is disconnected or discharged, or the sunroof fuse is blown, the sunroof may not operate normally.

## Sunroof open warning

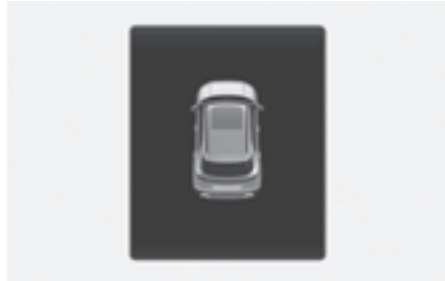

If the driver turns off the engine when the sunroof is not fully closed, the warning chime will sound for several seconds and the sunroof open warning will appear on the cluster display.

Close the sunroof securely when leaving your vehicle.

## CAUTION

Make sure the sunroof is closed fully when leaving your vehicle.

If the sunroof is left open, rain or snow may wet the interior of the vehicle. Also, leaving the sunroof open when the vehicle is unattended may invite theft.

## Bonnet

### Opening the bonnet



1. Park the vehicle and apply the parking brake.
2. Pull the bonnet release lever to unlatch the bonnet. The bonnet pops open slightly.

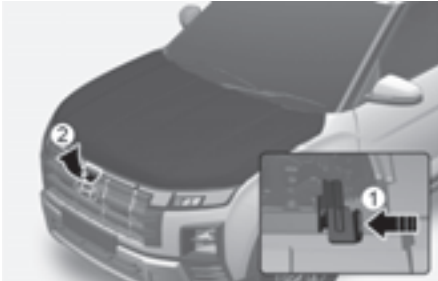

3. Go to the front of the vehicle, raise the bonnet slightly, push up the secondary bonnet release lever (1) inside of the bonnet centre and lift the bonnet (2).



4. Pull out the support rod.
5. Hold the hood opened with the support rod.

### **WARNING**

The support rod must be inserted completely into the hole provided whenever you inspect the engine compartment. This will prevent the hood from falling and possibly injuring you.

## Closing the bonnet

1. Before closing the bonnet, check in and around the engine compartment to ensure the following:
  - Any tools or other loose objects have been removed.
  - All gloves, rags, or other combustible material have been removed.
  - All filler caps are tightly and correctly installed.
2. Return the support rod to its clip to prevent it from rattling.
3. Lower the bonnet until it is about 12 inches (30 cm) above the closed position and then let it drop.
4. Check the bonnet has locked properly. If the bonnet is raised slightly, open it again and drop it from a little higher. Check again.

### **WARNING**

- Before closing the bonnet, ensure all obstructions are removed from around the bonnet opening.
  - Always double check to make sure that the bonnet is firmly latched before driving away. Check there is no bonnet open warning light or message displayed on the instrument cluster. Driving with the bonnet open may cause a total loss of visibility, resulting in a collision.
  - Do not move the vehicle with the bonnet raised. It may block your vision and may result in a collision.
- 

## Tailgate

### Opening the tailgate

#### *Opening from outside*



Make sure the shift lever is in P (Park, for Intelligent variable transmission/Automatic transmission/Dual clutch transmission vehicle) position or first gear or R (Reverse, for Manual transmission) position and set the parking brake.

To open do one of the following:

- Unlock all doors with the door unlock button on your remote key or smart key. Press the tailgate handle switch and open the tailgate.
- Press and hold the tailgate unlock button on the remote key or smart key. Press the tailgate handle switch and open the tailgate.

## Closing the tailgate



Lower the tailgate lid and press down until it locks. Always check it is secure by pulling on the handle.

### WARNING

Always keep the tailgate completely closed whilst the vehicle is moving. If it is left open or ajar, poisonous exhaust gases containing carbon monoxide (CO) may enter the vehicle and serious injury or death may result.

### WARNING



Always close the tailgate before driving. Do not grab or hold on to the tailgate support struts or they may be damaged. Deformation of the tailgate support struts may result in vehicle damage and personal injury.

### WARNING

Never allow anyone to occupy the cargo area of the vehicle at any time. If the tailgate is partially or totally latched and the person cannot get out, serious injury or death may occur due to lack of ventilation, exhaust fumes, and rapid heat build-up, or due to exposure to cold weather conditions. The cargo area is also a very dangerous location in the event of a collision because it is part of the vehicle's crush zone.

## Emergency tailgate safety release



To unlock and open the tailgate manually from inside the cargo area, perform the following:

1. Insert a long, flat object, such as a key into the opening at the bottom of the tailgate.
2. Slide the latch in the direction of the arrow to unlock the tailgate.
3. Push the tailgate open.

### WARNING

- Never allow anyone to occupy the cargo area of the vehicle at any time. The cargo area is a very dangerous location in the event of a collision because it is part of the vehicle's crush zone.
- Use the release lever for emergencies only.

## Fuel filler door

### Opening the fuel filler door

1. Turn the engine off.
2. Pull up the fuel filler door opener.



3. Pull the fuel filler door (1) outward to access the fuel tank cap.
4. To remove the fuel tank cap (2), turn it counterclockwise. You may hear a hissing noise as the pressure inside the tank equalizes.

Petrol



Diesel



5. Place the cap on the fuel filler door (3).

### WARNING

- Your diesel vehicle is equipped with the specially-designed breakaway valve inside the filler inlet to prevent accidental fuel blending with petrol. The fuel inlet of your diesel vehicle cannot be fitted with a standard petrol nozzle. Do not forcefully insert a standard petrol nozzle into the filler inlet of your diesel vehicle. It may damage your vehicle.
- Some gas stations may still use standard petrol nozzles for diesel refueling. If you find that a diesel nozzle is narrower than the fuel filler inlet diameter of your diesel vehicle, we recommend you to find/visit another gas station, which is equipped with standard diesel nozzles.
- Fully insert a standard diesel nozzle into the filler inlet to open the breakaway valve. If the nozzle is not fully inserted into the filler inlet, it causes diesel fuels to flow out of the fuel tank.

## **i** Information

If the fuel filler door does not open because ice has formed around it, tap lightly or push on the door to break the ice and release the door. Do not open the door. If necessary, spray around the door with an approved deicer fluid (do not use radiator antifreeze) or move the vehicle to a warm place and allow the ice to melt.

## Closing the fuel filler door

1. To install the fuel tank cap, turn it clockwise until it “clicks” one time.
2. Close the fuel filler door until it is latched securely.

## WARNING

Automotive fuel is highly flammable and explosive. Failure to follow these guidelines may result in **SERIOUS INJURY** or **DEATH**:

- Read and follow all warnings posted at the gas station.
- Before refuelling, note the location of the Emergency Fuel Shut-Off, if available, at the gas station.
- Before touching the fuel nozzle, you should eliminate the potential build-up of static electricity by touching a metal part of the vehicle, a safe distance away from the fuel filler neck, nozzle, or other gas source, with your bare hand.
- Do not use mobile phones whilst refuelling. Electric current and/or electronic interference from mobile phones can potentially ignite fuel vapours and cause a fire.
- Do not get back into a vehicle once you have begun refuelling. You can generate a buildup of static electricity by touching, rubbing or sliding against any item or fabric capable of producing static electricity. Static electricity discharge can ignite fuel vapours causing a fire. If you must re-enter the vehicle, you should once again eliminate potentially dangerous static electricity discharge by touching a metal part of the vehicle, away from the fuel filler neck, nozzle or other fuel source, with your bare hand.
- When using an approved portable fuel container, be sure to place the container on the ground prior to refuelling. Static electricity discharge from the container can ignite fuel vapours causing a fire.

Once refuelling has begun, contact between your bare hand and the vehicle should be maintained until the filling is complete.

- Use only approved portable plastic fuel containers designed to carry and store fuel.
- When refuelling, always shift the gear to the P (Park) position (for Dual clutch transmission, Intelligent variable transmission and Automatic transmission) or 1st gear or R (Reverse) (for Manual transmission), apply the parking brake, and place the Engine Start/Stop button to the OFF position. Sparks produced by electrical components related to the engine can ignite fuel vapours causing a fire.

- Do not use matches or a lighter and do not smoke or leave a lit cigarette in your vehicle whilst at a gas station, especially during refuelling.
- Do not over-fill or top-off your vehicle tank, which can cause fuel spillage.
- If a fire breaks out during refuelling, leave the vicinity of the vehicle, and immediately contact the manager of the gas station and then contact the local fire department. Follow any safety instructions they provide.
- If pressurized fuel sprays out, it can cover your clothes or skin and thus subject you to the risk of fire and burns. Always remove the fuel cap carefully and slowly. If the cap is venting fuel or if you hear a hissing sound, wait until the condition stops before completely removing the cap.
- Always check that the fuel cap is installed securely to prevent fuel spillage in the event of an accident.

### **NOTICE**

- Do not spill fuel on the exterior surfaces. It may damage the paint.
  - If the fuel filler cap needs to be replaced, we recommend that you use only a genuine HYUNDAI cap or the equivalent or the fuel system or emission control system may malfunction.
- 

## Exterior lights

### Lighting control

To operate the lights, turn the knob at the end of the control lever to one of the following positions:



- (1) OFF
- (2) AUTO light (if equipped)
- (3) Position light
- (4) Headlight



## AUTO headlight

**+** if equipped

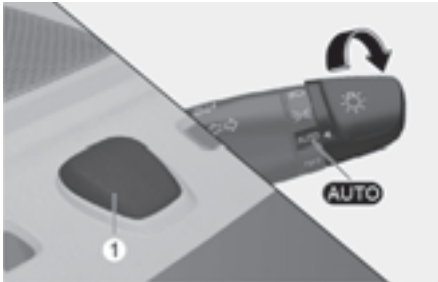

The position light and headlight are turned ON or OFF automatically depending on the amount of daylight as measured by the ambient light sensor (1) in front of the instrument panel.

Even with the AUTO headlight feature in operation, it is recommended to manually turn ON the headlights when driving at night or in a fog, driving in the rain, or when you enter dark areas, such as tunnels and parking facilities.

### NOTICE

- Do not cover or spill anything on the sensor (1) located in front of the instrument panel.
- Do not clean the sensor using a window cleaner, the cleanser may leave a light film which could interfere with sensor operation.
- If your vehicle has window tint or other types of metallic coating on the front windscreen, the AUTO headlight system may not work properly.

## Position light (☞)



The position light, license plate light, and instrument panel lamp are turned ON.

## Headlight (☞)



The headlight, position light, license plate light and instrument panel lamp are turned ON.

### *i* Information

The ignition switch or Engine Start/Stop button must be in the ON position to turn on the headlight.

## High beam operation



To turn on the high beam headlight, push the lever away from you. The lever returns to its original position.

The high beam indicator illuminates when the headlight high beams are switched on.

To turn off the high beam headlight, pull the lever towards you. The low beams turn on.

### **WARNING**

Do not use high beam when there are other vehicles approaching you. Using high beam could obstruct the other driver's vision.



To flash the high beam headlight, pull the lever towards you, then release the lever. The high beams remain ON as long as you hold the lever.

## Turn signals and lane change signals

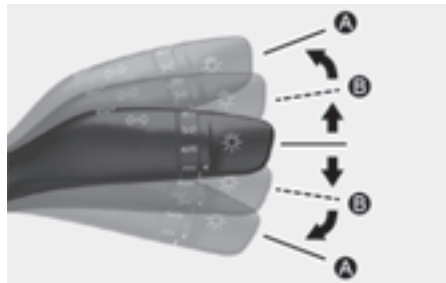

To signal a turn, push down on the lever for a right turn or up for a left turn in position (A).

If an indicator stays on and does not flash or if it flashes abnormally, one of the turn signal bulbs may be burned out and may require replacement. We recommend that you contact a HYUNDAI authorised repairer.

### **One touch turn signal**

To use One Touch Turn Signal, push the turn signal lever up or down to position (B) and then release it.

The lane change signals blink 3, 5, or 7 times.

You can enable the One Touch Turn Signal function or choose the number of blinking by selecting **Settings > Vehicle > Lights > One touch turn indicator > 7 flashes/5 flashes/3 flashes/Off** in the infotainment system.

## Battery saver function

To prevent the battery from being discharged, the system automatically turns off the position light when the driver turns the vehicle off and opens the driver's door.

With this feature, the position lights turn off automatically if the driver parks on the side of road at night.

To keep the lights on when the vehicle is turned off:

1. Open the driver's door.
2. Turn the position lights OFF and ON again using the headlight switch.

## Headlight escort function

If you place the ignition switch or engine Start/Stop button to the ACC or LOCK position with the headlights (Low) ON, the headlights remain on for about 5 minutes.

However, if the driver's door is opened and closed, the headlights are turned off after 15 seconds.

The headlights can be turned off by pressing the lock button on the transmitter twice or turning the light switch to the OFF position.

For deactivation or activation of this feature, contact an authorised HYUNDAI dealer.

## Headlight levelling device



To adjust the headlight beam level according to the number of the passengers and loading weight in the luggage area, turn the beam levelling switch.

The higher the number on the switch position, the lower the headlight beam level. Always keep the headlight beam at the proper levelling position, or headlights may dazzle other road users.

Listed below are examples of appropriate switch settings for varying loads. For loading conditions other than those listed, adjust the switch position to the most similar situation.

Loading condition	Switch position
Driver only	0
Driver + Front passenger	0
Full passengers (including driver)	1
Full passengers (including driver) + Maximum permissible loading	2
Driver + Maximum permissible loading	3

### **WARNING**

If the function does not work properly, we recommend that the system be inspected by a HYUNDAI authorised repairer. Do not attempt to inspect or replace the wiring yourself.

---

### Headlight time-out function

 If equipped

If the Engine Start/Stop button is in the ACC or OFF position with the headlights ON, the headlights (and/or position lights) remain on for about 5 minutes.

If the driver's door is opened and closed, the headlights are turned off after 15 seconds. Also, with the vehicle off if the driver's door is opened and closed, the headlights (and/or position lights) are turned off after 15 seconds.

The headlights (and/or position lights) can be turned off by pressing the lock button on the smart key twice or turning the headlight switch to the OFF or AUTO position.

You can enable the headlight time-out function by selecting **Settings > Vehicle > Lights > Headlight time-out** in the infotainment system.

### **Information**

If the driver exits the vehicle through another door besides the driver's door, the battery saver function does not operate and the headlight time-out function does not turn OFF automatically.

To avoid battery discharge, turn OFF the headlights manually from the headlight switch before exiting the vehicle.

---

### **Information**

The infotainment system may change after software updates. For more information, refer to the manual provided in the infotainment system and the quick reference guide.

---

### Interior button lights

 If equipped

The interior button lights turns on or off in the following conditions:

- The interior button lights turn on for a whilst when the door is unlocked and opened after all doors were closed and locked.
- The interior button lights always turns on when the vehicle is turned on.
- The interior button lights turn on for a whilst when the vehicle is turned off. If the door is opened and closed or locked, the interior button lights turn off immediately.

You can enable the interior button lights by selecting **Settings > Vehicle > Lights > Always On Interior Button Lights** in the infotainment system.

### **Information**

The infotainment system may change after software updates. For more information, refer to the manual provided in the infotainment system and the quick reference guide.

---

## Daytime Running Light (DRL)

 if equipped

The Daytime Running Lights (DRL) can make it easier for others to see the front of your vehicle during the day, especially after dawn and before sunset.

The DRL system turns OFF when:

- The headlights are on.
- The parking brake is applied.
- The engine is off.
- The automatic transmission control is in park position (if equipped)

## Welcome system

 if equipped

Welcome system helps keep the driver visible by turning on vehicle lights when the driver approaches the vehicle.

### Door handle light

When all the doors (and tailgate) are closed and locked, the door handle light will turn on for about 15 seconds if:

- **Settings > Vehicle > Convenience > Welcome mirror/light > On door unlock** is selected in the infotainment system,
  - The door lock button is pressed on the smart key.
  - The button of the outside door handle is pressed whilst carrying the smart key.
  - You put your hand in the outside door handle whilst carrying the smart key.
- The smart key is detected, and both **Convenience > Welcome mirror/light > On door unlock** and **Convenience > Welcome mirror/light > On driver approach** are selected.

You can activate or deactivate the Welcome Light function from the Settings menu in the infotainment system.

## Information

The infotainment system may change after software updates. For more information, refer to the manual provided in the infotainment system and the quick reference guide.

### Headlight and position light

When the headlight switch is in the headlight or AUTO position and all the doors (and tailgate) are closed and locked, the position lights and headlights come on for about 15 seconds when the door unlock button is pressed on the smart key.

If you press the door lock or unlock button, the position lights and headlights turn off immediately.

Select **Settings > Vehicle > Lights > Headlight time-out** from the infotainment system to turn on this function.

### Interior light

When the interior light switch is in the  position and all doors (and tailgate) are closed and locked, the room lamps come on for 30 seconds when:

- The door unlock button is pressed on the smart key.
- The button of the outside door handle is pressed whilst carrying the smart key.
- You put your hand in the outside door handle whilst carrying the smart key.

If you press the door lock or unlock button on the smart key, the lights turn off immediately.

## High Beam Assist (HBA)

 If equipped



High Beam Assist automatically switches between high beam and low beam depending on the detected brightness from the lights of oncoming vehicles or vehicles in front.

### Detecting sensor



[A] Front view camera

The front view camera is used as a detecting sensor to detect ambient light and brightness whilst driving.

Refer to the picture above for the detailed location of the detecting sensor.

### NOTICE

- Always keep the front view camera in good condition to maintain optimal performance of High Beam Assist.
- For more information on the limitations of the front view camera, refer to the “Forward Collision-Avoidance Assist (FCA) (Sensor fusion)” section in chapter 7.

### High Beam Assist settings

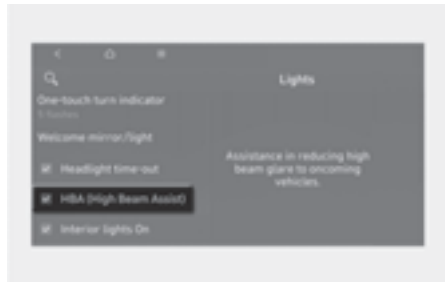

With the Engine Start/Stop button in the ON position, select **Settings > Vehicle > Lights > HBA (High Beam Assist)** from the Settings menu to turn on High Beam Assist and deselect to turn off the function.

### WARNING

Only change the settings after parking your vehicle at a safe location.

## High Beam Assist operation

- After selecting **High Beam Assist** from the Settings menu to operate High Beam Assist:
  - Place the headlight switch in the AUTO position and push the headlight lever towards the instrument cluster. The High Beam Assist (HBA) indicator light illuminates.
  - When High Beam Assist is enabled, high beams turn on when the vehicle speed is above 30 km/h (20 mph) and the High Beam (HBA) indicator illuminates. When the vehicle speed is below 20 km/h (12 mph), high beams do not turn on and the indicator light illuminates in white.
- When High Beam Assist is operating:
  - If the turn signal lever is pulled toward you when the high beams are off, the high beams turn on. When you let go of the turn signal lever, High Beam Assist operates again.
  - If the turn signal lever is pulled toward you when the high beams are on by High Beam Assist, the low beams turn on and High Beam Assist turns off.
  - If the turn signal lever is pushed away from you, the high beams turn on and High Beam Assist turns off.
  - If the headlight switch is moved from AUTO to another position (headlight/position/off), the corresponding light turns on and High Beam Assist turns off.
- When High Beam Assist is operating, high beam may switches automatically to low beam if:
  - The headlights of an oncoming vehicle are detected.
  - The tail lights of a front vehicle are detected.
  - The headlight or tail light of a motorcycle or a bicycle is detected.
  - The surrounding ambient light is bright enough so high beams are not required.
  - Streetlights or other lights are detected.

### *i* Information

The images and colours in the cluster may differ depending on the cluster type or theme selected from the cluster.

## High Beam Assist malfunction and limitations

### *High Beam Assist malfunction*



When High Beam Assist is not working properly, the “**Check High Beam Assist system**” warning message may appear, and the  warning light may illuminate on the instrument cluster. We recommend that the system be inspected by a HYUNDAI authorised repairer.

### **Limitations of High Beam Assist**

High Beam Assist may not work properly in the following situations if:

- The headlights from an oncoming or front vehicle is damaged or out of the detection range.
- The headlights from an oncoming or front vehicle are covered with dust, snow, or water.
- An oncoming or front vehicle's headlights are off but the fog lights are on.
- There are lights that have a similar shape as a vehicle's light ahead.
- The headlights are not repaired or replaced properly.
- The headlights are not aimed properly.
- You are driving on a narrow curved road, rough road, uphill, or downhill.
- A front vehicle is partially visible at a crossroad or on a curved road.
- There is a temporary reflector or flash ahead (construction area).
- There is a traffic light, reflecting sign, LED sign, or reflectors ahead.
- The road is wet or covered with snow or ice.
- A vehicle suddenly appears from a curve.
- The vehicle is tilted due to a flat tyre or being towed.
- The headlights from an oncoming or front vehicle is not detected because of exhaust fumes, smoke, fog, snow, blizzard, water spray on the road, or windscreen condensation, etc.

### ***i* Information**

For more information on the limitations of the front view camera, refer to the "Forward Collision-Avoidance Assist (FCA) (Sensor fusion)" section in chapter 7.

---

### **WARNING**

- Always check road conditions, and if necessary, take appropriate actions to drive safely. It is your responsibility to operate your vehicle in a safe manner.
  - If High Beam Assist does not operate properly, use the turn signal lever to switch between high beam and low beam.
  - High Beam Assist may not operate for 15 seconds right after your vehicle is started or when the front view camera is initialized.
-



## Interior lights

### WARNING

Do not use the interior lights when driving in the dark. The interior lights may obscure your view and result in a collision.

Do not use the interior lights for extended periods when the vehicle is turned off. Otherwise, the battery discharges.

### Interior lamp AUTO off

The interior lights automatically go off about 20 minutes after the vehicle is turned off and the doors are closed. If a door is opened, the light go off 25 minutes after the vehicle is turned off. If the doors are locked by the smart key and the vehicle enters the armed stage of the theft alarm system, the lights go off 5 seconds later.

## Front lights

Type A



Type B



Type C





- (1) Front map lamp
- (2) Front room lamp
- (3) Front door lamp

### Front map lamp

Press the map lamp lens (1) to turn on the map lamp. Re-press the map lamp cover to turn off the map lamp.

### Front room lamp

- :  
(Type A) Press the button to turn on the room lamp for the front and rear seats.  
(Type B) Press the button to turn on the room lamp for the front and rear seats. Press again the button to turn off the room lamp.
- :  
(Type A) Press the button to turn off the room lamp for the front and rear seats.

### Front door lamp()

The room lamp for the front and rear seats is automatically turned on for approximately 30 seconds, when a door is opened.

The room lamp for the front and rear seats is automatically turned on for approximately 15 seconds, when the remote key or smart key unlocks the doors. The room lamp fades out, when the ignition switch or engine Start/Stop button is in the ON position in 15 seconds. The room lamp remains on up to 20 minutes, when a door is opened with the ignition switch or engine Start/Stop button in the either the ACC or OFF position.

## Rear lamps

Room lamp



Personal lamp (if equipped)



: Press the button to turn on and off the rear room lamp.

## Cargo area lamp



The cargo area lamp turns on when the tailgate is opened and off when the tailgate is closed.

### NOTICE

Close the tailgate after use to prevent unnecessary battery discharge.

## Wipers and washers

Front windscreen wiper/washer

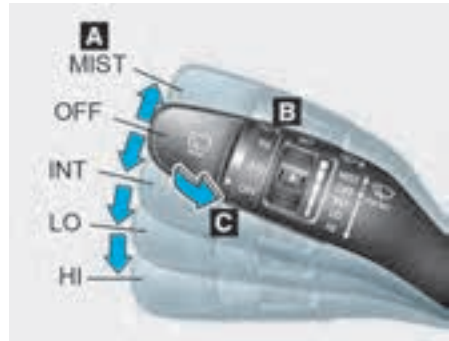

Rear windscreen wiper/washer

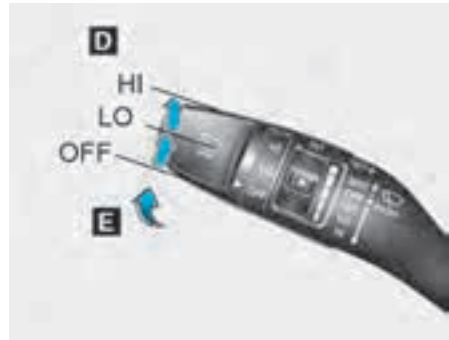

### A. Wiper speed control

- **MIST**: Single wipe
- **OFF**: Off
- **INT**: Intermittent wipe.
- **LO**: Low wiper speed.
- **HI**: High wiper speed.

### B. Intermittent or Auto control wipe time adjustment

### C. Wash with brief wipes (front)

### D. Rear wiper control

- **HI**: High wiper speed.
- **LO**: Low wiper speed.
- **OFF**: Off

### E. Wash with brief wipes (rear)

### Front windscreen wipers

Operates as follows when the engine is turned on.

- **MIST:** For a single wiping cycle, push the lever downward and release. The wipers operate continuously if the lever is held in this position.
- **OFF:** Wipers are not in operation.
- **INT:** Wiper operates intermittently at the same wiping intervals. To vary the speed setting, turn the speed control knob.
- **LO:** The wiper runs at a lower speed.
- **HI:** The wiper runs at a higher speed.

#### **i** Information

If there is heavy accumulation of snow or ice on the windscreen, defrost the windscreen for about 10 minutes, or until the snow and/or ice is removed to prevent damage to the wiper and washer system.

---

### Front windscreen washers



In the OFF position, pull the lever gently toward you to spray washer fluid on the windscreen and to run the wipers 1-3 cycles. The spray and wiper operation continues until you release the lever. If the washer does not work, you may need to add washer fluid to the washer fluid reservoir.

### **Recirculating air when washer fluid is used**

When washer fluid is used, in order to reduce any objectionable scent of the washer fluid from entering the cabin, recirculation mode and air conditioning are automatically activated depending on the outside temperature. If you select fresh mode whilst the function is operating, the function resumes after a certain amount of time. It may not work in some conditions such as cold weather or vehicle OFF.

For more information, refer to the "Climate control additional features" section in this chapter.

#### **⚠** WARNING

When the outside temperature is below freezing, always warm the windscreen using the defroster to help prevent the washer fluid from freezing on the windscreen and obscuring your vision that could lead to a collision resulting in serious injury or death.

Always use appropriate washer fluids in the winter season or cold weather.

---

#### **NOTICE**

To prevent damage:

- Do not operate the washer when the fluid reservoir is empty or when the windscreen is dry.
  - Do not operate the wipers when the windscreen is dry.
  - Do not attempt to move the wipers manually.
  - Use anti-freezing washer fluids in the winter season or cold weather.
-

## Rear windscreen wipers and washers

 if equipped



The rear window wiper and washer switch is located at the end of the wiper and washer switch lever. Turn the switch to the desired position to operate the rear wiper and washer.

- **HI:** High wiper speed
- **LO:** Low wiper speed
- **OFF:** Off



Push the lever away from you to spray rear washer fluid and to run the rear wipers 1-3 cycles. The spray and wiper operation continues until you release the lever.



## Manual climate control system

 if equipped



- (1) Temperature control
- (2) Fan speed control
- (3) Mode selection
- (4) Air intake control
- (5) A/C (air conditioning)
- (6) Front windscreen defroster

## Heating and air conditioning

1. Start the engine.
2. Set the mode to the desired position.  
To improve the effectiveness of heating and cooling, select:
  - Heating: 
  - Cooling: 
3. Set the temperature control to the desired position.
4. Set the air intake control to the outside (fresh) air position.
5. Set the fan speed control to the desired speed.

If air conditioning is desired, turn on the air conditioning system.

### ***Mode selection***

The mode selection knob controls the direction of the air flow through the ventilation system.

Air flow direction



Symbol	Operation	Direction
	Air flow is directed toward the upper body and face. Additionally, each outlet can be controlled to direct the air discharged from the outlet.	B, D, E
	Air flow is directed toward the face and the floor.	B, C, D, E
	Most of the air flow is directed to the floor, with a small amount of the air being directed to the windscreen and side window defrosters.	A, C, D
	Most of the air flow is directed to the floor and the windscreen with a small amount directed to the side window defrosters.	A, C, D
	Most of the air flow is directed to the windscreen with a small amount of air directed to the side window defrosters.	A, D



### Instrument panel vents

Front



Rear



You can adjust the direction of air delivered from these vents using the vent control lever as shown.

### Temperature control



The temperature increases by turning the knob to the right. The temperature decreases by turning the knob to the left.

### Air intake control

#### Recirculation mode



With the recirculated air selected, air from the passenger compartment is drawn through the climate control system.

#### Outside (fresh) mode



With the outside (fresh) air selected, air enters the vehicle from outside and is drawn through the climate control system.

**i Information**

Using the system in the fresh air position is recommended.

Prolonged operation of the heater in the recirculated air position (without air conditioning selected) can cause fogging of the windscreen and side windows and the air within the passenger compartment will become stale.

In addition, prolonged use of the air conditioning with the recirculated air position selected will result in excessively dry air in the passenger compartment.

**! WARNING**

To prevent serious injury or death:

- Continued climate control system operation in the recirculated air position may allow humidity to increase inside the vehicle that could fog the windscreen and the side windows and obscure visibility.
- Do not sleep in a vehicle with the air conditioning or heating system on.
- Continued climate use of recirculated air may cause drowsiness or sleepiness, and loss of vehicle control. Set the air intake control to the outside (fresh) air position whilst driving.

**Fan speed control**



Turn the knob to the right to increase the fan speed and airflow. Turn the knob to the left to decrease fan speed and airflow. Setting the fan speed control knob to the “0” position turns off the fan.

**i Information**

Operating the fan speed when the Engine Start/Stop button is in the ON position may cause the battery to discharge.

**Air conditioning (A/C)**



Press the A/C button to turn on the air conditioning system (indicator light ON). Press the button again to turn off the air conditioning system.



## System operation

### Ventilation

1. Set the mode to the  position.
2. Set the air intake control to the outside (fresh) mode.
3. Set the temperature control to the desired position.
4. Set the fan speed control to the desired speed.

### Heating

1. Set the mode to the  position.
2. Set the air intake control to the outside (fresh) mode.
3. Set the temperature control to the desired position.
4. Set the fan speed control to the desired speed.
5. If desired, turn the air conditioning ON with the temperature control knob set to heat in order to dehumidify the air before it enters into the cabin.

If the windscreen fogs up, set the mode to  the or  position.

### Operation tips

- To help keep dust or unpleasant fumes from entering the vehicle through the ventilation system, temporarily set the air intake control to the recirculation mode. Be sure to return the control to the fresh air mode when the irritation has passed to keep fresh air in the vehicle. This can help keep the driver alert and comfortable.
- To prevent interior fog on the windscreen, set the air intake control to the fresh air position and the fan speed to the desired position, turn on the air conditioning system, and adjust the temperature control to the desired temperature.

### Air conditioning

1. Start the engine. Press the air conditioning button.
2. Set the mode to the  position.
3. Set the air intake control to the outside air or recirculated air position.
4. Adjust the fan speed control and temperature control as desired.

### NOTICE

- When using the air conditioning system, monitor the temperature gauge closely whilst driving up hills or in heavy traffic when outside temperatures are high. Continue to use the fan but turn off the air conditioning system if the temperature gauge indicates the engine is overheating.
- Always use the air conditioning with the windows closed. In humid weather, if the windows are open and the air conditioning is running, water droplets may form inside the vehicle and potentially damage electrical equipment.

### Air conditioning system operation tips

- If the vehicle has been parked in direct sunlight during hot weather, open the windows for a short time to let the hot air inside the vehicle escape.
- After sufficient cooling has been achieved, switch back from the recirculated air position to the outside fresh air position.
- To help reduce moisture inside of the windows on rainy or humid days, decrease the humidity inside the vehicle by operating the air conditioning system with the windows and sunroof closed.
- Use the air conditioning system every month for a few minutes to ensure maximum system performance.

- If you operate the air conditioner excessively, the difference between the temperature of the outside air and that of the windscreen may cause the outer surface of the windscreen to fog up, causing loss of visibility. In this case, set the mode selection switch to the  position and set the fan speed control switch to the lowest speed setting.

## System maintenance

### **Cabin air filter**

The cabin air filter is installed behind the glove box. It filters the dust or other pollutants that enter the vehicle through the heating and air conditioning system.

We recommend that the cabin air filter be replaced by a HYUNDAI authorised repairer according to the Maintenance schedule. If the vehicle is being driven in severe conditions such as dusty or rough roads and/or if transporting pets or occupants smoke inside the vehicle, then more frequent cabin air filter inspections and changes are required.

### ***i* Information**

Replace the filter according to the Maintenance schedule. If the vehicle is being driven in severe conditions such as dusty, rough roads, more frequent climate control air filter inspections and replacement are required.

---

### **Checking the amount of air conditioner refrigerant**

If the amount of refrigerant is too low or too high, the performance of the air conditioning is reduced. We recommend that your vehicle be inspected by a HYUNDAI authorised repairer.

### **NOTICE**

- The refrigerant system should only be serviced by trained and certified technicians in a well-ventilated area to ensure proper and safe operation.
  - Never repair the air conditioning evaporator (cooling coil) or replace with the one removed from a used or salvaged vehicle. A new replacement evaporator must be certified (and labelled) as meeting SAE Standard J2842.
- 

### **WARNING**

**Vehicles equipped with R-134a**



To prevent serious injury, have the air conditioning system be serviced by only trained and certified technicians. R-134a is operated at high pressure.

Reclaim all refrigerants with proper equipment. Venting refrigerants directly to the atmosphere is harmful to individuals and environment.

---

## Automatic climate control system

<sup>+</sup> if equipped



The climate control system buttons may differ depending on vehicle specification.

- (1) Driver's temperature control
- (2) AUTO (automatic control)
- (3) A/C (air conditioning)
- (4) Mode selection
- (5) Fan speed control
- (6) Passenger's temperature control
- (7) OFF
- (8) Front windscreen defroster
- (9) Rear window defroster
- (10) Air intake control
- (11) SYNC
- (12) Climate control screen

## Automatic heating and air conditioning

The Automatic Climate Control System is controlled by setting the desired temperature.



1. Press the AUTO button. The modes, fan speeds, air intake, and air conditioning are controlled automatically by the temperature setting.
2. Push up or down the temperature control switch to set the desired temperature. If the temperature is set to the lowest setting, the air conditioning system operates continuously. After the interior has cooled sufficiently, adjust the switch to a higher temperature set point whenever possible.

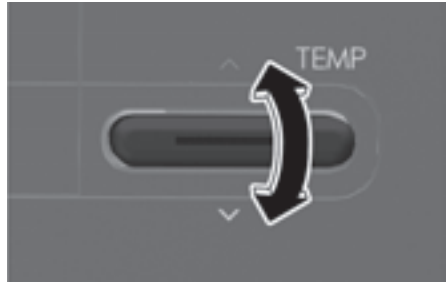

To turn off the automatic operation, select any switch of the following:

- Mode selection switch
- Front windscreen defroster button (Press the button one more time to deselect the front windscreen defroster function. The 'AUTO' sign illuminates on the information display once again.)
- Fan speed control switch
- A/C button

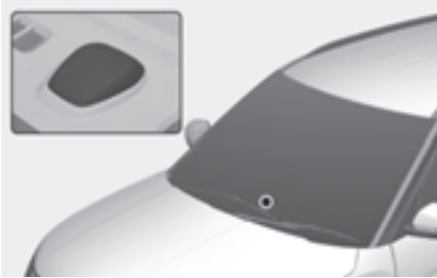

The selected function is controlled manually whilst other functions operate automatically.

For your convenience and to improve the effectiveness of the climate control, use the AUTO button and set the temperature to 22 °C (72 °F).

**NOTICE**

Never place anything near the sensor to ensure better control of the heating and cooling system.

## Manual heating and air conditioning

1. Start the engine.
2. Set the mode to the desired position.  
For improving the effectiveness of heating and cooling, select:
  - Heating: 
  - Cooling: 
3. Set the temperature control to the desired position.
4. Set the air intake control to the outside (fresh) air position.
5. Set the fan speed control to the desired speed.
6. If air conditioning is desired, turn on the air conditioning system.
7. Press the AUTO button to convert to full automatic control of the system.

## Mode selection



The mode selection switch controls the direction of the air flow through the ventilation system.

Air flow direction



Symbol	Operation	Direction
	Air flow is directed toward the upper body and face. Additionally, each outlet can be controlled to direct the air discharged from the outlet.	B, D, E
	Air flow is directed toward the face and the floor.	B, C, D, E
	Most of the air flow is directed to the floor, with a small amount of the air being directed to the windscreen and side window defrosters.	A, C, D
	Most of the air flow is directed to the floor and the windscreen with a small amount directed to the side window defrosters.	A, C, D



### Front windscreen defroster [A], [D]



Press the A/C button to manually turn on the system on (indicator light ON) and off. Press the front windscreen defroster button (indicator light ON) to turn on the front windscreen defroster. If the windscreen defogging is set, outside (fresh) mode is automatically selected and the air conditioning turns on according to the detected ambient temperature

Press the front windscreen defroster button once more (indicator light OFF) to turn the function off. Each climate control setting reverts to the setting prior to selecting the front windscreen defrost.

### Instrument panel vents

Front



Rear



The instrument panel vent air flow can be directed up/down or left/right using the vent adjustment lever.

The outlet vents can be opened or closed separately using the vent control lever.

### Temperature control

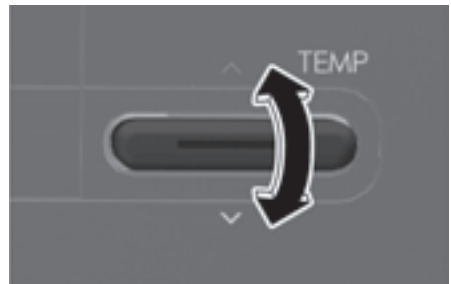

Push up the switch to increase the temperature. Push down to decrease the temperature.

### Temperature conversion (°C ↔ °F)

To change the temperature unit from °C to °F or °F to °C:

- Press the **A/C** button and press the **MODE** button within 5 seconds.
- Select **Settings > Unit > Temperature unit > °C/°F** in the infotainment system.

**SYNC (Adjusting the driver and passenger side temperature equally)**



**Adjusting the temperature and air flow direction equally**

Press the SYNC button (indicator light ON) to adjust the driver and passenger side temperature and air flow direction equally.

**Adjusting the temperature individually**

Press SYNC button (indicator light OFF) again to adjust the driver and passenger side temperature individually.

**Air intake control**

**Recirculation mode**



With the recirculated air selected, air from the passenger compartment is drawn through the climate control system.

**Outside (fresh) mode**



With the outside (fresh) air selected, air enters the vehicle from outside and is drawn through the climate control system.

***i* Information**

Using the system in the fresh air position is recommended.

Prolonged operation of the heater in the recirculated air position (without air conditioning selected) can cause fogging of the windscreen and side windows and the air within the passenger compartment will become stale.

In addition, prolonged use of the air conditioning with the recirculated air position selected will result in excessively dry air in the passenger compartment.

## WARNING

To prevent serious injury or death:

- Continued climate control system operation in the recirculated air position may allow humidity to increase inside the vehicle that could fog the windscreen and the side windows and obscure visibility.
- Do not sleep in a vehicle with the air conditioning or heating system on.
- Continued climate use of recirculated air may cause drowsiness or sleepiness, and loss of vehicle control. Set the air intake control to the outside (fresh) air position whilst driving.

### *Fan speed control*



Push the right button to increase fan speed and airflow. Push the left button to decrease fan speed and airflow.

Pressing the OFF button turns off the fan.

## *i* Information

Operating the fan speed when the Engine Start/Stop button is in the ON position may cause the battery to discharge.

### *Air conditioning*

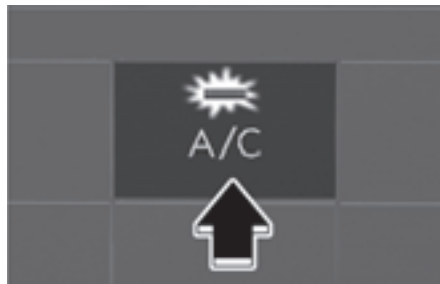

Press the A/C button to manually turn on the system on (indicator light ON) and off.

### *OFF mode*



Press the OFF button to turn the climate control system off. You can still operate the mode and air intake buttons as long as the Engine Start/Stop button is in the ON position.

## System maintenance

### **Cabin air filter**

The cabin air filter is installed behind the glove box. It filters the dust or other pollutants that enter the vehicle through the heating and air conditioning system.

We recommend that the cabin air filter be replaced by a HYUNDAI authorised repairer according to the Maintenance schedule. If the vehicle is being driven in severe conditions such as dusty or rough roads and/or if transporting pets or occupants smoke inside the vehicle, then more frequent cabin air filter inspections and changes are required.

### **i Information**

- Replace the filter according to the Maintenance schedule. If the vehicle is being driven in severe conditions such as dusty, rough roads, more frequent climate control air filter inspections and changes are required.
  - When the air flow rate suddenly decreases, we recommend that your vehicle be inspected by a HYUNDAI authorised repairer.
- 

### **Checking the amount of air conditioner refrigerant**

If the amount of refrigerant is too low or too high, the performance of the air conditioning is reduced. We recommend that your vehicle be inspected by a HYUNDAI authorised repairer.

### **NOTICE**

- The refrigerant system should only be serviced by trained and certified technicians in a well-ventilated area to ensure proper and safe operation.
  - Never repair the air conditioning evaporator (cooling coil) or replace with the one removed from a used or salvaged vehicle. A new replacement evaporator must be certified (and labelled) as meeting SAE Standard J2842.
- 

### **⚠ WARNING**

#### **Vehicles equipped with R-134a**



To prevent serious injury, have the air conditioning system be serviced by only trained and certified technicians. R-1234yf is operated at high pressure.

Reclaim all refrigerants with proper equipment. Venting refrigerants directly to the atmosphere is harmful to individuals and environment.

---

## Windscreen defrosting and defogging

### WARNING

Do not use the defrost level  position during cooling operation in extremely humid weather. The outer surface of the windscreen may fog and reduce visibility, causing a collision that results in serious injury or death.

Set the mode selection button to the face level  position and lower the fan speed.

- For maximum defrost performance, set the temperature control switch to the highest temperature setting and the fan speed control to the highest setting.
- If warm air to the floor is desired whilst defrosting or defogging, select the floor defrost position.
- Before driving, clear all snow and ice from the windscreen, rear window, outside rearview mirrors, and all side windows.
- Clear all snow and ice from the bonnet and air inlet to improve heater and defroster efficiency and to reduce the probability of fogging up the inside of the windscreen.

## Manual climate control system

### To defog inside windscreen



- (1) Select any fan speed.
- (2) Select the desired temperature.
- (3) Select the front windscreen defroster.
- (4) The outside (fresh) air is selected automatically. The air conditioning automatically operates if the mode is selected to the defrost level position.

If the air conditioning and outside (fresh) air position are not selected automatically, press the corresponding button.

**To defrost outside windscreen**



- (1) Set the fan speed to the highest (extreme right) position.
- (2) Set the temperature to the hottest (extreme right) position.
- (3) Select the front windscreen defroster.
- (4) The outside (fresh) air and air conditioning is selected automatically.

**Automatic climate control system**

**To defog inside windscreen**

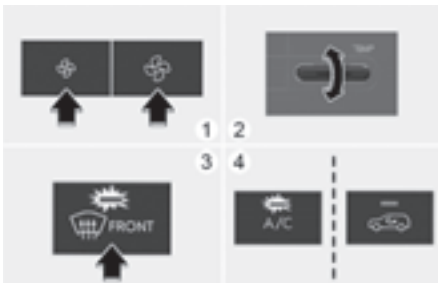

- (1) Select the desired fan speed.
- (2) Select the desired temperature.
- (3) Press the defroster button (☀️)
- (4) The air conditioning turns on according to the detected ambient temperature, the outside (fresh) air mode and higher fan speed are selected automatically.

If the air conditioning, outside (fresh) air mode and higher fan speed are not selected automatically, adjust the corresponding switch.

If the defrost switch is selected, the fan speed increases.

**To defrost outside windscreen**

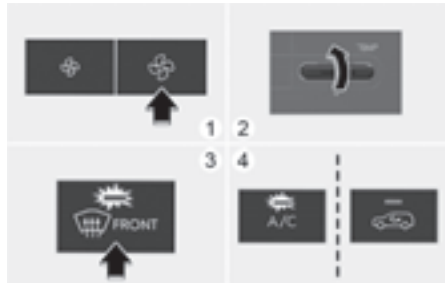

- (1) Set the fan speed to the highest position.
- (2) Set the temperature to the hottest (HI) position.
- (3) Press the defroster button (☀️)
- (4) The air conditioning turns on according to the detected ambient temperature and the outside (fresh) air mode is selected automatically.

If the defrost switch is selected, lower fan speed is adjusted to higher fan speed.

## Defogging logic

To reduce the probability of fogging up the inside of the windscreen, the air intake or air conditioning are controlled automatically according to certain conditions. To cancel or reset the defogging logic, do the following.

1. Press the Engine Start/Stop button to the ON position.
2. Press the defroster button (☀️).
3. Press the air intake control button at least 5 times within 3 seconds.

The air intake control button indicator blinks 3 times to indicate that the defogging logic has been disabled. Repeat the steps again to re-enable the defogging logic.

If the battery has been discharged or disconnected, it resets to the defog logic status

## Rear window defroster

### NOTICE

Never use sharp instruments or window cleaners containing abrasives to clean the window to prevent damage to the rear window defroster.

The defroster heats the window to remove frost, fog and thin ice from the interior and exterior of the rear window, whilst the engine is running.

- To activate it, press the rear window defroster button located in the centre control panel. The indicator on the rear window defroster button illuminates when the defroster is ON.

Manual climate control system



Automatic climate control system



- To turn it off, press the rear window defroster button again.

### *i* Information

- If there is heavy accumulation of snow on the rear window, brush it off before operating the rear defroster.
- The rear window defroster automatically turns off after about 20 minutes or when the Engine Start/Stop button is in the OFF position.

## Climate control additional features

### **i** Information

The infotainment system may change after software updates. For more information, refer to the manual provided in the infotainment system and the quick reference guide.

---



### Auto dehumidify

 If equipped

To increase cabin air quality and reduce windscreen misting, recirculation mode switches off automatically after about 5 to 30 minutes, depending on the outside temperature, and the air intake changes to fresh mode.

#### **Turning Auto dehumidify on or off**

##### Climate control system

To turn the Auto dehumidify feature on or off, select Face level () mode and press the air intake control () button at least 5 times within 3 seconds. When Auto dehumidify is turned on, the air intake control button indicator blinks 6 times. When turned off, the indicator blinks 3 times.

##### Infotainment system

Auto dehumidify can be turned on and off by selecting **Settings > Vehicle > Climate > Automatic ventilation > Auto dehumidify** from the infotainment system.

## Sunroof inside air recirculation

 If equipped

When the sunroof is opened, the fresh mode is automatically selected. When the sunroof is closed, the air intake position returns to the previous position. If you press the air intake control button when the sunroof is opened and the fresh mode is automatically changed, the recirculation mode is selected but it can not be returned to fresh mode when the sunroof is closed.

## Recirculating air when washer fluid is used

 If equipped

Recirculation mode automatically activates to reduce the scent of the washer fluid entering the cabin when the windscreen washer is used.

When it is shifted to the recirculation mode, the unpleasant scent may not flow into the vehicle.



## Turning Activation on a washer fluid use on or off

### Climate control system

To turn the Activate on washer fluid use feature on or off, select Floor level (الارض) mode, and then press the air intake control (التهوية) button 5 times within 3 seconds.

When Activate on washer fluid use is turned on, the air intake control button indicator blinks 6 times. When turned off, the indicator blinks 3 times.

### Infotainment system

Activate on washer fluid use can be turned on and off by selecting **Settings > Vehicle > Climate > Internal air circulation > Activation on washer fluid use** from the infotainment system.

## Recirculating air when entering a tunnel

 if equipped

To prevent the inflow of polluted air into the vehicle when passing through a tunnel, the climate control system is operated using the navigation map information and vehicle speed as follows:

To use this feature, it can be enabled from the infotainment system. Press the **SETUP** button, and then select **Vehicle > Climate > Internal air circulation**

- **Tunnel section:** The climate control system switches to recirculation mode before entering a tunnel.

### Operating conditions

- The climate control system's recirculation mode is selected.

### Information

- The activation time for the feature may differ because of the time gap between the GPS and vehicle speed.
- The feature activates until you have passed through continuous tunnels.
- When entering a tunnel, recirculation mode may cause fogging of the windscreen. Use the front windscreen defroster button.
- The feature does not operate in short tunnels.
- The feature may not activate if the GPS is not working properly.
- The infotainment system may change after software updates. For more information, refer to the manual provided in the infotainment system and the quick reference guide.

## Storage compartment

### WARNING

Never store cigarette lighters, propane cylinders, or other flammable/explosive materials in the vehicle. These items may catch fire and/or explode if the vehicle is exposed to hot temperatures for extended periods.

---

### WARNING

ALWAYS keep the storage compartment covers closed securely whilst driving. Items inside your vehicle are moving as fast as the vehicle. If you have to stop or turn quickly, or if there is a collision, the items may fly out of the compartment and may cause an injury if they strike the driver or a passenger.

---

### NOTICE

To avoid possible theft, do not leave valuables in the storage compartments.

---

## Centre console storage



To open:  
Pull up the storage cover.

## Glove box



To open:  
Pull the lever (1).

### WARNING

ALWAYS close the glove box door after use.

An open glove box door may cause serious injury to a passenger in a collision, even if the passenger is wearing a seat belt.

---

## Cool box

 if equipped

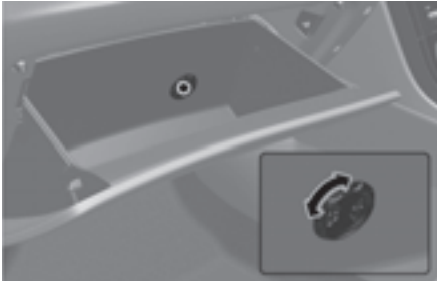

You can keep beverage cans or other items cool in the glove box.

1. Turn on the air conditioning.
2. Turn the open/close switch of the vent installed in the glove box to the open position.
3. When the cool box is not used, turn the switch to the closed position.

### WARNING

Do not put perishable food in the cool box because it may not maintain the necessary consistent temperature to keep the food fresh.

### *i* Information

- If the vent is blocked by items in the cool box, cooling will be reduced.
- If the climate control system temperature control is in the warm or hot position, Cold air only will flow into the glove box.

## Passenger seat open tray



You can use this space to store small items etc.



- Insert the screwdriver into the hole located in the tray, lift the tray up and pull it away slightly in the direction of the seat.
- After cleaning, assemble it again by fixing the snaps into holes.

### WARNING

Do not put any sharp object in the open tray. It may seriously injure you in the event of a sudden stop or a collision.

## Interior features

### Cup holder

Cups or small beverage cups can be placed in the cup holders.

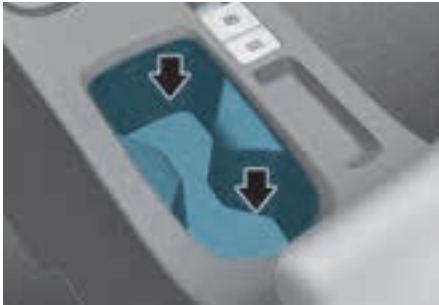

Cups or small beverage cans may be placed in the cup holders.

Rear seat armrest (if equipped)



Pull the armrest down to use the cup holders.

### WARNING

- Avoid abrupt starting and braking when the cup holder is used to prevent spilling your drink. If hot liquid spills, you may be burned. Such a burn to the driver may cause loss of vehicle control resulting in a collision.
- Only use soft cups in the cup holders.

### NOTICE

- Keep your drinks sealed whilst driving to prevent spilling. If liquid spills, it may get into the vehicle's electrical/electronic system and damage electrical/electronic parts.
- When cleaning spilled liquids do not use hot air to blow out or dry the cup holder. This may damage the interior.
- Keep cans or bottles out of direct sun light and do not put them in a hot vehicle. Otherwise, they may explode.

### Sunvisor

Driver's side



Passenger's side



To use the sunvisor, pull it downward.

To use the sunvisor to block the sun from the side window, pull it rearward, release it from the bracket (1) and swing it to the side (2) toward the window.

Use the ticket holder (3) to hold tickets.  
To use the vanity mirror, pull down the sunvisor (for passenger's side).

### WARNING

Do not block your view or the roadway when using the sunvisor.

## Magnetic pad



The driver side panel is a pad to attach light items such as tickets, receipts, etc., by using its magnetic surface.

### NOTICE

Do not attach heavy items such as cellular phones. Dropping whilst driving, the items can be damaged.

### WARNING

Do not attach the cellular phones and heavy or sharp items to the cluster fascia side panel for safety reason.

This could result in loss of control, and an accident causing death, serious injury, or property damage.

## Power outlet



The power outlet is designed to provide power for mobile phones or other devices designed to operate with vehicle electrical systems.

The devices should draw less than 180 W with the engine running.

### WARNING

Avoid electrical shocks. Do not place your fingers or foreign objects (pin, etc.) into a power outlet or touch the power outlet with a wet hand.

### NOTICE

To prevent damage to the power outlets:

- Use the power outlet only when the engine is running and remove the accessory plug after use. Using the accessory plug for an extended period of time with the engine off could cause the battery to discharge.
- Only use 12 V electric accessories that are less than 180 W in electric capacity.
- Adjust the air conditioner or heater to the lowest operating level when using the power outlet.
- Close the cover when not used.
- Some electronic devices may cause electronic interference when plugged into a vehicle's power outlet.
- Push the plug in as far as it goes. The plug may overheat and the fuse may open.

- Only connect devices with reverse current protection or the current from the device battery may cause the vehicle's electrical/electronic system to malfunction.
- 

### USB charger

The USB charger is designed to recharge batteries of small size electronic devices using a USB cable.

Front



Rear



The USB charger is designed to recharge batteries of small size electronic devices using a USB cable.

Electronic devices can be charged when the engine is running.

### *i* Information

- The battery charging state may be monitored on the electronic device.
  - Disconnect the USB cable from the USB port after use.
  - A smartphone or a tablet PC may get warmer during the recharging process. It does not indicate any malfunction with the charging system.
  - A smartphone or a tablet PC that does not use a USB cable to charge should be charged using its own charger.
  - Do not attempt to use the charging terminal either to turn on an audio or to play media with the infotainment system.
  - Charging may not be possible when using a Type-C to A converter sold by a mobile phone manufacturer or commercially available.
-

**NOTICE**

- Use the USB charger when the engine is running. Using the USB charger for prolonged periods of time with the Engine Start/Stop button in the ON position (engine off) may cause the battery to discharge.
- To prevent damage to the USB charger:
  - Do not insert foreign objects or spill liquid into the outlet. The USB charging terminal may be damaged.
  - Do not use devices with working current exceeding 3,000 mA (3.0 A).
- When charging an electrical device by using an USB converting adapter (C to A type), use a genuine adapter specified for your vehicle. A commonly used adapter is not equipped with any measures to prevent over current and maintain stability.  
Using an unspecified cable may damage the vehicle's USB charger or the connected devices. We recommend that you contact a HYUNDAI authorised repairer for more information on accessories for HYUNDAI vehicles.
- The use of non-genuine parts may damage the USB port and infotainment system. Damage cannot be covered by your vehicle warranty.

**Wireless smartphone charging system**

 if equipped



- (1) Indicator light  
(2) Charging pad

**Charging your smartphone**

The wireless smartphone charging system charges only the Qi-enabled smartphones (📱). Visit your smartphone manufacturer's website to check whether your smartphone supports the Qi technology.

The wireless charging process starts when you put a Qi-enabled smartphone on the wireless charging with the screen facing up.

1. The wireless smartphone charger is available when all doors are closed, and when the Engine Start/Stop button is in the ON or START position.
2. Turn on the wireless charging function from the Settings menu in the infotainment system.
  - Select: **Settings > Vehicle > Convenience > Wireless charging system for mobile devices**

- Place the smartphone on the centre of the wireless charging pad. The indicator light is amber when the smartphone is charging and turns green when phone charging is complete.

### **i** Information

- Remove other items, including the smart key from the wireless charging pad.
- For flip type smartphones, when using wireless charging, place the smartphone folded with the device's back placed on the centre of the wireless charging unit.

---

If your smartphone is not charging:

- Move the smartphone on the charging pad.
- Make sure the indicator light is amber.

The indicator light blinks amber for 10 seconds if there is a malfunction in the wireless charging system.

The system warns you with a message on the cluster display if the smartphone is still on the wireless charging pad after the vehicle is turned OFF and the front door is opened.

### **NOTICE**

To prevent liquid from damaging the wireless smartphone charging system in your vehicle, be sure not to spill liquid over the charging system when charging your phone.

---

### **NOTICE**

- The wireless smartphone charging system may not support certain smartphones, that do not meet for the Qi specification (Qi).
- When placing your smartphone on the charging pad, position the phone in the middle of the mat for optimal charging performance. If your smartphone is off to the side, the charging rate may be less and in some cases the smartphone may experience higher heat conduction.
- Wireless charging may stop temporarily when the smart key is used, either when starting the vehicle or locking/unlocking the doors, etc.
- When charging certain smartphones, the charging indicator may not change to green when the smartphone is fully charged.
- The wireless charging process may temporarily stop, when temperature abnormally increases inside the wireless smartphone charging system. The wireless charging process does not restart, until the temperature falls.
- The wireless charging process may temporarily stop when there is any metallic item, such as a coin, between the wireless smartphone charging system and smartphone.
- For some manufacturer's smart phones, the system may not warn you even though the smart phone is left on the wireless charging unit. This is due to the particular characteristic of the smart phone and not a malfunction of the wireless charging.



- When charging some smartphones with a self-protection feature, the wireless charging speed may decrease and the wireless charging may stop.
- For flip type smartphones, when using wireless charging, place the smartphone folded with the device's back placed on the centre of the wireless charging unit.
- If the smartphone has a thick case, it may not charge.
- Some magnetic items such as credit cards, phone cards, or transit cards may be damaged if left with the smartphone during the charging process.
- If the smartphone is not completely contacting the charging pad, wireless charging may not operate properly.
- If the Engine Start/Stop button is in the OFF position, the charging also stops.
- When any smartphone without a wireless charging function or a metallic object is placed on the charging pad, a small noise may sound. This small sound because the vehicle discerns compatibility of the object placed on the charging pad. It does not affect your vehicle or the smartphone.
- Some smartphones may not be able to charge depending on the internal structure of the smartphone. If this occurs, try charging the smartphone by moving it to the left or right side of the wireless charging pad. However, for some fold-able smartphones that have magnets inside the smartphone, try charging the smartphone whilst holding it close to the left side of the wireless charging pad.

### NOTICE

Some magnetic items like credit cards, phone cards or rail tickets may be damaged if left with the smartphone during the charging process.

### Clock

The clock can be set from the infotainment system.

#### WARNING

Do not attempt to adjust the clock whilst driving.

### Floor mat anchor(s)

ALWAYS use the floor mat anchors to attach the front floor mats to the vehicle. The anchors on the front floor carpet keep the floor mats from sliding forward.

#### WARNING

To prevent serious injury or death from a floor mat interfering with the brake or accelerator pedals:

- Remove any protective film on the carpet before installing a floor mat.
- Check floor mats are securely attached to the vehicle's floor mat anchors before driving.
- Do not use ANY floor mat that cannot be firmly attached to the vehicle's floor mat anchors.
- Do not stack floor mats on top of one another (e.g. all-weather rubber mat on top of a carpeted floor mat). Only a single floor mat must be installed in each position.

#### WARNING

To avoid any interference with pedal operation, HYUNDAI recommends that the HYUNDAI floor mat designed for use in your vehicle be installed.

## Cargo area cover

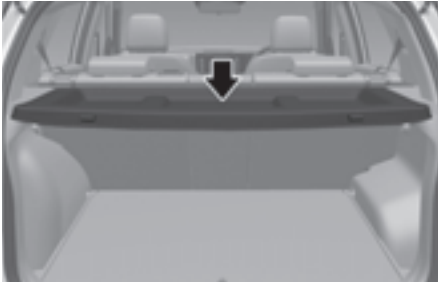

Use the cargo area cover to hide items stored in the cargo area.

The cargo area cover can be uprighted or removed.

### **WARNING**

- Do not place objects on the cargo area cover. Such objects may be thrown about inside the vehicle and possibly injure vehicle occupants during an accident or braking.
- Never allow anyone to ride in the luggage compartment. It is designed for luggage only.

### **NOTICE**

Do not put luggage on the cover since it may be damaged or malformed.

---

## Cargo tray

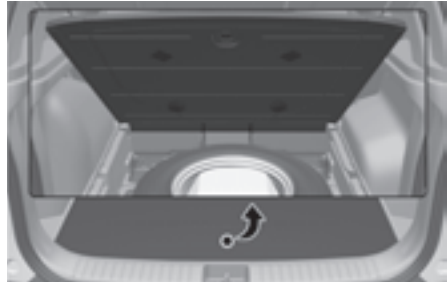

Use the cargo tray to organize and store small items such as tools. To use the tray, lift the top board with its handle.

### **CAUTION**

- When storing small or easily movable items, they may cause noise whilst driving.
  - Do not store fragile items in the cargo tray.
-

## Exterior features

### Roof rack

 if equipped

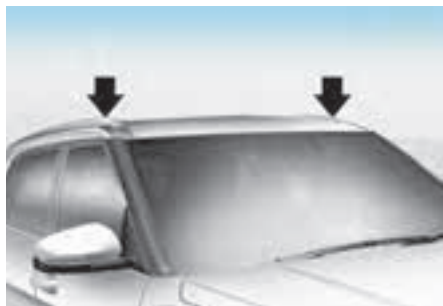

Do not load cargo on the roof.  
The roof rack is not for loading cargo but for aesthetic purpose.

## Infotainment system

### NOTICE

- Do not install an aftermarket HID headlight. Your vehicle's audio and electronic devices may not function properly.
- Prevent chemicals such as perfume, cosmetic oil, sun cream, hand cleaner, and air freshener from contacting the interior parts because they may cause damage or discolouration.

### USB port

 if equipped



You can use a USB port to plug in USB to play music.

### *i* Information

- Please go through USB compatibility list in HYUNDAI India website.
- When using a portable audio device connected to the power outlet, noise may occur during playback. If this happens, use the power source of the portable audio device.

## Antenna

### Pole antenna (if equipped)



The antenna receives both AM and FM broadcast signals.

This antenna pole is removable.

Rotate the antenna in a counterclockwise direction to remove it.

Rotate it in a clockwise direction to reinstall it.

### NOTICE

- Before entering a place with a low height clearance or a car wash, remove the antenna pole by rotating it counterclockwise. If not, the antenna may be damaged.
- When reinstalling the antenna, it is important that it is fully tightened and adjusted to the upright position to ensure proper reception.

### Shark fin antenna (if equipped)



The roof antenna transmits and receives wireless signals such as AM/FM, GNSS etc. The signals which antenna can transmit and receive vary by the vehicle option.

## Steering wheel remote controls

Type A



Type B



**NOTICE**

Do not operate multiple audio remote control buttons simultaneously.

**VOLUME (VOL + / VOL -)**

Push the lever up or down to adjust the volume.

**SEEK/PRESET (^ / v)**

If the SEEK/PRESET switch is pushed up or down and held for 0.8 seconds or more, it functions in the following modes:

- RADIO mode  
It functions as the AUTO SEEK select button. It seeks until you release the button.
- MEDIA mode  
It functions as the FF/RW button.

If the SEEK/PRESET switch is pushed up or down, it functions in the following modes:

- RADIO mode  
It functions as the PRESET STATION UP/DOWN button.
- MEDIA mode  
It functions as the TRACK UP/ DOWN button.

**MODE**

Press the MODE button to toggle through Radio mode.

**MUTE (M)**

Press the VOLUME lever to mute or activate the sound.

**CUSTOM (★) (if equipped)**

Press the custom button to set frequently used features.

**Infotainment system**

 if equipped



For more information, refer to the separately supplied infotainment system manual.

**Voice recognition**

 if equipped



See additional information in supplied Infotainment Manual.

## Bluetooth® wireless technology

 if equipped

Steering wheel



Map lamp (Type A)



Map lamp (Type B)



- (1) Call/Answer/End button
- (2) Microphone

For more information, refer to the separately supplied infotainment system manual.

### CAUTION

To prevent driver distractions, minimise your use of these features whilst driving. Distraction may cause a collision, resulting in serious injury or death.

## How vehicle radio works

 if equipped

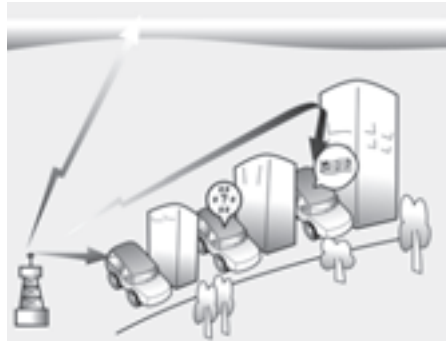

AM and FM radio signals are broadcast from transmitter towers located around your city. They are intercepted by the radio antenna on your vehicle. This signal is then processed by the radio and sent to your vehicle speakers.

When a strong radio signal has reached your vehicle, the precise engineering of your audio system ensures the best possible quality reproduction. However, in some cases the signal coming to your vehicle may not be strong and clear.

This can be due to factors, such as the distance from the radio station, closeness of other strong radio stations or the presence of buildings, bridges or other large obstructions in the area.

### ***AM reception***

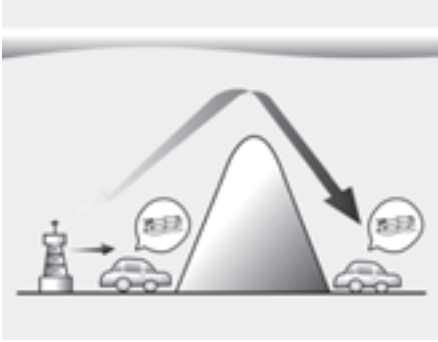

AM broadcasts can be received at greater distances than FM broadcasts. This is because AM radio waves are transmitted at low frequencies. These long, low frequency radio waves can follow the curvature of the earth rather than travelling straight out into the atmosphere. In addition, they curve around obstructions so that they can provide better signal coverage.

### ***FM radio station***



FM broadcasts are transmitted at high frequencies and do not bend to follow the earth's surface. Because of this, FM broadcasts generally begin to fade at short distances from the station. Also, FM signals are easily affected by buildings, mountains, or other obstructions.

These can result in certain listening conditions which might lead you to believe a problem exists with your radio. The following conditions are normal and do not indicate radio trouble:

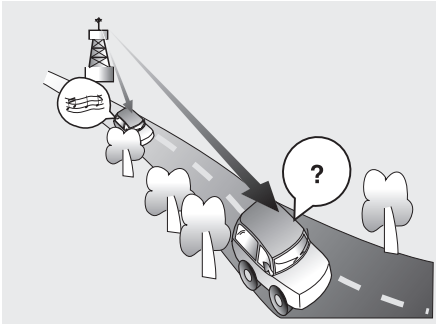

- Fading - As your vehicle moves away from the radio station, the signal will weaken and sound will begin to fade. When this occurs, we suggest that you select another stronger station.
- Flutter/Static - Weak FM signals or large obstructions between the transmitter and your radio can disturb the signal causing static or fluttering noises to occur. Reducing the treble level may lessen this effect until the disturbance clears.

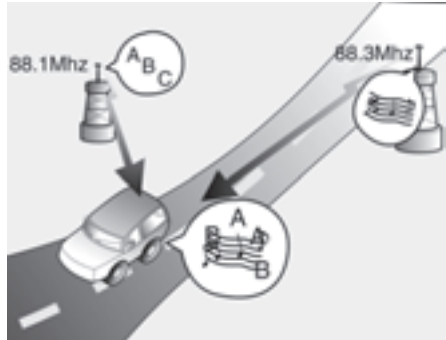

- Station Swapping - As a FM signal weakens, another more powerful signal near the same frequency may begin to play. This is because your radio is designed to lock onto the clearest signal. If this occurs, select another station with a stronger signal.
- Multi-Path Cancellation - Radio signals being received from several directions can cause distortion or fluttering. This can be caused by a direct and reflected signal from the same station, or by signals from two stations with close frequencies. If this occurs, select another station until the condition has passed.

### ***Using a cellular phone or a two-way radio***

When a cellular phone is used inside the vehicle, noise may be produced from the audio system. This does not mean that something is wrong with the audio equipment. In such a case, use the cellular phone at a place as far as possible from the audio equipment.



**NOTICE**

When using a communication system such as a cellular phone or a radio set inside the vehicle, a separate external antenna must be fitted. When a cellular phone or a radio set is used with an internal antenna alone, it may interfere with the vehicle's electrical system and adversely affect safe operation of the vehicle.

---

**⚠ WARNING**

Do not use a cellular phone while driving. Stop at a safe location to use a cellular phone.

---

***iPod***<sup>®</sup>

iPod<sup>®</sup> is a registered trademark of Apple Inc.

***Bluetooth***<sup>®</sup> ***Wireless Technology***

The Bluetooth<sup>®</sup> word mark and logos are registered trademarks owned by Bluetooth SIG, Inc. and any use of such marks by HYUNDAI is under license.

Other trademarks and trade names are those of their respective owners.

A Bluetooth<sup>®</sup> Wireless Technology enabled cell phone is required to use Bluetooth<sup>®</sup> Wireless Technology.





# 6. Driving Your Vehicle

Before driving .....	6-3
Before entering the vehicle.....	6-4
Before starting .....	6-4
Ignition switch .....	6-5
Key ignition switch.....	6-5
Engine Start/Stop button .....	6-8
Automatic transmission .....	6-15
Automatic transmission operation .....	6-16
Paddle shifter (manual shift mode) .....	6-18
Good driving practices .....	6-19
Manual transmission .....	6-20
Manual transmission operation .....	6-20
Intelligent Variable Transmission .....	6-22
Intelligent Variable Transmission (Shift lever type).....	6-23
Parking .....	6-27
Good driving practices .....	6-27
Dual clutch Transmission.....	6-29
Dual clutch Transmission .....	6-31
Paddle shifter (manual shift mode) .....	6-34
DCT warning messages.....	6-34
Parking .....	6-36
Good driving practices .....	6-36
Braking system .....	6-37
Power-assist brakes.....	6-37
Disc brakes wear indicator .....	6-38
Rear drum brakes.....	6-38
Parking brake (hand type) .....	6-38
Electronic Parking Brake (EPB) .....	6-40
Auto hold .....	6-43
Anti-Lock Braking System (ABS).....	6-45
Electronic Stability Control (ESC) .....	6-46
Vehicle Stability Management (VSM).....	6-49
Hill-Start Assist Control (HAC) .....	6-49
Emergency Stop Signal (ESS).....	6-50
Good braking practices .....	6-50
Idle Stop and Go (ISG).....	6-51

ISG System Operation ..... 6-51

ISG System off ..... 6-53

Conditions that restart the engine ..... 6-53

ISG Malfunction ..... 6-54

Calibrating the Battery Sensor ..... 6-54

Drive mode integrated control system ..... 6-55

    Selecting drive mode ..... 6-55

    Selecting traction control mode ..... 6-56

Special driving conditions ..... 6-58

    Hazardous driving conditions ..... 6-58

    Rocking the vehicle ..... 6-58

    Smooth cornering ..... 6-58

    Driving at night ..... 6-59

    Driving in the rain ..... 6-59

    Driving in flooded areas ..... 6-59

    Highway driving ..... 6-60

Winter driving ..... 6-61

    Snow or icy conditions ..... 6-61

    Winter precautions ..... 6-62

Vehicle weight ..... 6-64

    Overloading ..... 6-64

## Before driving

### **WARNING**

**Carbon monoxide (CO) gas is toxic. Breathing CO may cause unconsciousness and death.**

Engine exhaust contains carbon monoxide that cannot be seen or smelled.

**Do not inhale engine exhaust.**

If at any time you smell engine exhaust inside the vehicle, open the windows immediately. Exposure to CO may cause unconsciousness and death by asphyxiation.

**Make sure the exhaust system does not leak.**

Be sure to check the exhaust system whenever the vehicle is raised to change the oil or for any other purposes. If you hear a change in the sound of the exhaust or drive over something that strikes the underneath side of the vehicle, we recommend that the exhaust system be inspected as soon as possible by a HYUNDAI authorised repairer.

**Do not run the engine in an enclosed area.**

Letting the engine idle in your garage, even with the garage door open, is a hazardous practice. Run the engine only long enough to start the engine and to move the vehicle out of the garage.

**Avoid idling the engine for an extended period of time with people inside the vehicle.**

If it is necessary to idle the engine for a long time with people inside the vehicle, be sure to do so only in an open area with the air intake set at “Fresh” and fan control set to high so fresh air is drawn into the interior.

**Keep the air intakes clear.**

To ensure proper operation of the ventilation system, keep the ventilation air intakes located in front of the windscreen clear of snow, ice, leaves, or other obstructions.

**If you must drive with the tailgate open:**

Close all windows.

Open instrument panel air vents.

Set the air intake control at “Fresh”, the air flow control at “Floor” or “Face”, and the fan control set to high.

---

### Before entering the vehicle

- Make sure all windows, outside rearview mirror(s), and outside lights are clean and unobstructed.
- Remove frost, snow, or ice.
- Visually check the tyres for uneven wear and damage.
- Check under the vehicle for any sign of leaks.
- Make sure there are no obstacles behind you if you intend to back up.

### Before starting

Make sure the bonnet, the tailgate, and the doors are securely closed and locked.

Adjust the position of the seat and steering wheel.

Adjust the inside and outside rearview mirrors.

Verify all the lights work.

Fasten your seat belt. Check that all passengers have fastened their seat belts.

Check the gauges and indicators in the instrument panel and the messages on the cluster display when Engine Start/Stop button is in the ON position.

Check that any items you are carrying are stored properly or fastened down securely.

To reduce the risk of SERIOUS INJURY or DEATH, take the following precautions:

ALWAYS wear your seat belt. All passengers must be properly belted whenever the vehicle is moving. For more information, refer to “Seat belts” section in chapter 3.

Always drive defensively. Do not assume that the other drivers are seeing your vehicle. They may not act as you expect. Be prepared to react to avoid a possible collision. Plan your movements anticipating the “worst case” scenario.

Stay focused on driving. Driver distraction may cause a collision.

Leave plenty of space between you and the vehicle in front of you.

NEVER drink or take drugs whilst driving.

Drinking or taking drugs whilst driving is dangerous and may result in a collision, causing serious injury or death.

Drunk driving is the number one contributor to the highway death toll each year. Even a small amount of alcohol can affect your reflexes, perceptions and judgment. Just one drink may reduce your ability to respond to changing conditions and emergencies and your reaction time gets worse with each additional drink.

Driving whilst under the influence of drugs is as dangerous or more dangerous than driving under the influence of alcohol.

You are much more likely to have a serious accident if you are drinking or taking drugs, never drive. Do not ride with a driver who has been drinking or taking drugs. Choose a designated driver or call a taxi.

## Ignition switch

### WARNING

To reduce the risk of **SERIOUS INJURY** or **DEATH**, take the following precautions:

- NEVER allow children or any person who is unfamiliar with the vehicle to touch the ignition switch or related parts. Unexpected and sudden vehicle movement can occur.
- NEVER reach through the steering wheel for the ignition switch, or any other control, whilst the vehicle is in motion. The presence of your hand or arm in this area may cause a loss of vehicle control resulting in an accident.

## Key ignition switch

 if equipped

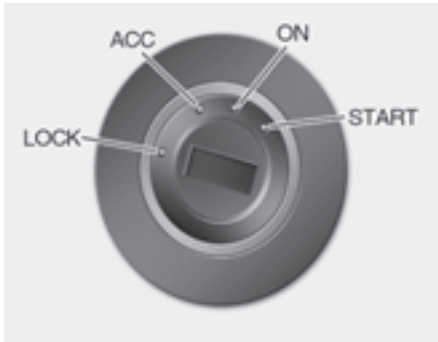

### WARNING

- NEVER turn the ignition switch to the LOCK or ACC position whilst the vehicle is in motion except in an emergency. This will result in the engine turning off and loss of power assist for the steering and brake systems. This may lead to loss of directional control and braking function, which could cause an accident.
- Before leaving the driver's seat, always make sure the shift lever is in 1st gear (for Manual transmission) or P (Park, for Intelligent variable transmission/Automatic transmission/Dual clutch transmission) position, apply the parking brake, and turn the ignition switch to the LOCK position.

Unexpected vehicle movement may occur if these precautions are not followed.

### NOTICE

Never use aftermarket keyhole covers. This may generate start-up failure due to communication failure.

**Key ignition switch positions**

Switch Position	Action	Notice
<b>LOCK</b>	The ignition key can be removed in the LOCK position. The steering wheel locks to protect the vehicle from theft (if equipped).	
<b>ACC</b>	Some of the electrical accessories are usable. The steering wheel unlocks.	If difficulty is experienced turning the ignition switch to the ACC position, turn the key whilst turning the steering wheel right and left to release.
<b>ON</b>	This is the normal key position when the engine has started. All features and accessories are usable. The warning lights can be checked when you turn the ignition switch from ACC to ON.	Do not leave the ignition switch in the ON position when the engine is not running to prevent the battery from discharging.
<b>START</b>	To start the engine, turn the ignition switch to the START position. The switch returns to the ON position when you let go of the key.	The engine will crank until you release the key.



## Starting the engine

### WARNING

- Always wear appropriate shoes when operating your vehicle. Unsuitable shoes, such as high heels, ski boots, sandals, flipflops, etc., may interfere with your ability to use the brake and accelerator pedals.
- Do not start the vehicle with the accelerator pedal depressed. The vehicle can move and lead to an accident.
- Wait until the engine RPM is normal. The vehicle may suddenly move if the brake pedal is released when the RPM is high.

## Starting the petrol engine

Vehicle with manual transmission:

1. Make sure the parking brake is applied.
2. Make sure the shift lever is in neutral.
3. Depress the clutch and brake pedals.
4. Turn the ignition switch to the START position. Hold the key (maximum of 10 seconds) until the engine starts and release it.

### Information

Depress the brake pedal and clutch pedal until the engine starts.

Vehicle with intelligent variable transmission/automatic transmission/dual clutch transmission:

1. Make sure the parking brake is applied.
2. Make sure the shift lever is in P (Park).
3. Depress the brake pedal.
4. Turn the ignition switch to the START position. Hold the key (maximum of 10 seconds) until the engine starts and release it.



### Information

- Do not wait for the engine to warm up whilst the vehicle remains stationary. Start driving at moderate engine speeds. (Steep accelerating and decelerating should be avoided.)
- Always start the vehicle with your foot on the brake pedal. Do not depress the accelerator whilst starting the vehicle. Do not race the engine whilst warming it up.

## Starting the diesel engine

To start the diesel engine when the engine is cold, it has to be pre-heated before starting the engine and then have to be warmed up before starting to drive.

Vehicle with manual transmission:

1. Make sure the parking brake is applied.
2. Make sure the shift lever is in neutral.
3. Depress the clutch and brake pedals.
4. Turn the ignition switch to the ON position to pre-heat the engine. The glow indicator light () will illuminate.
5. When the glow indicator light () goes out, turn the key ignition switch to the START position. Hold the key (maximum of 10 seconds) until the engine starts and release it.

Vehicle with automatic transmission:

1. Make sure the parking brake is applied.
2. Make sure the shift lever is in P (Park).
3. Depress the brake pedal.
4. Turn the ignition switch to the ON position to pre-heat the engine. The glow indicator light (⏻) will illuminate.
5. When the glow indicator light (⏻) goes out, turn the key ignition switch to the START position. Hold the key (maximum of 10 seconds) until the engine starts and release it.

### NOTICE

If the engine does not start within 10 seconds after preheating is completed, turn the ignition switch once more to the LOCK position and wait for 10 seconds. Then turn the ignition switch to the ON position in order to preheat the engine again.

---

### Starting and stopping the engine for turbocharger intercooler

1. Do not race or accelerate the engine immediately after starting the engine.  
If the engine is cold, idle for several seconds before sufficient lubrication is ensured in the turbo charger unit.
2. After high speed or extended driving that requires heavy engine load, idle the engine about one minute before turning the engine off.  
This idle time will allow the turbocharger to cool prior to shutting the engine off.

### NOTICE

Do not turn off the engine immediately after it has been subjected to a heavy load. Doing so may cause severe damage to the engine or turbo charger unit.

---

### NOTICE

To prevent damage to the vehicle:

- Do not hold the ignition key in the START position for more than 10 seconds. Wait 5 to 10 seconds before trying again.
  - Do not turn the ignition switch to the START position with the engine running. It may damage the starter.
  - If traffic and road conditions permit, you may put the shift lever in the N (Neutral) position whilst the vehicle is still moving and turn the ignition switch to the START position in an attempt to restart the engine.
  - Do not push or tow your vehicle to start the engine.
- 

## Engine Start/Stop button

 if equipped



Whenever the front door is opened, the Engine Start/Stop button will illuminate and will go off 30 seconds after the door is closed. (if equipped)

 **WARNING**

To turn the engine off in an emergency:

Press and hold the Engine Start/ Stop button for more than two seconds OR rapidly press and release the Engine Start/Stop button three times (within three seconds).

If the vehicle is still moving, you can restart the engine without depressing the brake pedal by pressing the Engine Start/Stop button with the shift lever in the N (Neutral) position.

---

 **WARNING**

- NEVER press the Engine Start/ Stop button whilst the vehicle is in motion except in an emergency. This will result in the engine turning off and loss of power assist for the steering and brake systems. This may lead to loss of directional control and braking function, which could cause an accident and severe damage to the Intelligent variable transmission.
  - Before leaving the driver's seat, always make sure the shift lever is in the P (Park) position, set the parking brake, press the Engine Start/ Stop button to the OFF position, and take the Smart Key with you. Unexpected vehicle movement may occur if these precautions are not followed.
-

**Engine Stop/Start button positions**

- Vehicle with manual transmission

Button Position	Action	Notes
<b>OFF</b>	To turn off the engine, stop the vehicle and then press the Engine Start/Stop button. The steering wheel locks to protect the vehicle from theft (if equipped).	If the steering wheel is not locked properly when you open the driver's door, the warning chime will sound.
<b>ACC</b>	Press the Engine Start/Stop button when the button is in the OFF position without depressing the clutch pedal. Some of the electrical accessories are usable. The steering wheel unlocks.	If you leave the Engine Start/Stop button in the ACC position for more than one hour, the battery power will turn off automatically to prevent the battery from discharging. If the steering wheel doesn't unlock properly, the Engine Start/Stop button will not work. Press the Engine Start/Stop button whilst turning the steering wheel right and left to release.
<b>ON</b>	Press the Engine Start/Stop button whilst it is in the ACC position without depressing the clutch pedal. The warning lights can be checked before the engine is started.	Do not leave the Engine Start/Stop button in the ON position when the engine is not running to prevent the battery from discharging.
<b>START</b>	To start the engine, depress the clutch and brake pedals and press the Engine Start/ Stop button with the shift lever in neutral.	If you press the Engine Start/Stop button without depressing the clutch pedal, the engine does not start and the Engine Start/Stop button changes as follows: <b>OFF &gt; ACC &gt; ON &gt; OFF or ACC</b>

### Engine Stop/Start button positions

- Vehicle with automatic transmission/IVT/dual clutch transmission

Button Position	Action	Notes
<b>OFF</b>	To turn off the engine, press the Engine Start/Stop with shift lever is in P (Park). The steering wheel locks to protect the vehicle from theft. (if equipped)	If the steering wheel is not locked properly when you open the driver's door, the warning chime will sound.
<b>ACC</b>	Press the Engine Start/Stop button when the button is in the OFF position without depressing the brake pedal. Some electrical accessories are usable. The steering wheel unlocks.	If you leave the Engine Start/Stop button in the ACC position for more than one hour, the battery power will turn off automatically to prevent the battery from discharging. If the steering wheel doesn't unlock properly, the Engine Start/Stop button will not work. Press the Engine Start/ Stop button whilst turning the steering wheel right and left to release tension.
<b>ON</b>	Press the Engine Start/Stop button whilst it is in the ACC position without depressing the brake pedal. The warning lights can be checked before the engine is started.	Do not leave the Engine Start/Stop button in the ON position when the engine is not running to prevent the battery from discharging.
<b>START</b>	To start the engine, depress the brake pedal and press the Engine Start/Stop button with the shift lever in the P (Park) or in the N (Neutral) position. For your safety, start the engine with the shift lever in the P (Park) position.	If you press the Engine Start/Stop button without depressing the brake pedal, the engine does not start and the Engine Start/Stop button changes as follows: <b>OFF &gt; ACC &gt; ON &gt; OFF or ACC</b>

### Starting the engine

#### WARNING

- Always wear appropriate shoes when operating your vehicle. Unsuitable shoes, such as high heels, ski boots, sandals, flipflops, etc., may interfere with your ability to use the brake, accelerator and clutch pedals.
  - Do not start the vehicle with the accelerator pedal depressed.  
The vehicle can move which can lead to an accident.
  - Wait until the engine RPM is normal. The vehicle may suddenly move if the brake pedal is released when the RPM is high.
- 

#### *i* Information

- The vehicle will start by pressing the Engine Start/Stop button, only when the smart key is in the vehicle.
  - Even if the smart key is in the vehicle, and when it is far away from the driver, the engine may not start.
  - When the Engine Start/Stop button is in the ACC or ON position, if any door is open, the system checks for the smart key. When the smart key is not in the vehicle, the “” indicator will blink and the warning 'Key not in vehicle' will come on. When all doors are closed, the chime will also sound for about 5 seconds. Keep the smart key in the vehicle.
- 

### Starting the petrol engine

Vehicle with manual transmission:

1. Always carry the smart key with you.
2. Make sure the parking brake is applied.
3. Make sure the shift lever is in neutral.
4. Depress the clutch and brake pedals.
5. Press the Engine Start/Stop button.

#### *i* Information

Depress the brake pedal and clutch pedal until the engine starts.

---

Vehicle with intelligent variable transmission/automatic transmission/dual clutch transmission:

1. Always carry the smart key with you.
2. Make sure the parking brake is applied.
3. Make sure the shift lever is in P (Park).
4. Depress the brake pedal.
5. Press the Engine Start/Stop button.

#### *i* Information

- Do not wait for the engine to warm up whilst the vehicle remains stationary. Start driving at moderate engine speeds. (Steep accelerating and decelerating should be avoided.)
  - Always start the vehicle with your foot on the brake pedal. Do not depress the accelerator whilst starting the vehicle. Do not race the engine whilst warming it up.
-

### Starting the diesel engine

To start the diesel engine when the engine is cold, it has to be pre-heated before starting the engine and then have to be warmed up before starting to drive.

Vehicle with manual transmission:

1. Always carry the smart key with you.
2. Make sure the parking brake is applied.
3. Make sure the shift lever is in neutral.
4. Depress the clutch and brake pedals.
5. Press the Engine Start/Stop button.
6. Continue depressing the brake pedal until the glow indicator light (🔥) goes out.
7. When the glow indicator light (🔥) goes out, the engine will start.

When you start to drive, move the shift lever after checking the RPM (revolutions per minute) is in the proper range (under 1000 RPM) by depressing the clutch pedal and brake pedal.

After releasing the parking brake, take your foot off the clutch and depress the accelerator slowly whilst starting your vehicle.

Vehicle with automatic transmission:

1. Always carry the smart key with you.
2. Make sure the parking brake is applied.
3. Make sure the shift lever is in P (Park).
4. Depress the brake pedal.
5. Press the Engine Start/Stop button.
6. Continue depressing the brake pedal until the glow indicator light (🔥) goes out.
7. When the glow indicator light (🔥) goes out, the engine will start.

When you start to drive, move the shift lever after checking the RPM (revolutions per minute) is in the proper range (under 1000 RPM) by depressing the brake pedal.

After releasing the parking brake, take your foot off the brake pedal and depress the accelerator slowly whilst starting your vehicle.

### Starting and stopping the engine for turbocharger intercooler

1. Do not race or accelerate the engine immediately after starting the engine.

If the engine is cold, idle for several seconds before sufficient lubrication is ensured in the turbo charger unit.

2. After high speed or extended driving that requires heavy engine load, idle the engine about one minute before turning the engine off.

This idle time will allow the turbocharger to cool prior to shutting the engine off.

### NOTICE

Do not turn off the engine immediately after it has been subjected to a heavy load. Doing so may cause severe damage to the engine or turbo charger unit.

### NOTICE

To prevent damage to the vehicle:

- If the engine stalls whilst you are in motion, do not attempt to move the shift lever to the P (Park) position.

If traffic and road conditions permit, you may put the shift lever in the N (Neutral) position whilst the vehicle is still moving and press the Engine Start/Stop button in an attempt to restart the engine.

- Do not push or tow your vehicle to start the engine.
- 

### NOTICE

To prevent damage to the vehicle:

Do not press the Engine Start/Stop button for more than 10 seconds except when the stop light fuse is blown.

When the brake switch fuse is blown, you can't start the engine normally. Replace the fuse with a new one. If you are not able to replace the fuse, you can start the engine by pressing and holding the Engine Start/Stop button for 10 seconds with the Engine Start/ Stop button in the ACC position.

For your safety, always depress the brake pedal before starting the engine.

---



### *i* Information

If the smart key battery is weak or the smart key does not work correctly, you can start the engine by pressing the Engine Start/Stop button with the smart key in the direction of the picture above.



---

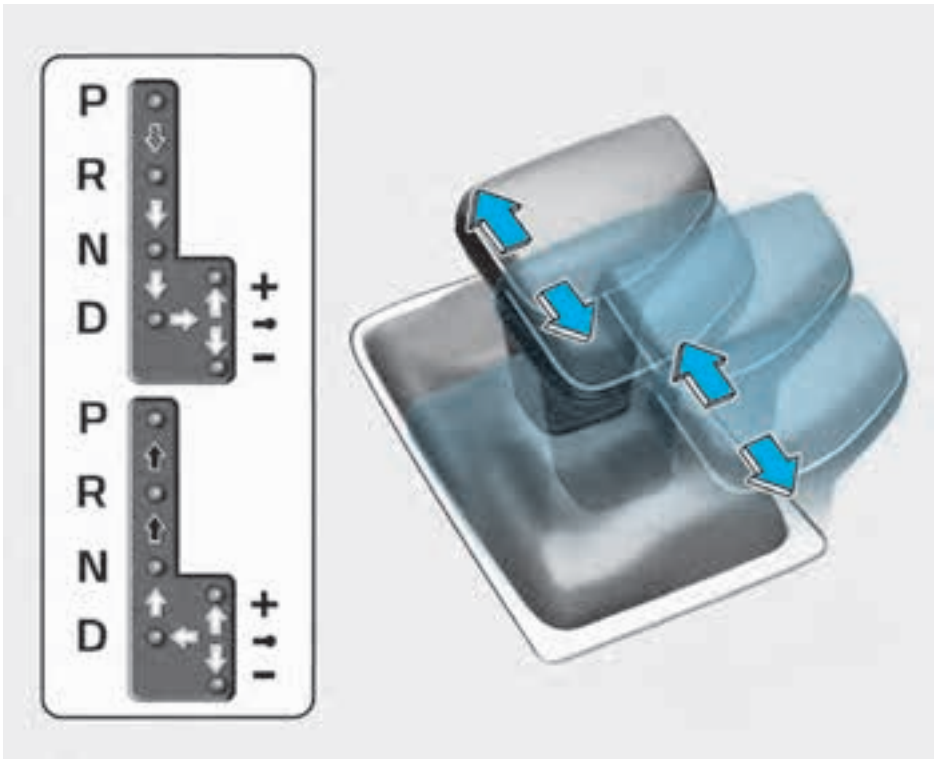

## Automatic transmission

 if equipped



- : Depress the brake pedal, press the shift button ahead of the shift lever, and then move shift lever.
- : Press the shift button, then move shift lever.
- : Move shift lever.

Depress the brake pedal whenever rotating the gear shift dial or shifting to P.

## Automatic transmission operation

The automatic transmission has six forward speeds and one reverse speed.

The individual speeds are selected automatically in the D (Drive) position.

The indicator on the instrument cluster displays the shift position when the ignition switch is in the ON position.

### WARNING

To reduce the risk of serious injury or death:

- ALWAYS check the surrounding areas near your vehicle for people, especially children, before shifting a vehicle into D (Drive) or R (Reverse).
  - Before leaving the driver's seat, always make sure the vehicle is shifted to the P (Park) position, then apply the parking brake, then move the ignition switch to the OFF position. Unexpected and sudden vehicle movement can occur if these precautions are not followed.
  - Do not use engine braking (shifting from a high gear to lower gear) rapidly on slippery roads. The vehicle may slip causing an accident.
- 

## Transmission ranges

### P (Park)

Always come to a complete stop before shifting into P (Park).

To shift from P (Park), you must depress firmly on the brake pedal and make sure your foot is off the accelerator pedal.

The shift lever must be in P (Park) before turning the engine off.

### WARNING

- Shifting into P (Park) whilst the vehicle is in motion may cause you to lose control of the vehicle.
  - After the vehicle has stopped, always make sure the vehicle is in P (Park), apply the parking brake, and turn the engine off.
  - When parking on an incline, shift the gear to P (Park) and apply the parking brake to prevent the vehicle from rolling downhill.
- 

### R (Reverse)

Use this position to drive the vehicle rearward.

### NOTICE

Always come to a complete stop before shifting into or out of R (Reverse) to prevent damaging the transmission.

---

### N (Neutral)

The wheels and transmission are not engaged.

Use N (Neutral) if you need to restart a stalled engine, or if it is necessary to stop with the engine running. Shift into P (Park) if you need to leave your vehicle for any reason.

Always depress the brake pedal when you are shifting from N (Neutral) to another gear.

### WARNING

Do not shift into gear unless your foot is firmly on the brake pedal. Shifting into gear when the engine is running at high speed can cause the vehicle to move very rapidly. You could lose control of the vehicle and hit people or objects.

---

### D (Drive)

This is the normal driving position.

The transmission automatically shifts through an 6 gear sequence, providing the best fuel economy and power.

For extra power when passing another vehicle or driving uphill, depress the accelerator pedal further until you feel the transmission downshift to a lower gear.

The DRIVE MODE switch, located on the shift lever console, allows the driver to switch from COMFORT mode to, SPORT or ECO mode. (if equipped)

For more information, refer to the "Drive mode integrated control system" section later in this chapter.

#### NOTICE

Always come to a complete stop before shifting into D (Drive).

#### CAUTION

When you start after stopping on a steep incline, even if the gear is in D (Drive), if you do not depress the accelerator or brake pedal, the vehicle may roll backwards, which can cause an accident.

### Manual shift mode



Whether the vehicle is stationary or in motion, manual shift mode is selected by pulling the shift lever from the D (Drive) position into the manual gate. To return to D (Drive) range operation, push the shift lever back into the main gate.

In Manual shift mode, moving the shift lever backwards and forwards allow you to select the desired range of gears for the current driving conditions.

+ (Up): Push the lever forward once to shift up one gear.

- (Down): Pull the lever backwards once to shift down one gear.

#### i Information

- Only the six forward gears can be selected in Manual shift mode. To reverse or park the vehicle, move the shift lever to the R (Reverse) or P (Park) position as required.
- Downshifts are made automatically when the vehicle slows down. When the vehicle stops, 1st gear is automatically selected.
- When the engine RPM approaches the red zone the transmission upshifts automatically.

### Shift-lock system

For your safety, the automatic transmission has a shift-lock system which prevents shifting the transmission from P (Park) into R (Reverse) or D (Drive) unless the brake pedal is depressed.

To shift from P (Park) or N (Neutral) into R (Reverse) or D (Drive):

1. Depress and hold the brake pedal.
2. Start the engine.
3. Shift the gear whilst depressing the brake pedal.

### Parking

Always come to a complete stop and continue to depress the brake pedal.

Shift the gear to P (Park), apply the parking brake, and move the ignition switch to turn the vehicle off.

Take the Smart Key with you when leaving the vehicle.

### WARNING

- When you stay in the vehicle with the engine running, be careful not to depress the accelerator pedal for a long period of time. The engine or exhaust system may overheat and start a fire.
  - The exhaust gas and the exhaust system are very hot. Keep away from the exhaust system components.
  - Do not stop or park over flammable materials, such as dry grass, paper or leaves. They may ignite and cause a fire.
- 

### Paddle shifter (manual shift mode)



The paddle shifter is available when the gear is in the D (Drive) position.

Pull the [+] or [-] paddle shifter once to shift up or down one gear and the system changes from automatic shift mode to manual shift mode.

To change back to automatic shift mode from manual shift mode, do one of the followings:

- Pull and hold the [+] paddle shifter.
- Shift the gear to D (Drive).

The manual shift mode also changes back to automatic shift mode in one of following situations:

- When the accelerator pedal is gently depressed for more than 6 seconds whilst driving.
- When the vehicle speed decreases below 7 km/h (4 mph).

### Information

If the [+] and [-] paddle shifters are pulled at the same time, gear shift may not occur.

---

## Good driving practices

- Never shift the gear from P (Park) or N (Neutral) to any other position with the accelerator pedal depressed.
- Never shift the gear into P (Park) when the vehicle is in motion.  
Be sure the vehicle is completely stopped before you attempt to shift into R (Reverse) or D (Drive).

- Do not shift the gear to N (Neutral) when driving. If the gear is shifted to N (Neutral) whilst driving, the vehicle loses the ability to provide engine braking. Doing so may increase the risk of an accident.

Also, shifting the gear back to D (Drive) whilst the vehicle is moving may severely damage the transmission.



- When driving uphill or downhill, always shift to D (Drive) for driving forward or shift to R (Reverse) for driving rearwards. After selecting D (Drive) or R (Reverse), check the gear position indicated on the cluster before driving. If the vehicle moves in the opposite direction of the selected gear, the engine may turn off and a serious accident might occur due to degraded brake performance.

- Do not drive with your foot resting on the brake pedal. Even light, but consistent pedal pressure can result in the brakes overheating, brake wear and possibly even brake failure.
- When driving in sport mode, slow down before shifting to a lower gear. Otherwise, the lower gear may not be engaged if the engine RPMs are outside of the allowable range.
- Always apply the parking brake when leaving the vehicle. Do not depend on placing the transmission in P (Park) to keep the vehicle from moving.
- Exercise extreme caution when driving on a slippery surface. Be especially careful when braking, accelerating or shifting gears. On a slippery surface, an abrupt change in vehicle speed can cause the drive wheels to lose traction and may cause loss of vehicle control resulting in an accident.
- Optimum vehicle performance and economy is obtained by smoothly depressing and releasing the accelerator.

## Manual transmission

 if equipped



- : The shift lever can be moved without pressing the button (1).
- : The button (1) must be pressed whilst moving the shift lever.

### Manual transmission operation

The manual transmission has 6 forward gears. The transmission is fully synchronized in all forward gears so shifting to either a higher or a lower gear is easily accomplished.

#### **WARNING**

Before leaving the driver's seat, always make sure the shift lever is in 1st gear when the vehicle is parked on an uphill and in R (Reverse) on a downhill, set the parking brake, and place the Engine Start/Stop button in the OFF position. Unexpected vehicle movement may occur if these precautions are not followed.

To shift to R (Reverse), make sure the vehicle has completely stopped, and then move the shift lever to neutral before moving into R (Reverse).

When you have come to a complete stop and it's hard to shift into 1st gear or R (Reverse):

1. Put the shift lever in neutral and release the clutch pedal.
2. Depress the clutch pedal, and then shift into 1st gear or R (Reverse).

#### **Information**

During cold weather, shifting may be difficult until the transmission lubricant has warmed up.

### **Using the clutch**

The clutch pedal should be depressed all the way to the floor before:

- Starting the engine: The engine is not start without depressing the clutch pedal.
- Shifting the gear: up shifting to the next higher gear, or down shifting to the next lower gear.

When releasing the clutch pedal, release it slowly. The clutch pedal should always be released whilst driving.

#### **CAUTION**

To start or reverse the vehicle, release the clutch pedal slowly after shifting the gear. Sudden release of the clutch pedal may result in an abrupt accident.

**NOTICE**

To prevent unnecessary wear or damage to the clutch:

- Do not rest your foot on the clutch pedal whilst driving.
- Do not hold the vehicle with the clutch on an incline, whilst waiting for the traffic light, etc.
- Always depress the clutch pedal down fully to prevent noise or damage.
- Do not repeatedly depress the clutch pedal before the clutch pedal returns back to its original place when released.
- Do not start with the 2nd gear engaged except when you start on a slippery road.
- Do not drive with cargo loaded more than required loading capacity.

**Downshifting**

Downshift when you must slow down in heavy traffic or drive up a steep hill, to prevent engine load.

Also, downshifting reduces the chance of stalling and helps to accelerate when you need to increase your speed again.

When the vehicle is going downhill, downshifting helps maintain safe speed by providing brake power from the engine and results in less wear on the brakes.

**NOTICE**

To prevent damage to the engine, clutch and transmission:

- When downshifting from 5th gear to 4th gear, be careful not to inadvertently push the shift lever sideways engaging the 2nd gear. A drastic downshift may cause the engine speed to increase to the point the tachometer enters the red zone and may cause engine, clutch and the transmission damage.
- Do not downshift more than two gears at a time or downshift the gear when the engine is running at high speed (5,000 RPM or higher). Such a downshifting may damage the engine, clutch and the transmission.

**Good driving practices**

- Never take the vehicle out of gear and coast down a hill. This is extremely dangerous.
- Don't "ride" the brakes. This can cause the brakes and related parts to overheat and malfunction.

When you are driving down a long hill, slow down and shift to a lower gear. Engine braking helps slow down the vehicle.

- Slow down before shifting to a lower gear. This helps avoid over-revving the engine, which can cause damage.
- Slow down when you encounter cross winds. This gives you much better control of your vehicle.
- Be sure the vehicle is completely stopped before you shift into R (Reverse) to prevent damage to the transmission.

- Exercise extreme caution when driving on a slippery surface. Be especially careful when braking, accelerating or shifting gears. On a slippery surface, an abrupt change in vehicle speed can cause the drive wheels to lose traction and may cause loss of vehicle control resulting in an accident.

### **WARNING**

Do not use aggressive engine braking (shifting from a higher gear to a lower gear) on slippery roads. This could cause the tyres to slip and may result in an accident.

---

### **WARNING**

To reduce the risk of **SERIOUS INJURY** or **DEATH**:

- ALWAYS wear your seat belt. In a collision, an unbelted occupant is significantly more likely to be seriously injured or killed than a properly belted occupant.
  - Avoid high speeds when cornering or turning.
  - Do not make quick steering wheel movements, such as sharp lane changes or fast, sharp turns.
  - The risk of rollover is greatly increased if you lose control of your vehicle at highway speeds.
  - Loss of control often occurs if two or more wheels drop off the roadway and the driver over steers to reenter the roadway.
  - In the event your vehicle leaves the roadway, do not steer sharply. Instead, slow down before pulling back into the travel lanes.
- 

## Intelligent Variable Transmission

 if equipped

The Intelligent variable transmission has no actual fixed gears. The varying gear ratios are selected automatically, depending on the position of the shift lever, vehicle's speed and position of the accelerator pedal.

### **WARNING**



To reduce the risk of serious injury or death:

- ALWAYS check the surrounding areas near your vehicle for people, especially children, before shifting a vehicle into D (Drive) or R (Reverse).
  - Before leaving the driver's seat, always make sure the vehicle is shifted to the P (Park) position, then apply the parking brake, then place the ignition switch to the LOCK/OFF position. Unexpected and sudden vehicle movement can occur if these precautions are not followed.
  - Do not use engine braking (shifting from a high gear to lower gear) rapidly on slippery roads. The vehicle may slip causing an accident.
-

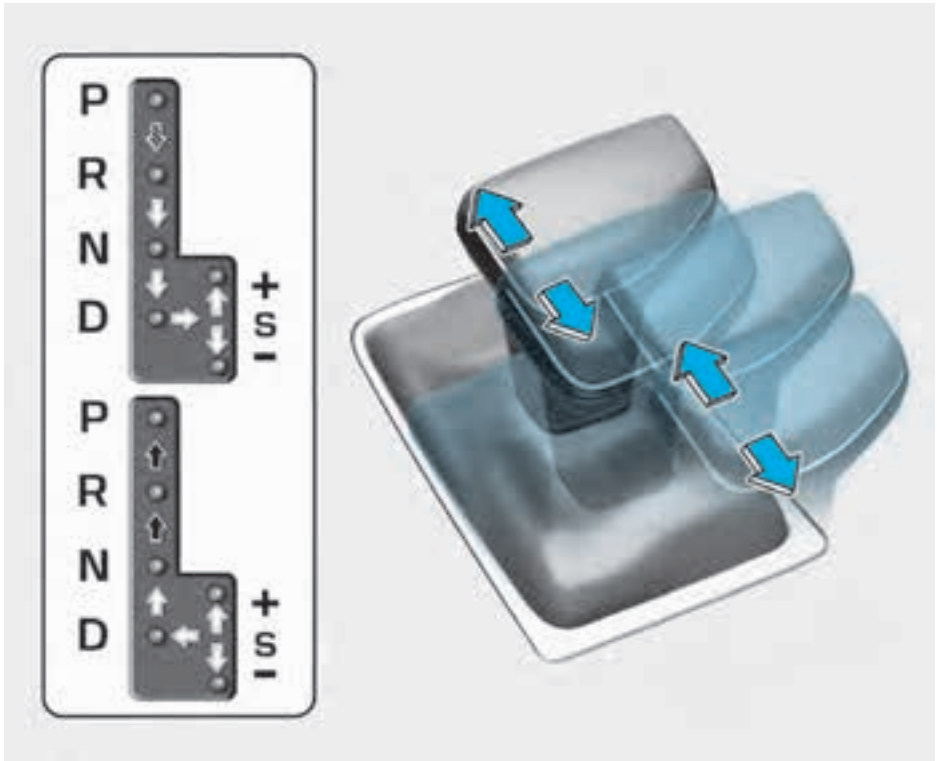

## Intelligent Variable Transmission (Shift lever type)



-  : Depress the brake pedal, press the shift button ahead of the shift lever, and then move shift lever.
-  : Press the shift button, then move shift lever.
-  : Move shift lever.

### ***Intelligent Variable Transmission (Shift lever type) operation***

The indicator in the cluster displays the shift lever position when the ignition switch is in the ON position.

#### **P (Park)**

Always come to a complete stop before shifting into P (Park).

The shift lever must be in P (Park) before turning the engine off.

#### **WARNING**

- Shifting into P (Park) whilst the vehicle is in motion may cause you to lose control of the vehicle.
  - After the vehicle has stopped, always make sure the shift lever is in P (Park), apply the parking brake, and turn the engine off.
  - Do not use the P (Park) position in place of the parking brake.
- 

#### **Information**

The engine RPM may increase or decrease when performing the IVT self-diagnosis.

---

#### **R (Reverse)**

Use this position to drive the vehicle backward.

#### **NOTICE**

Always come to a complete stop before shifting into or out of R (Reverse). You may damage the transmission if you shift into R (Reverse) whilst the vehicle is in motion.

---

#### **N (Neutral)**

The wheels and transmission are not engaged.

Use N (Neutral) if you need to restart a stalled engine, or if it is necessary to stop with the engine running. Shift into P (Park) if you need to leave your vehicle for any reason.

Always depress the brake pedal when you are shifting from N (Neutral) to another gear.

#### **WARNING**

Do not shift into gear unless your foot is firmly on the brake pedal. Shifting into gear when the engine is running at high speed can cause the vehicle to move very rapidly. You could lose control of the vehicle and hit people or objects.

---

### D (Drive)

This is the normal forward driving position. The transmission automatically shifts to the optimal gear ratio, providing better fuel efficiency and a smoother ride.

For extra power when passing another vehicle or driving uphill, depress the accelerator further until you feel the transmission downshift to a lower gear.

The DRIVE MODE switch, located on the shift lever console, allows the driver to switch from COMFORT mode to, SPORT or ECO mode. (if equipped)

For more information, refer to the "Drive mode integrated control system" section later in this chapter.

### Manual shift mode



Whether the vehicle is stationary or in motion, manual shift mode is selected by pulling the shift lever from the D (Drive) position into the manual gate. To return to D (Drive) range operation, push the shift lever back into the main gate.

In Manual shift mode, moving the shift lever backwards and forwards allow you to select the desired range of gears for the current driving conditions.

+ (Up): Push the lever forward once to shift up one gear.

- (Down): Pull the lever backwards once to shift down one gear.

### *i* Information

- Only the eight forward gears can be selected in Manual shift mode. To reverse or park the vehicle, move the shift lever to the R (Reverse) or P (Park) position as required.
- Downshifts are made automatically when the vehicle slows down. When the vehicle stops, 1st gear is automatically selected.
- When the engine RPM approaches the red zone the transmission upshifts automatically.

### Shift-lock system

For your safety, the intelligent variable transmission has a shift-lock system which prevents shifting the transmission from P (Park) into R (Reverse) unless the brake pedal is depressed.

To shift the transmission from P (Park) into R (Reverse):

1. Depress and hold the brake pedal.
2. Start the engine or place the ignition switch in the ON position.
3. Move the shift lever.

## IVT warning messages

### **Transmission high temperature**

If the warning messages on the cluster continues to blink, we recommend that you contact a HYUNDAI authorised repairer.



- Under certain conditions, such as repeated stop-and go launches on steep grades, sudden take off or acceleration, or other harsh driving conditions, the transmission clutch temperatures will increase excessively. Finally the clutch in transmission could be overheated.
- When the clutch is overheated, the safe protection mode engages and the gear position indicator on the instrument cluster blinks with a chime. At this time, 'Transmission temperature is high! Stop safely' warning message will appear on the cluster display and driving may not be smooth.
- If this occurs, pull over to a safe location, stop the vehicle with the engine running, apply the brakes and shift the vehicle to P (Park), and allow the transmission to cool.

- If you ignore this warning, the driving condition may become worse. You may experience abrupt shifts, or jerkiness. To return to the normal driving condition, stop the vehicle and apply the foot brake or shift into P(Park). Then allow the transmission to cool for a few minutes with engine on, before driving off.
- When possible, drive the vehicle smoothly.

### **Transmission overheated**

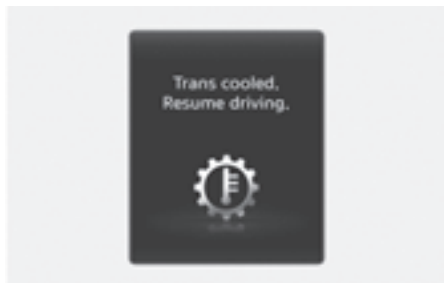

- If the vehicle continues to be driven and the clutch temperatures reach the maximum temperature limit, the 'Transmission Hot! Park with engine on' warning will be displayed. When this occurs the clutch is disabled until the clutch cools to normal temperatures.
- The warning will display a time to wait for the transmission to cool.

- If this occurs, pull over to a safe location, stop the vehicle with the engine running, apply the brakes and shift the vehicle to P (Park), and allow the transmission to cool.
- If the transmission continues to overheat and the maximum temperature is reached, the 'Vehicle Power limited due to high transmission temperature' warning will be displayed. If this occurs, shift the vehicle to P (Park) and drive the vehicle smoothly.
- When the message 'Trans cooled. Resume driving' appears you can continue to drive your vehicle.
- When possible, drive the vehicles smoothly.

If any of the warning messages in the cluster display continue to blink, for your safety, we recommend that you contact an authorised HYUNDAI dealer and have the system inspected.

## Parking

Always come to a complete stop and continue to depress the brake pedal. Shift the gear into the P (Park) position, apply the parking brake, and place the ignition switch in the LOCK/OFF position. Take the key with you when exiting the vehicle.

### WARNING

When you stay in the vehicle with the engine running, be careful not to depress the accelerator pedal for a long period of time. The engine or exhaust system may overheat and start a fire.

The exhaust gas and the exhaust system are very hot. Keep away from the exhaust system components.

Do not stop or park over flammable materials, such as dry grass, paper or leaves. They may ignite and cause a fire.

## Good driving practices

- Never shift the gear from P (Park) or N (Neutral) to any other position with the accelerator pedal depressed.
- Never shift the gear into P (Park) when the vehicle is in motion.  
Make sure the vehicle is completely stopped before you attempt to shift into R (Reverse) or D (Drive).
- Do not shift the gear to N (Neutral) when driving. Doing so may result in an accident because of a loss of engine braking and the transmission could be damaged.
- Driving uphill or downhill, always shift to D (Drive) when driving forward or to R (Reverse) when driving backwards, and check the gear position indicated on the cluster before driving. If you drive in the opposite direction of the selected gear, the engine turns off and a serious accident might be occurred due to the degraded brake performance.

- Do not drive with your foot resting on the brake pedal. Even light, but consistent pedal pressure can result in the brakes overheating, brake wear and possibly even brake failure.
- Depressing both accelerator and brake pedals at the same time can trigger logic for engine power reduction to assure vehicle deceleration. Vehicle acceleration resumes after the brake pedal is released.
- When driving in Manual shift mode, slow down before shifting to a lower gear. Otherwise, the lower gear may not be engaged if the engine RPMs are outside of the allowable range.
- Always apply the parking brake when leaving the vehicle. Do not depend on placing the transmission in P (Park) to keep the vehicle from moving.
- Exercise extreme caution when driving on a slippery surface. Be especially careful when braking, accelerating or shifting gears. On a slippery surface, an abrupt change in vehicle speed can cause the drive wheels to lose traction and may cause loss of vehicle control resulting in an accident.
- Optimum vehicle performance and economy is obtained by smoothly depressing and releasing the accelerator.

### **WARNING**

To reduce the risk of serious injury or death:

- ALWAYS wear your seatbelt. In a collision, an unbelted occupant is significantly more likely to be seriously injured or killed than a properly belted occupant.
  - Avoid high speeds when cornering or turning.
  - Do not make quick steering wheel movements, such as sharp lane changes or fast, sharp turns.
  - The risk of rollover is greatly increased if you lose control of your vehicle at highway speeds.
  - Loss of control often occurs if two or more wheels drop off the roadway and the driver over steers to reenter the roadway.
  - In the event your vehicle leaves the roadway, do not steer sharply. Instead, slow down before pulling back into the travel lanes.
-

## Dual clutch Transmission

**+** if equipped

The dual clutch transmission has seven forward speeds and one reverse speed. The individual speeds are selected automatically when the shift lever is in the D (Drive) position.

- The dual clutch transmission can be thought of as an automatically shifting manual transmission. It gives the driving feel of a manual transmission, yet provides the ease of a fully automatic transmission.
- When D (Drive) is selected, the transmission automatically shifts through the gears similar to a conventional automatic transmission. Unlike a traditional automatic transmission, the gear shifting can sometimes be felt and heard as the actuators engage the clutches and the gears are selected.
- The dual clutch transmission incorporates a dry-type dual clutch mechanism, which allows for better acceleration performance and increased fuel efficiency whilst driving. But it differs from a conventional automatic transmission because it does not incorporate a torque converter. Instead, the transition from one gear to the next is managed by clutch slip, especially at lower speeds.

As a result, shifts are sometimes more noticeable, and a light vibration can be felt as the transmission shaft speed is matched with the engine shaft speed. This is a normal condition of the dual clutch transmission.

- The dry-type clutch transfers torque more directly and provides a direct drive feeling which may feel different from a conventional automatic transmission. This may be more noticeable when launching the vehicle from a stop or when travelling at low, stop-and-go vehicle speeds.
- When rapidly accelerating from a lower vehicle speed, the engine RPM may increase dramatically as a result of clutch slip as the dual clutch transmission selects the correct gear. This is a normal condition.
- When accelerating from a stop on an incline, press the accelerator smoothly and gradually to avoid any shudder feeling or jerkiness.
- When travelling at a lower vehicle speed, if you release the accelerator pedal quickly, you may feel engine braking before the transmission changes gears. This engine braking feeling is similar to operating a manual transmission at low speed.
- When driving downhill, you may wish to move the gear shift lever to Manual shift mode and downshift to a lower gear in order to control your speed without using the brake pedal excessively.

- When you turn the engine on and off, you may hear clicking sounds as the system goes through a self-test. This is a normal sound for the dual clutch transmission.
- During the first 1,500 km (1,000 mi.), you may feel that the vehicle may not be smooth when accelerating at low speed. During this break-in period, the shift quality and performance of your new vehicle is continuously optimized.



### WARNING



To reduce the risk of serious injury or death:

- Always check the surrounding areas near your vehicle for people, especially children, before shifting a vehicle into D (Drive) or R (Reverse).
  - Before leaving the driver's seat, always make sure the shift button is in the P (Park) position, then set the parking brake, and press the Engine Start/Stop button to the OFF position. Unexpected and sudden vehicle movement can occur if these precautions are not followed.
  - Do not use aggressive engine braking (shifting from a higher gear to a lower gear) on slippery roads. The vehicle may lose traction with the roadway, resulting in a collision.
-

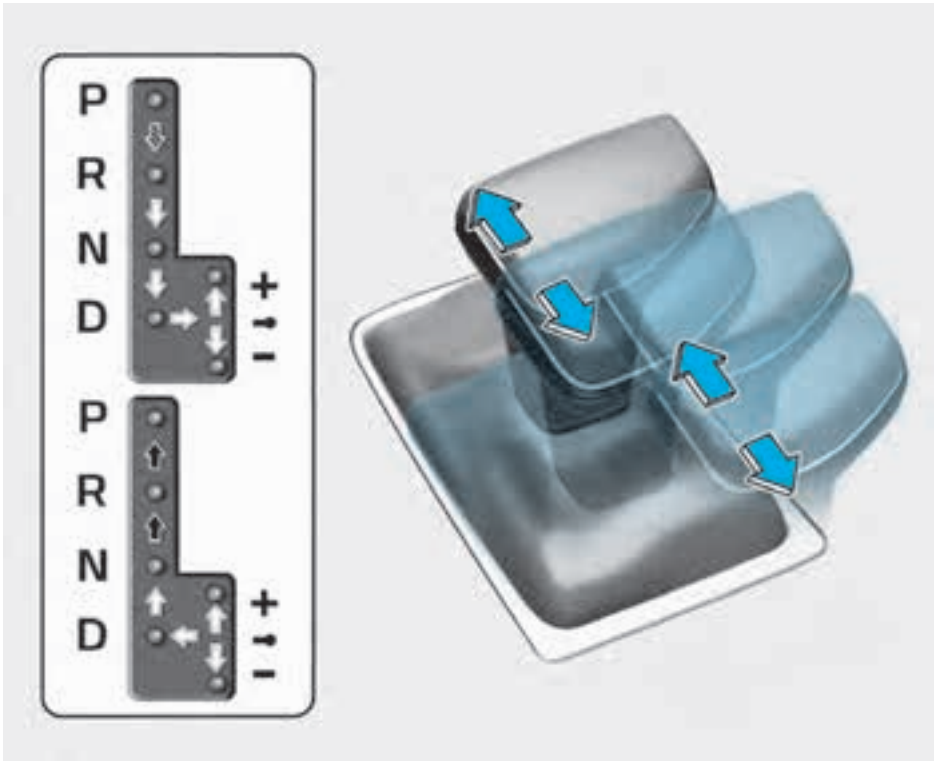

## Dual clutch Transmission



- : Depress the brake pedal, press the shift button ahead of the shift lever whilst moving the shift lever.
- : Press the shift button whilst moving the shift lever.
- : The shift lever can freely operate.

### **Dual clutch Transmission operation**

The indicator on the cluster displays the shift lever position when the ignition switch or Engine Start/Stop button is in the ON position.

#### **P (Park)**

Always come to a complete stop before shifting into P (Park).

To shift from P (Park), you must depress firmly on the brake pedal and make sure your foot is off the accelerator pedal.

The shift lever must be in P (Park) before turning the engine off.

#### **WARNING**

- Shifting into P (Park) whilst the vehicle is in motion may cause you to lose control of the vehicle.
- When parking on an incline, place the shift lever in P (Park) and apply the parking brake to prevent the vehicle from rolling downhill.
- Do not use the P (Park) position in place of the parking brake.

---

#### **R (Reverse)**

Use this position to drive the vehicle rearward.

#### **NOTICE**

Always come to a complete stop before shifting into or out of R (Reverse) to prevent damaging the transmission.

---

#### **N (Neutral)**

The wheels and transmission are not engaged.

Use N (Neutral) if you need to restart a stalled engine, or if it is necessary to stop with the engine running. Shift into P (Park) if you need to leave your vehicle for any reason.

Always depress the brake pedal when you are shifting from N (Neutral) to another gear.

#### **D (Drive)**

This is the normal driving position. The transmission automatically shifts through a 7 gear sequence, providing the best fuel economy and power.

For extra power when passing another vehicle or driving uphill, depress the accelerator fully. The transmission automatically downshifts to the next lower gear (or gears, as appropriate).

The DRIVE MODE switch, located on the shift lever console, allows the driver to switch from COMFORT mode to, SPORT or ECO mode. (if equipped)

For more information, refer to the "Drive mode integrated control system" section later in this chapter.

## Manual shift mode



Whether the vehicle is stationary or in motion, manual shift mode is selected by pulling the shift lever from the D (Drive) position into the manual gate. To return to D (Drive) range operation, push the shift lever back into the main gate.

In Manual shift mode, moving the shift lever backwards and forwards allow you to select the desired range of gears for the current driving conditions.

+ (Up): Push the lever forward once to shift up one gear.

- (Down): Pull the lever backwards once to shift down one gear.

## *i* Information

- Only the seven forward gears can be selected in Manual shift mode. To reverse or park the vehicle, move the shift lever to the R (Reverse) or P (Park) position as required.
- Downshifts are made automatically when the vehicle slows down. When the vehicle stops, 1st gear is automatically selected.
- When the engine RPM approaches the red zone the transmission upshifts automatically.
- If the driver presses the lever to + (Up) or - (Down) position, the transmission may not make the requested gear change if the next gear is outside of the allowable engine RPM range. The driver must execute upshifts in accordance with road conditions, taking care to keep the engine RPMs below the red zone.

### Shift-lock system

For your safety, the dual clutch transmission has a shift-lock system which prevents shifting the transmission from P (Park) into R (Reverse) unless the brake pedal is depressed.

To shift the transmission from P (Park) into R (Reverse):

1. Depress and hold the brake pedal.
2. Start the engine or place the ignition switch or Engine Start/Stop button in the ON position.
3. Depress the brake pedal and put the gear in R.

## Paddle shifter (manual shift mode)



The paddle shifter is available when the gear is in the D (Drive) position.

Pull the [+] or [-] paddle shifter once to shift up or down one gear and the system changes from automatic shift mode to manual shift mode.

To change back to automatic shift mode from manual shift mode, do one of the followings:

- Pull and hold the [+] paddle shifter.
- Shift the gear to D (Drive).

The manual shift mode also changes back to automatic shift mode in one of following situations:

- When the accelerator pedal is gently depressed for more than 6 seconds whilst driving.
- When the vehicle speed decreases below 7 km/h (4 mph).

### **i** Information

If the [+] and [-] paddle shifters are pulled at the same time, gear shift may not occur.

## DCT warning messages

### **Transmission overheated warning**

If the warning messages on the cluster continues to blink, we recommend that you contact a HYUNDAI authorised repairer.

### **Steep grade! Press brake pedal**

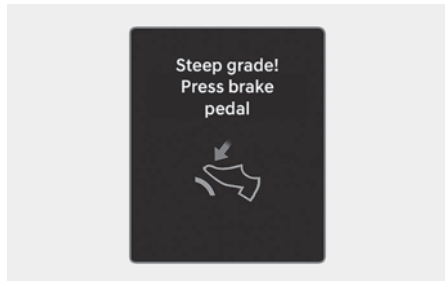

This message appears when the vehicle is driving up hills or on steep grades.

If the vehicle is held or creeping forward on an incline by applying the accelerator pedal, the clutch and transmission may result in damage.

Press the brake pedal, if the messages appears on the cluster display.

### Transmission temperature is high! Stop safely



Repeated stop-and-go launches on steep grades, sudden take off or acceleration, or other harsh driving conditions may increase the clutch and transmission temperature.

If the clutch and the transmission temperature is high, the self-protection mode warns you with a warning chime and message whilst the shift indicator on the cluster display blinks.

- Move the vehicle to a safe location and shift the gear to P (Park) with the engine running. Wait until the transmission is sufficiently cooled down.
- If you ignore this warning, you may experience abrupt shifts, frequent shifts, or jerkiness.

### Transmission hot! Park with engine On



If you continue to drive with an overheated transmission, the above warning message appears, and the self-protection mode disables the clutch.

- Move the vehicle to a safe location and shift the gear to P (Park) with the engine running. Wait until the transmission is sufficiently cooled down.
- If the above warning message is displayed continuously, we recommend that you contact a HYUNDAI authorised repairer.

### Cooling... Remain parked for 00 min.

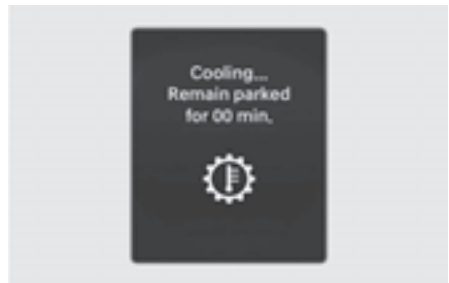

If you move the vehicle to a safe location and shift the gear to P (Park) with the engine running, the above warning message appears.

- Wait until the clutch is sufficiently cooled down.

### Transmission cooled down. Resume driving

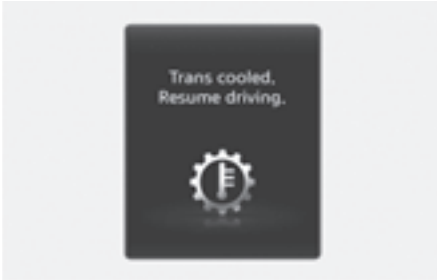

This message appears when your vehicle can be driven.

Drive the vehicle smoothly as possible.

### Parking

Always come to a complete stop and continue to depress the brake pedal. Shift the gear into the P (Park) position, apply the parking brake, and press the Engine Start/Stop button to the OFF position. Take the key with you when exiting the vehicle.

### Good driving practices

- Never shift the gear from P (Park) or N (Neutral) to any other position with the accelerator pedal depressed.
- Never shift the gear into P (Park) when the vehicle is in motion.  
Be sure the vehicle is completely stopped before you attempt to shift into R (Reverse) or D (Drive).
- Do not shift the gear to N (Neutral) when driving. Doing so may result in a collision because of a loss of engine braking and the transmission could be damaged.

- Driving uphill or downhill, always shift to D (Drive) when driving forward or to R (Reverse) when driving backwards, and check the gear position indicated on the cluster before driving. If you drive in the opposite direction of the selected gear, the engine turns off and a serious accident might be occurred due to the degraded brake performance.
- Do not drive with your foot resting on the brake pedal. Even light, but consistent pedal pressure can result in the brakes overheating, brake wear and possibly even brake failure.
- Depressing both accelerator and brake pedals at the same time can trigger logic for engine power reduction to assure vehicle deceleration. Vehicle acceleration resumes after the brake pedal is released.
- When driving in Manual shift mode, slow down before shifting to a lower gear. Otherwise, the lower gear may not be engaged if the engine RPMs are outside of the allowable range.
- When driving with paddle shifters, slow down before shifting to a lower gear. Otherwise, the lower gear may not be engaged if the engine RPMs are outside of the allowable range.
- Always apply the parking brake when leaving the vehicle. Do not depend on placing the transmission in P (Park) to keep the vehicle from moving.
- Exercise extreme caution when driving on a slippery surface. Be especially careful when braking, accelerating or shifting gears. On a slippery surface, an abrupt change in vehicle speed can cause the drive wheels to lose traction and may cause loss of vehicle control resulting in a collision.
- Optimum vehicle performance and economy is obtained by smoothly depressing and releasing the accelerator.

## WARNING

To reduce the risk of serious injury or death:

- ALWAYS wear your seatbelt. In a collision, an unbelted occupant is significantly more likely to be seriously injured or killed than a properly belted occupant.
  - Avoid high speeds when cornering or turning.
  - Do not make quick steering wheel movements, such as sharp lane changes or fast, sharp turns.
  - The risk of rollover is greatly increased if you lose control of your vehicle at highway speeds.
  - Loss of control often occurs if two or more wheels drop off the roadway and the driver over steers to reenter the roadway.
  - In the event your vehicle leaves the roadway, do not steer sharply. Instead, slow down before pulling back into the travel lanes.
  - HYUNDAI recommends you follow all posted speed limits.
- 

## Braking system

### Power-assist brakes

Your vehicle has power-assisted brakes that adjust automatically through normal usage.

If the engine is not running or is turned off whilst driving, the power assist for the brakes does not work. You can still stop your vehicle by applying greater force to the brake pedal than typical. The stopping distance, however, may be longer than with power brakes.

When the engine is not running, the reserve brake power is partially depleted each time the brake pedal is applied. Do not pump the brake pedal when the power assist has been interrupted.

### *i* Information

- When the brake pedal is depressed under certain driving conditions or weather conditions, you may temporarily hear a noise. This is normal and does not indicate a problem with your brakes.
  - Whilst driving on a road with deicing chemicals, brake noise or abnormal tyre wear may occur due to deicing chemicals. In a safe traffic condition, additionally apply the brakes to remove deicing chemicals on the brake discs and pads.
-

**! WARNING**

Take the following precautions:

- Do not drive with your foot resting on the brake pedal. This will create abnormal high brake temperatures, excessive brake lining and pad wear, and increased stopping distances.
- When descending down a long or steep hill, use the paddle shifter and manually downshift to a lower gear in order to control your speed without using the brake pedal excessively. Applying the brakes continuously will cause the brakes to overheat and may result in a temporary loss of braking performance.
- Wet brakes may impair the vehicle's ability to safely slow down and the vehicle may also pull to one side when the brakes are applied. Applying the brakes lightly indicates whether they have been affected in this way. Always test your brakes in this fashion after driving through deep water. To dry the brakes, lightly tap the brake pedal to heat up the brakes whilst maintaining a safe forward speed until brake performance returns to normal. Avoid driving at high speeds until the brakes function correctly.

### Disc brakes wear indicator

When your brake pads are worn and new pads are required, you may hear a high pitched warning sound from your front or rear brakes. You may hear this sound come and go or it may occur whenever you depress the brake pedal.

**i Information**

Always replace both the left and right brake pads on the front and rear axles at the same time.

### Rear drum brakes

Your rear drum brakes do not have wear indicators. Therefore, have the rear brake linings inspected if you hear a rear brake rubbing noise. Also have your rear brakes inspected each time you change or rotate your tyres and when you have the front brakes replaced.

### Parking brake (hand type)

**+ if equipped**



Always set the parking brake before leaving the vehicle, to apply:

Firmly depress the brake pedal. Pull up the parking brake lever as far as possible.

**! WARNING**

To reduce the risk of **SERIOUS INJURY** or **DEATH**, do not operate the parking brake whilst the vehicle is moving except in an emergency situation. It could damage the brake system and lead to an accident.



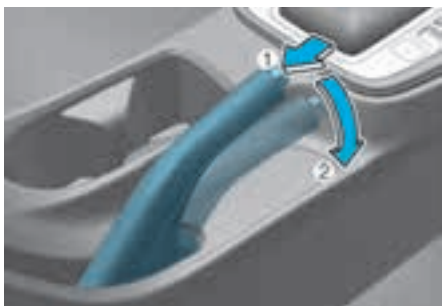

To release:

Firmly depress the brake pedal. Slightly pull up the parking brake lever.

whilst pressing the release button (1), lower the parking brake (2).

If the parking brake does not release or does not release all the way, we recommend that the system be checked by an authorised HYUNDAI dealer.

### **WARNING**

- Whenever leaving the vehicle or parking, always come to a complete stop and continue to depress the brake pedal. Move the shift lever into the 1st gear (for Manual transmission vehicle) or P (Park, for Intelligent Variable Transmission/Automatic Transmission vehicle) position, then apply the parking brake, and place the ignition switch in the LOCK/OFF position. Vehicles with the parking brake not fully engaged are at risk for moving inadvertently and causing injury to yourself or others.
- NEVER allow anyone who is unfamiliar with the vehicle to touch the parking brake. If the parking brake is released unintentionally, serious injury may occur.
- Only release the parking brake when you are seated inside the vehicle with your foot firmly on the brake pedal.

### **NOTICE**

- Do not apply the accelerator pedal whilst the parking brake is engaged. If you depress the accelerator pedal with the parking brake engaged, warning will sound. Damage to the parking brake may occur.
- Driving with the parking brake on can overheat the braking system and cause premature wear or damage to brake parts. Make sure the parking brake is released and the Brake Warning Light is off before driving.

### ***Parking brake warning light***



This light illuminates when the parking brake is applied with the ignition switch in the START or ON position.

Before driving, make sure the parking brake is released and the parking brake warning light is OFF.

If the parking brake warning light remains on after the parking brake is released whilst the engine is running, there may be a malfunction in the brake system.

If possible, stop driving the vehicle immediately. If that is not possible, use extreme caution whilst operating the vehicle and only continue to drive the vehicle until you can reach a safe location.

## Electronic Parking Brake (EPB)

 If equipped

### Applying the parking brake

To apply EPB (Electronic Parking Brake):



1. Depress and hold the brake pedal.
2. Pull up the EPB switch.

Make sure the Parking Brake warning light comes on.

**EPB (Electronic Parking Brake) may be automatically applied when:**

- Requested by other systems.
- The driver turns the vehicle off whilst Auto Hold is operating.

### Emergency braking

If there is a problem with the brake pedal whilst driving, emergency braking is possible by pulling up and holding the EPB switch. Braking is possible only whilst you are holding the EPB switch. However, braking distance may be longer than normal.

### WARNING

To reduce the risk of serious injury or death, do not operate the EPB whilst the vehicle is moving except in an emergency situation. It may damage the brake system and cause a collision.

## Information

During emergency braking, the Parking Brake warning light illuminates and you may hear a clicking noise.

### NOTICE

If you notice a noise or burning smell when the EPB is used for emergency braking, we recommend that your vehicle be inspected by a HYUNDAI authorised repairer.

### Releasing the parking brake

To release EPB (Electronic Parking Brake):



1. Place the ignition switch or Engine Start/Stop button to ON or START position.
2. Press the EPB switch whilst depressing the brake pedal.

Make sure the Parking Brake warning light goes off.

### To release EPB (Electronic Parking Brake) automatically:

- Gear in P (Park) or in N (Neutral)
 

With the engine running, depress the brake pedal and shift out of P (Park) or N (Neutral) to R (Reverse) or D (Drive). Make sure the doors, bonnet, and tailgate are closed and the seat belt is fastened.
- Manual transmission
  1. Ensure seat belts are fastened and the doors, hood and tailgate are closed.
  2. With the engine running, depress the clutch pedal and move the shift lever to 1(First) gear or R (Reverse).
  3. Depress the accelerator pedal whilst releasing the clutch pedal.
- Intelligent variable transmission/Automatic transmission/Dual clutch transmission
  1. Ensure seat belts are fastened and the doors, hood and tailgate are closed.
  2. With the engine running, depress the brake pedal and shift out of P (Park) to R (Reverse) or D (Drive).
  3. Depress the accelerator pedal.

Make sure the Parking brake warning light goes off.

### *i* Information

- You can engage EPB even though the ignition switch or Engine Start/Stop button is in the OFF position (only if battery power is available), but you cannot release it.
- Depress the brake pedal and release the parking brake manually with the EPB switch before you drive downhill or when backing up.

### *i* Information

#### Manual transmission

A vehicle towing a trailer on a hill or on an incline may slightly roll backwards when starting the vehicle. To prevent the situation follow the below instructions.

1. Depress the clutch pedal and select a gear.
2. Keep pulling up the EPB switch.
3. Depress the accelerator pedal and slowly release the clutch pedal.
4. If the vehicle starts off with enough driving power release the EPB switch.

Do not follow the above procedure when driving on a flat level ground. The vehicle may suddenly move forward.

### **NOTICE**

- If the Parking Brake warning light is still on even though the EPB has been released, we recommend that your vehicle be inspected by a HYUNDAI authorised repairer.
- Do not drive your vehicle with EPB applied. It may cause excessive brake pad and brake rotor wear.

## Warning messages

To release EPB, fasten seatbelt and close door, bonnet and tailgate



If the driver's seat belt is unfastened, or the bonnet, tailgate, doors are open, and you try to drive with EPB applied, a warning sounds and a message appears.

### WARNING

To prevent serious injury or death from unintended vehicle movement:

- Always come to a complete stop and continue to depress the brake pedal before parking, shift the gear into P (Park), pull up the EPB switch, and press the ignition switch or Engine Start/Stop button to the OFF position. Take the key with you when leaving the vehicle.
- Never allow anyone who is unfamiliar with the vehicle to touch the EPB switch.
- Only release EPB when you are seated inside the vehicle with your foot firmly on the brake pedal.

### NOTICE

Driving with the parking brake on may overheat the braking system and cause premature wear or damage to brake parts.

### Information

- A clicking sound may be heard whilst operating or releasing the EPB. These conditions are normal and indicate that EPB is functioning properly.
- When leaving your keys with a parking attendant or assistant, make sure to inform him/her how to operate the EPB.

## EPB malfunction

Electronic Parking Brake (EPB) warning light illuminates if the ignition switch or Engine Start/Stop button is in the ON position and goes off in about 3 seconds if the system is operating normally.

If the EPB warning light remains on, comes on whilst driving, or does not come on when the ignition switch or Engine Start/Stop button is ON, the EPB may have malfunctioned.

If this occurs, we recommend that your vehicle be inspected by a HYUNDAI authorised repairer.

The EPB warning light may illuminate when the ESC indicator comes on to indicate that ESC is not working properly, but it does not indicate a malfunction of EPB.

### Information

- If the Parking Brake warning light does not illuminate or blinks after the EPB switch has been pulled, the EPB may not be applied.
- If the EPB warning light is still on or the Parking Brake warning light blinks when the EPB warning light is on, press the switch, and then pull it up. Repeat this one more time. If the EPB warning does not go off, we recommend that your vehicle be inspected by a HYUNDAI authorised repairer.

## Auto hold

 if equipped

Auto Hold maintains the vehicle in a standstill even though the brake pedal is not depressed after the driver brings the vehicle to a complete stop by depressing the brake pedal.

### Information

When the vehicle is restarted, the last setting for Auto Hold is applied.

### To apply:



1. With the driver's door, bonnet, and tailgate closed, press the AUTO HOLD switch. The white AUTO HOLD indicator comes on and the system is in standby.
2. When you stop the vehicle completely by depressing the brake pedal, Auto Hold maintains the brake pressure to hold the vehicle stationary. The indicator changes from white to green. The vehicle remains stationary even if you release the brake pedal.

### To release:

If you depress the accelerator pedal with the gear in D (Drive) or manual shift mode or R (Reverse) (vehicle equipped with shift button), the Auto Hold is released automatically and the vehicle starts to move. The AUTO HOLD indicator changes from green to white.

### WARNING

Always look around your vehicle before depressing the accelerator pedal to release Auto Hold.

### To cancel:



1. Depress and hold the brake pedal.
  2. Press the AUTO HOLD switch.
- The AUTO HOLD indicator turns off.

### WARNING

To prevent unintended vehicle movement, always depress your foot on the brake pedal to cancel the Auto Hold before you:

- Drive downhill.
- Drive the vehicle in R (Reverse).
- Park the vehicle.

## **i** Information

The Auto Hold does not operate when:

- The driver's door or bonnet is opened.
- The tailgate is opened.
- The gear is in P (Park) or R (reverse).
- EPB is applied.
- The Auto Hold automatically switches to EPB when:
  - The driver's door or bonnet is opened.
  - The vehicle is in a standstill for more than 10 minutes.
  - The vehicle is on a steep slope.
  - The vehicle moves several times.
  - The tailgate is opened. (for rotary gear shift dial type)

The Parking Brake warning light comes on, the AUTO HOLD indicator changes from green to white, and a warning sounds and a message appears to inform you that EPB has been automatically engaged. Before driving, depress the brake pedal, check the surrounding area, and release the parking brake manually with the EPB switch.

## **NOTICE**

If the AUTO HOLD indicator changes to yellow, or the driver's door, bonnet, or tailgate open detection system malfunctions, Auto Hold does not work properly. We recommend that you contact a HYUNDAI authorised repairer.

## **NOTICE**

If there is a malfunction with the driver's door or engine bonnet open detection system, Auto Hold may not work properly.

We recommend that you contact a HYUNDAI authorised dealer.

## **Warning messages**

### **Parking brake automatically applied**

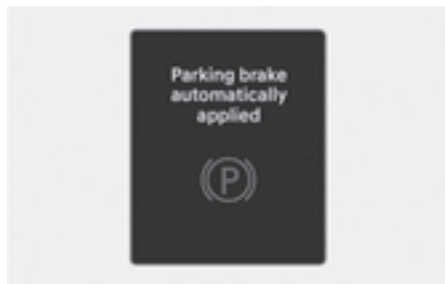

When EPB is applied whilst Auto Hold is activated, a warning sounds and a message appears.

### **Deactivating AUTO HOLD... Press brake pedal**

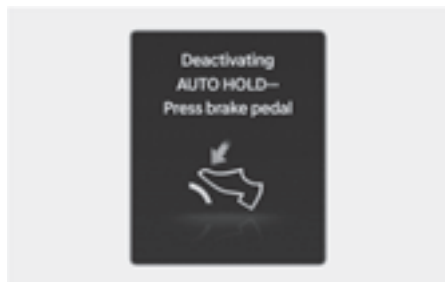

When the conversion from Auto Hold to EPB is not working properly, a warning sounds and a message appears.

### Press brake pedal to deactivate AUTO HOLD

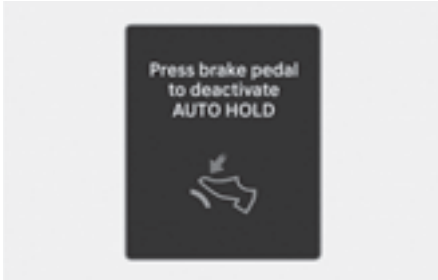

If you did not apply the brake pedal when you release Auto Hold by pressing the AUTO HOLD switch, a warning sounds and a message appears.

## Anti-Lock Braking System (ABS)

### WARNING

Anti-Lock Braking System (ABS) or Electronic Stability Control (ESC) system does not prevent accidents due to improper or dangerous driving manoeuvres. Even though vehicle control is improved during emergency braking, always maintain a safe distance between you and objects ahead of you. Always reduce the vehicle speed in extreme road conditions.

The braking distance for vehicles equipped with ABS or ESC may be longer than for those without these systems in the following road conditions:

- Rough, gravel or snow-covered roads.
- On roads where the road surface is pitted or has different surface height.
- Tyre chains are installed on your vehicle.

Never test the safety features of an ABS or ESC equipped vehicle by high speed driving or cornering. It may cause a collision and endanger the safety of yourself or others.

ABS is an electronic braking system that helps prevent a braking skid. ABS allows the driver to steer and brake at the same time.

### Using ABS

To obtain the maximum benefit from your ABS in an emergency situation, do not attempt to modulate your brake pressure and do not try to pump your brakes. Depress your brake pedal as hard as possible.

When you apply your brakes under conditions that may lock the wheels, you may hear sounds from the brakes, or feel a corresponding sensation in the brake pedal. This is normal and it means your ABS is active.

ABS does not reduce the time or distance it takes to stop the vehicle.

Always maintain a safe distance from the vehicle in front of you.

ABS does not prevent a skid that results from sudden changes in direction, such as trying to take a corner too fast or making a sudden lane change. Always drive at a safe speed for the road and weather conditions.

ABS cannot prevent a loss of stability. Always steer moderately when braking hard. Severe or sharp steering wheel movement can still cause your vehicle to veer into oncoming traffic or off the road.

On loose or uneven road surfaces, operation of the anti-lock brake system may result in a longer stopping distance than for vehicles equipped with a conventional brake system.

The ABS  warning light stays on for several seconds after the ignition switch or Engine Start/Stop button is in the ON position.

During that time, ABS goes through self-diagnosis and the light goes off if everything is normal. If the light stays on, we recommend that you contact a

HYUNDAI authorised repairer as soon as possible.

### **WARNING**

If the ABS (■) warning light is on and stays on you may have a problem with the ABS. Your power brakes work normally. To reduce the risk of serious injury or death it is recommended to contact your authorised HYUNDAI dealer as soon as possible.

---

### **NOTICE**

When you drive on a road having poor traction, such as an icy road, and apply your brakes continuously, ABS is active continuously and the ABS (■) warning light may illuminate. Pull your vehicle over to a safe place and turn off the vehicle.

Restart the vehicle. If the ABS warning light is off, then your ABS system is normal.

If not, we recommend that you contact a HYUNDAI authorised repairer as soon as possible.

---

### **Information**

When you jump start your vehicle because of a drained battery, the ABS (■) warning light may turn on at the same time. It does not mean your ABS is malfunctioning. Have the battery recharged before driving the vehicle.

---

## Electronic Stability Control (ESC)



The Electronic Stability Control (ESC) system helps stabilize the vehicle during cornering manoeuvres.

ESC checks where you are steering and where the vehicle is actually going. ESC applies braking pressure to any one of the vehicle's brakes and intervenes in the engine management system to assist the driver with keeping the vehicle on the intended path. It is not a substitute for safe driving practices. Always adjust your speed and driving to the road conditions.

### **WARNING**

Never drive too fast for the road conditions or too quickly when cornering. The ESC system does not prevent a collision.

Excessive speed in turns, abrupt manoeuvres, and hydroplaning on wet surfaces may result in severe collisions.

---



## ESC operation

### ESC ON condition

When the ignition switch or Engine Start/Stop button is in the ON position, the ESC and the ESC OFF indicator lights illuminate for about 3 seconds. After both lights go off, ESC is enabled.

### When operating



When the ESC is operating, the ESC indicator light blinks:

- When you apply your brakes under conditions that may lock the wheels, you may hear sounds from the brakes, or feel a corresponding sensation in the brake pedal.
- If Cruise Control has been used when ESC activates, Cruise Control automatically disengages. Refer to the “Cruise Control (CC)” section in Chapter 7.
- When moving out of the mud or driving on a slippery road, the engine RPM (revolutions per minute) may not increase even if you depress the accelerator pedal all the way. This is to maintain the stability and traction of the vehicle and does not indicate a problem.

### ESC OFF condition



To cancel ESC operation:

- State 1  
Press the ESC OFF button briefly. The ESC OFF indicator light and the message, “**Traction control disabled**” illuminate.  
The traction control function of ESC (engine management) is disabled, but the brake control function of ESC (braking management) still operates.
- State 2  
Press and hold the ESC OFF button continuously for more than 3 seconds. The ESC OFF indicator light and/or message “**Traction control and ESC disabled**” illuminates and a warning chime sounds. Both the traction control function of ESC (engine management) and the brake control function of ESC (braking management) are disabled.  
If the ignition switch or Engine Start/Stop button is in the OFF position when ESC is off, ESC remains off. Upon restarting the vehicle, ESC automatically turns on again.

### Indicator lights

ESC indicator light (blinks)



ESC OFF indicator light (comes on)



When the ignition switch or Engine Start/Stop button is in the ON position, the ESC indicator light illuminates, then goes off if the ESC system is operating normally.

The ESC indicator light blinks whenever ESC is operating.

If the ESC indicator light stays on, we recommend that your vehicle be inspected by a HYUNDAI authorised repairer as soon as possible.

The ESC OFF indicator light comes on when ESC is turned off.

### WARNING

When ESC is blinking, this indicates ESC is active:

- Drive slowly and NEVER attempt to accelerate.
  - Never turn off ESC whilst the ESC indicator light is blinking. You may lose control of the vehicle and collide.
- 

### NOTICE

Driving with wheels and tyres with different sizes may cause the ESC system to malfunction. Before replacing tyres, make sure all four tyres and wheels are the appropriate size for your vehicle. Never drive the vehicle with different sized wheels and tyres installed.

---

### ESC OFF usage

#### When Driving

The ESC OFF mode should only be used briefly to help free the vehicle if stuck in snow or mud, by temporarily stopping operation of ESC, to maintain wheel torque.

To turn off ESC whilst driving, press the ESC OFF button whilst driving on a flat road surface.

### NOTICE

To prevent damage to the transmission:

- Do not allow wheel(s) of one axle to spin excessively whilst the ESC, ABS, and Parking Brake warning lights appear. The repairs would not be covered by the vehicle warranty. Reduce engine power and do not spin the wheel(s) excessively whilst these lights appear.
  - When operating the vehicle on a dynamometer, make sure ESC is turned off (ESC OFF light illuminated).
- 

### Information

Turning ESC off does not affect ABS or standard brake system operation.

---

## Vehicle Stability Management (VSM)

Vehicle Stability Management is a function of the Electronic Stability Control (ESC) system. It helps the vehicle stay stable when accelerating or braking suddenly on wet, slippery and rough roads where traction over the four tyres can suddenly become uneven.

### WARNING

VSM is not a substitute for safe driving practices. To prevent serious injury or death:

- Always monitor the speed and the distance to the vehicle ahead of you.
- Never drive too fast for the road conditions. Excessive speed in bad weather or on slippery and uneven roads may result in severe collisions.

### VSM operation

#### When operating

When you apply your brakes under conditions that can activate ESC, you may hear sounds from the brakes, or feel a corresponding sensation in the brake pedal. This is normal and it means your VSM is active.

### Information

VSM does not operate when:



- Driving on a banked road such as gradient or incline.
- Driving in reverse.
- The ESC OFF indicator light is on.
- The MDPS (Motor Driven Power Steering) warning light () is on or blinks.

### VSM OFF condition

To cancel VSM operation, press the ESC OFF button. ESC OFF () indicator light illuminates.

To turn on VSM again, press the ESC OFF button again. The ESC OFF indicator light goes out.

### WARNING

If the ESC () indicator light or MDPS () warning light stays illuminated or blinks, your vehicle may have a malfunction with the VSM system. When the warning light illuminates, we recommend that your vehicle be inspected by a HYUNDAI authorised repairer as soon as possible.

## Hill-Start Assist Control (HAC)

Hill-Start Assist Control helps prevent the vehicle from rolling backwards when starting from a stop on a hill.

### WARNING

Always be ready to depress the accelerator pedal when starting from a stop on an uphill slope. Hill-Start Assist Control activates only for about 2 seconds.

### Information

- Hill-Start Assist Control does not operate when the gear is shifted to P (Park) or N (Neutral).
- Hill-Start Assist Control activates even when the ESC (Electronic Stability Control) is off. It does not activate, if the ESC is not operating normally.

## Emergency Stop Signal (ESS)

Emergency Stop Signal alerts the driver behind by blinking the stop lights, whilst sharply and severely braking.

### System operation

The stop light blinks quickly when:

- The vehicle suddenly stops. (The deceleration power exceeds  $7\text{ m/s}^2$ , and the driving speed exceeds  $55\text{ km/h}$  ( $34\text{ mph}$ .)
- ABS is activated.

### System off

After the blinking of the stop lights, the hazard warning flasher automatically turns ON when:

- Driving speed is under  $40\text{ km/h}$  ( $25\text{ mph}$ ) and the sudden braking situation is over.
- ABS is deactivated.

The hazard warning flasher turns OFF when:

- The vehicle drives at a low speed for a certain period of time.
- The driver can manually turn OFF the hazard warning flasher by pressing the button.

### CAUTION

Emergency Stop Signal does not activate, when the hazard warning flashers are already on.

---

## Good braking practices

### WARNING

Whenever leaving the vehicle or parking, always come to a complete stop and continue to depress the brake pedal. Shift the gear to the P (Park) position, then apply the EPB, and place the ignition switch or Engine Start/Stop button on the OFF position.

Vehicles parked with the EPB not applied or not fully engaged may roll inadvertently and may cause injury to the driver and others. ALWAYS apply the parking brake before exiting the vehicle.

---

Wet brakes can be dangerous! The brakes may get wet if the vehicle is driven through standing water or if it is washed. Your vehicle will not stop as quickly if the brakes are wet. Wet brakes may cause the vehicle to pull to one side.

To dry the brakes, apply the brakes slightly until the braking action returns to normal. If the braking action does not return to normal, stop as soon as it is safe to do so. We recommend that your vehicle be inspected by a HYUNDAI authorised repairer.

DO NOT drive with your foot resting on the brake pedal. Even light, but constant pedal pressure can result in the brakes overheating, brake wear, and possibly even brake failure.

If a tyre goes flat whilst you are driving, apply the brakes gently and keep the vehicle pointed straight ahead whilst you slow down. When you are moving slowly enough for it to be safe to do so, pull off the road and stop in a safe location.

Keep your foot firmly on the brake pedal when the vehicle is stopped to prevent the vehicle from rolling forward.

## Idle Stop and Go (ISG)

 if equipped

Idle Stop and Go helps reduce fuel consumption by automatically shutting down the engine, when the vehicle is at a standstill (i.e. red stop light, stop sign, and traffic jam). ISG system is always active, when the engine is running.

### *i* Information

When the engine is automatically started by the ISG system, warning lights (e.g. ABS, ESC, ESC OFF, MDPS, and parking brake warning light) may illuminate for a few seconds if the battery voltage is low and does not indicate a malfunction with the ISG system.

## ISG System Operation

### *Prerequisite for activation*

- The driver's seatbelt is fastened.
- The driver's door and bonnet are closed.
- The brake vacuum pressure is adequate.
- The battery sensor is activated and the battery is sufficiently charged.
- Outside temperature is not too low or too high.
- The vehicle is driven over a constant speed and stops.
- The climate control system satisfies the conditions.
- The vehicle is sufficiently warmed up.
- ISG related parts are working properly.
- The incline is gradual.
- The steering wheel is turned less than 180 degrees before the vehicle stops.

### *i* Information

If the Auto Stop (A) indicator is white on the instrument cluster, the ISG system does not meet the prerequisites above and is not active. If the Auto Stop (A) indicator is yellow, we recommend that your vehicle be inspected by a HYUNDAI authorised dealer.

### *Auto stop*

When ISG is on, the engine stops automatically when both of the following occur:

1. Vehicle speed decreases to 0 km/h (0 mph) (full stop condition).
2. Brake pedal is depressed and gear is in D (Drive) or N (Neutral).

The Auto Stop (A) indicator illuminates in green on the instrument cluster, when the engine stops.

### *i* Information

Idle stop cannot occur again until the vehicle speed goes above 5 km/h (3 mph) and then comes to a full stop again.

In Auto Stop mode, if the bonnet is opened, ISG system is deactivated.

When the system is deactivated, the ISG OFF button indicator illuminates and the message, "**Auto stop is Off. Shift to P or N to start engine manually**" appears on the cluster display with a warning sound.

If this occurs, depress the brake pedal and restart the engine manually.

### Auto start

When ISG stops the engine automatically, the engine restarts if:

- The brake pedal is released.
- You take your foot off the brake pedal and then depress the accelerator pedal when Auto Hold is activated.
- You shift the gear from N (Neutral) or D (Drive) to R (Reverse) or P (Park) whilst depressing the brake pedal.
- You shift the gear from N (Neutral) to D (Drive) whilst depressing the brake pedal.

The Auto Stop (A) indicator goes to white on the instrument cluster, when the engine is restarted.

### Warning messages

**Auto stop is Off. Shift to P or N to start engine manually**



When the system is deactivated, the ISG off button indicator illuminates and a message appears on the cluster display with a warning sound if:

- The bonnet is opened.
- ISG system is not working normally.

If this occurs, depress the brake pedal and restart the engine manually. For your safety, restart the vehicle in the P (Park) position.

### Release brake pedal for Auto Start

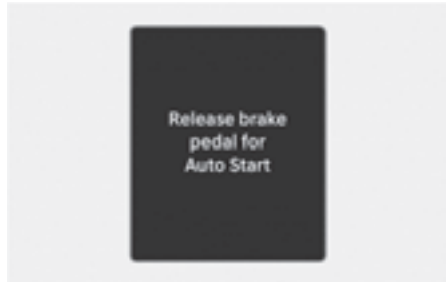

When the gear is shifted from N (Neutral) to R (Reverse), D (Drive), or Manual shift mode without the brake pedal depressed, a message appears on the cluster display. To activate auto start, depress the brake pedal.

### AUTO STOP elapsed time reset

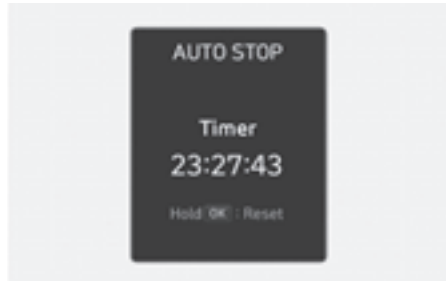

You can view the AUTO STOP elapsed time in the utility view. To view the elapsed time for **AUTO STOP** since the last reset, select **Settings > Cluster > AUTO STOP elapsed time** in the infotainment system.

The AUTO STOP elapsed time reset depends on which utility view mode is linked.

- When Drive information is selected, the AUTO STOP elapsed time resets whenever Drive information is reset.
- When Since refuelling is selected, the AUTO STOP elapsed time resets whenever Since refuelling is reset.
- When Accumulated info is selected, the AUTO STOP elapsed time resets whenever Accumulated info is reset.
- When link is not selected, the AUTO STOP elapsed time is not linked with other information. Press and hold the **OK** button on the steering wheel to reset the elapsed time.

For more information, refer to the “4-29” section in chapter 4.

## ISG System off



Press the ISG OFF button to turn off the ISG system. The ISG OFF button indicator illuminates. To use the system, press the ISG OFF button again.

### NOTICE

It is recommend to Switch Off the Idle Stop and Go function when driving in flooded areas, this will avoid electrical equipment damage due to water entry.

## Conditions that restart the engine

The engine is automatically restarted if:

- The brake vacuum pressure is low.
- The engine has stopped for about 5 minutes.
- The air conditioning is ON with the fan speed set to a certain high level.
- The front defroster is ON.
- The battery is weak.
- The cooling and heating performance of the climate control system is unsatisfactory.
- The vehicle is shifted to P (Park) or R (Reverse) when Auto Hold is activated.
- The door is opened or the seatbelt is unfastened when Auto Hold is activated.
- The EPB switch is pressed when Auto Hold is activated.

The Auto Stop (Ⓐ) indicator blinks in green for 5 seconds on the instrument cluster when the engine is restarted.

### ⚠ WARNING

When the engine is in Idle Stop mode, the engine may restart without the driver taking any action. Before leaving the vehicle or working in the engine compartment, turn off the engine by moving the Engine Start/Stop button to the OFF position, shifting to P (Park), applying the parking brake, and taking the key with you when you leave the vehicle.

## ISG Malfunction

ISG system may not operate if:

- The Auto Stop (A) indicator illuminates in yellow on the instrument cluster.
- The ISG OFF button illuminates.

We recommend that your vehicle be inspected by a HYUNDAI authorised dealer.

## Calibrating the Battery Sensor

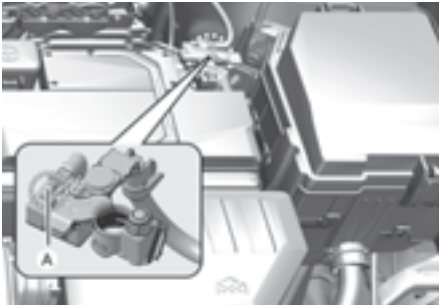

[A] Battery sensor

If the AGM battery is reconnected or replaced, the ISG system does not operate immediately. If you want to use the system, the battery sensor needs to be calibrated following the procedure.

1. Turn off the engine.
2. Disconnect all electronic devices that were additionally installed after the vehicle was delivered, such as navigation, dashcam, etc.
3. After 4 hours with the engine off, turn the engine on and off 3 to 4 times.

## *i* Information

The ISG system may not operate in the following situations.

- There is a malfunction with the ISG system.
- The battery is weak.
- The brake vacuum pressure is low.

If this occurs, we recommend that your vehicle be inspected by a HYUNDAI authorised dealer.

## NOTICE

- Use only a genuine HYUNDAI AGM battery for replacement. If not, the ISG system may not operate properly.
- Do not recharge the AGM battery with a general battery charger. It may damage or explode the AGM battery.
- Do not remove the battery cap. The battery electrolyte, which is harmful to the human body may leak out.



## Drive mode integrated control system

 if equipped

### Selecting drive mode

The drive mode can be selected according to the driver's preference or road condition.

### Changing drive mode



The mode changes, as the following, whenever the DRIVE/TRACTION knob is turned to the right or left, DRIVE/TRACTION button is pressed, or the Drive mode switch is pushed up or down.

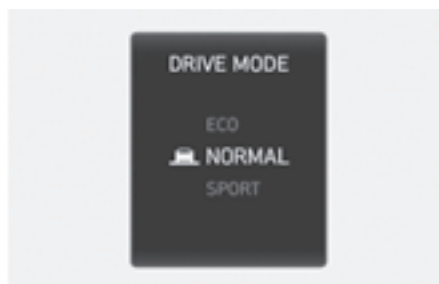

- ECO ↔ NORMAL ↔ SPORT

The mode changes whenever the DRIVE MODE selection button is pressed.

### **ECO, NORMAL, SPORT mode features**

#### ECO mode

ECO mode helps improve fuel efficiency for eco-friendly driving.

Fuel efficiency varies according to the driver's driving habit and road condition.

- When ECO mode is selected, the ECO indicator illuminates on the instrument cluster.
- When ECO mode is activated:
  - The acceleration response may be slightly reduced if the accelerator pedal is depressed moderately.
  - The air conditioner performance may be limited.
  - The shift pattern of the transmission may change.
  - Engine noise may be louder at some transmission shifts as downshift requires pressing down more on the accelerator pedal.

The above situations are normal conditions when ECO mode is activated to help improve fuel efficiency.

### **NORMAL mode**

NORMAL mode provides smooth driving and comfortable riding.

NORMAL mode is selected, it does not appear on the instrument cluster.

### **SPORT mode**

SPORT mode provides sporty but firm riding.

In SPORT mode, the fuel efficiency may decrease.

- When the SPORT mode is selected, the SPORT indicator illuminates on the instrument cluster.
- The drive mode resets to NORMAL mode when the engine is restarted.
- When the SPORT mode is activated:
  - The engine RPM tends to remain raised over a certain time even after releasing the accelerator pedal.
  - Upshifts are delayed when accelerating.

## Selecting traction control mode



Traction control helps achieve optimal driving performance by controlling engine and braking according to the road conditions.

Press the DRIVE/TRACTION button to change from drive mode to traction control mode.

### ***Changing traction control mode***

The mode changes, as the following, whenever the DRIVE/TRACTION knob is turned to the right or left.

Traction control (SNOW, MUD, SAND) mode offers special traction tuning for snow, mud, and sand optimizing available traction in adverse conditions. Traction control mode adjusts the left and right wheel slip control, engine torque, and shift patterns according to available terrain levels.

Selected mode		Description
SNOW		<ul style="list-style-type: none"> <li>• Use this mode when driving on slippery roads.</li> <li>• The engine's driving power is properly distributed to the wheels, to help start the vehicle stably on slippery roads or keep tyres from slipping.</li> </ul>
MUD		<ul style="list-style-type: none"> <li>• Use this mode when driving on muddy, unpaved or uneven roads.</li> <li>• The engine's driving power is properly distributed to the wheels, to secure sufficient driving force that helps start the vehicle.</li> </ul>
SAND		<ul style="list-style-type: none"> <li>• Use this mode when driving on smooth, dry sand or deep gravel and unpaved roads.</li> <li>• The engine's driving power is properly distributed to the wheels, to help drive safely on smooth, dry sand or deep gravel and unpaved roads.</li> </ul>

When the SNOW, MUD, or SAND mode is selected, the corresponding indicator illuminates on the instrument cluster.

## Special driving conditions

### Hazardous driving conditions

When hazardous driving conditions are encountered such as water, snow, ice, mud, and sand:

- Drive cautiously and allow for longer braking distances.
- Avoid abrupt braking or steering.
- If your vehicle is stuck in snow, mud, or sand, use the second gear. Accelerate slowly to avoid unnecessary wheel spin.
- Put sand, rock salt, tyre chains, or other non-slip materials under the wheels to provide additional traction, if stuck in ice, snow, or mud.

#### WARNING

Downshifting with an dual clutch transmission whilst driving on slippery surfaces may cause a collision. The sudden change in tyre speed may cause the tyres to skid. Be careful when downshifting on slippery surfaces.

---

### Rocking the vehicle

If it is necessary to rock the vehicle to free it from snow, sand, or mud, first turn the steering wheel right and left to clear the area around your front wheels. Then, shift back and forth between 1st and R (Reverse, for manual transmission vehicle) or R (Reverse) and a forward gear (for automatic transmission/intelligent variable transmission/dual clutch transmission vehicle).

Try to avoid spinning the wheels, and do not race the engine.

To prevent transmission wear, wait until the wheels stop spinning before shifting gears. Release the accelerator pedal whilst shifting, and press lightly on the accelerator pedal whilst the transmission is in gear. Slowly spinning the wheels in forward and reverse directions causes a rocking motion that may free the vehicle.

#### WARNING

Always turn off the ESC system before rocking the vehicle. If the vehicle is stuck and excessive wheel spin occurs, the temperature in the tyres may increase very quickly. If the tyres become damaged, a tyre blow out or tyre explosion may occur - you and others may be injured. Do not attempt this procedure if people or objects are near the vehicle.

If you attempt to free the vehicle, the vehicle may overheat quickly, possibly causing an engine compartment fire or other damage. Try to avoid spinning the wheels as much as possible to prevent overheating of the tyres or the engine. DO NOT allow the vehicle to spin the wheels above 56 km/h (35 mph).

If you are still stuck after rocking the vehicle a few times, have the vehicle pulled out by a tow vehicle to avoid engine overheating, possible damage to the transmission, and tyre damage. Refer to the “Towing” section in Chapter 8.

---

### Smooth cornering

Avoid braking or gear changing in corners, especially when roads are wet. Ideally, corners should be taken under gentle acceleration.

## Driving at night

Night driving presents more hazards than driving in the daylight. Here are some important tips to remember:

- Slow down and keep more distance between you and other vehicles, because it may be more difficult to see at night, especially in areas where there are no street lights.
- Adjust your mirrors to reduce the glare from other drivers' headlights.
- Keep your headlights clean and properly aimed. Dirty or improperly aimed headlights can make it much more difficult to see at night.
- Avoid staring directly at the headlights of oncoming vehicles. You may be temporarily blinded, and it takes several seconds for your eyes to readjust to the darkness.

## Driving in the rain

Rain and wet roads can make driving dangerous. When driving in the rain or on slick pavement:

- Slow down and allow extra following distance. A heavy rainfall makes it harder to see and increases the distance needed to stop your vehicle.
- Turn OFF your Cruise Control.
- Replace your windscreen wiper blades when they show signs of streaking or missing areas on the windscreen.
- Make sure your tyres have enough tread. If your tyres do not have enough tread, making a quick stop on wet pavement may cause a skid and possibly lead to a collision. Refer to the "Tyres and wheels" section in Chapter 9.
- Turn on your headlights to make it easier for others to see you. Using your headlights when using your windscreen wipers is required in some jurisdictions.

- Driving too fast through large puddles may affect your brakes. If you must go through puddles, try to drive through them slowly.
- If you believe your brakes are wet, apply them several times whilst the vehicle is moving slowly.

## Hydroplaning

If the road is wet enough and you are driving fast enough, your vehicle may have little or no contact with the road surface and actually ride on the water. The best advice is SLOW DOWN when the road is wet.

The risk of hydroplaning increases as the depth of tyre tread decreases, refer to the "Tyres and wheels" section in chapter 9.

## Driving in flooded areas

Avoid driving through flooded areas unless you are sure the water is not deeper than the bottom of the wheel hub. If you are not sure, turn around and find a different route.

Drive through any water slowly. Allow adequate stopping distance because the brake performance can be reduced.

After driving through water, dry the brakes by gently applying them several times whilst the vehicle is moving slowly.

## Highway driving

### **Tyres**

Adjust the tyre inflation, as specified.

Under-inflation may overheat or damage the tyres.

Do not install worn-out or damaged tyres, which may reduce traction or fail.

### **i Information**

Never over-inflate your tyres above the maximum inflation pressure, as specified on your tyres.

---

### **Fuel, engine coolant and engine oil**

Driving at higher speeds on the highway consumes more fuel and is less efficient than driving at a slower, more moderate speed. Maintain a moderate speed to conserve fuel when driving on the highway.

Check both the engine coolant level and the engine oil before driving.

### **Drive belt**

A loose or damaged drive belt may overheat the engine.

### **Reducing the risk of rollover**

Your multi-purpose passenger vehicle is defined as a Sports Utility Vehicle (SUV). Some SUVs have higher ground clearance and a narrower track to make them capable of performing in a wide variety of off-road applications. The specific design characteristics can give them a higher centre of gravity than ordinary passenger vehicles making them more likely to roll over if you make abrupt turns. SUVs have a significantly higher rollover rate than other types of vehicles. Always make sure you and your passengers wear your seat belts properly and securely. In a rollover crash, an unbelted person is significantly

more likely to be seriously injured or killed than a person wearing a seat belt.

There are steps that a driver can make to reduce the risk of a rollover. If at all possible, avoid sharp turns or abrupt manoeuvres, do not load your vehicle with heavy cargo on the roof, and never modify your vehicle in any way.

### **⚠ WARNING**

Some Sports Utility Vehicles (SUVs) can have a significantly higher rollover rate than other types of vehicles. To prevent rollovers or loss of control:

- Take corners at slower speeds than you would with a passenger vehicle.
  - Avoid sharp turns and abrupt manoeuvres.
  - Do not modify your vehicle in any way that you would raise the centre of gravity.
  - Keep tyres properly inflated.
  - Do not carry heavy cargo on the roof.
- 

### **⚠ WARNING**

Fasten your seat belt properly. In a rollover crash, an unbelted person is significantly more likely to be seriously injured or killed than a person wearing a seat belt.

---

## Winter driving

### Snow or icy conditions

You need to keep sufficient distance between your vehicle and the vehicle in front of you.

Apply the brakes gently. Speeding, rapid acceleration, sudden brake applications, and sharp turns are very hazardous practices. When decelerating, use engine braking to the fullest extent. Sudden brake applications on snowy or icy roads may cause the vehicle to skid.

To drive your vehicle in deep snow, it may be necessary to use snow tyres or to install tyre chains on your tyres.

Always carry emergency equipment. You may want to carry tyre chains, tow straps or chains, a flashlight, emergency flares, sand, a shovel, jumper cables, a window scraper, gloves, ground cloth, coveralls, a blanket, etc.

### Snow tyres

#### WARNING

Snow tyres should be equivalent in size and type to the vehicle's standard tyres. Otherwise, the safety and handling of your vehicle may be adversely affected.

Use snow tyres when the road temperature is below 7 °C (45 °F). If you mount snow tyres on your vehicle, be sure to use the same inflation pressure as the original tyres. Mount snow tyres on all four wheels to balance your vehicle's handling in all weather conditions.

The traction provided by snow tyres on dry roads may not be as high as your vehicle's original equipment tyres. Check with the tyre dealer for maximum speed recommendations.

### Tyre chains



Since the sidewalls of radial tyres are thinner than other types of tyres, they may be damaged by mounting some types of tyre chains on them. Therefore, the use of snow tyres is recommended instead of tyre chains. If tyre chains must be used, use genuine HYUNDAI Parts and install the tyre chains after reviewing the instructions provided with the tyre chains. Damage to your vehicle caused by improper tyre chain use is not covered by your vehicle manufacturer's warranty.

#### WARNING

The use of tyre chains may adversely affect vehicle handling:

- Drive less than 30 km/h (20 mph) or the chain manufacturer's recommended speed limit, whichever is lower.
- Drive carefully and avoid bumps, holes, sharp turns, and other road hazards, which may cause the vehicle to bounce.
- Avoid sharp turns or locked wheel braking.
- Install tyre chains only in pairs and on the front tyres. Installing tyre chains on the tyres provides a greater driving force, but does not prevent side skids.

### **i** Information

Do not install studded tyres without first checking local and municipal regulations for possible restrictions against their use.

#### **Chain Installation**

When installing tyre chains, follow the manufacturer's instructions and mount them as tightly possible. Drive slowly (less than 30 km/h (20 mph) or the chain manufacturer's recommended speed limit) with chains installed. If you hear the chains contacting the body or chassis, stop and tighten them. If they still make contact, slow down until the noise stops. Remove the tyre chains as soon as you begin driving on cleared roads.

When mounting snow chains, park the vehicle on level ground away from traffic. Turn on the vehicle's Hazard Warning Flasher and place a triangular emergency warning device behind the vehicle (if available). Always place the vehicle in P (Park), apply the EPB, and turn off the engine before installing snow chains.

#### **NOTICE**

When using tyre chains:

- Wrong size chains or improperly installed chains may damage your vehicle's brake lines, suspension, body, and wheels.
- Use SAE "S" class or wire chains.
- If you hear noise caused by chains contacting the body, retighten the chains to prevent contact with the vehicle body.
- To prevent body damage, retighten the chains after driving 0.5-1.0 km (0.3-0.6 mi.).
- Do not use tyre chains on vehicles equipped with aluminium wheels. If unavoidable, use a wire type chain.

- Use wire chains less than 0.47 inches (12 mm) thick to prevent damage to the chain's connection.

## Winter precautions

### **Use high quality ethylene glycol coolant**

Your vehicle is delivered with high quality ethylene glycol coolant in the cooling system. It is the only type of coolant that should be used because it helps prevent corrosion in the cooling system, lubricates the water pump, and prevents freezing. Be sure to replace or replenish your coolant in accordance with the Maintenance schedule. Before winter, have your coolant tested to make sure that its freezing point is sufficient for the temperatures anticipated during the winter.

### **Check battery and cables**

Winter temperatures may affect the battery performance. Inspect the battery and cables, as specified in the Maintenance schedule. The battery charging level can be checked by a HYUNDAI authorised repairer or in a service station.

### **Change to "winter weight" oil if necessary**

In some regions during winter, it is recommended to use the "winter weight" oil with lower viscosity. In addition, replace the engine oil and filter if it is close to the next maintenance interval. Fresh engine oil ensures optimum engine operation during the winter months. For more information, refer to chapter 2. When you are not sure about a type of winter weight oil, we recommend that you contact a HYUNDAI authorised repairer.



### ***Check spark plugs and ignition system***

Inspect the spark plugs, as specified in the Maintenance schedule. If necessary, replace them. Also check all ignition wirings and components for any cracks, wear, and damage.

### ***To prevent locks from freezing***

Spray approved de-icing fluid or glycerin into key holes. When a lock opening is already covered with ice, spray approved de-icing fluid over the ice to remove it. When an internal part of a lock freezes, try to thaw it with a heated key. Carefully use the heated key to avoid an injury.

### ***Use approved window washer antifreeze solution***

Add window washer anti-freeze solution, as specified on the window washer container. Window washer anti-freeze solution is available from a HYUNDAI authorised repairer, and most vehicle accessory outlets.

### ***i Information***

Do not use engine coolant or other types of anti-freeze solution, to prevent any damage to the vehicle paint.

### ***Do not let your parking brake freeze***

Under some conditions, your parking brake may freeze in the engaged position. This is most likely to happen when there is an accumulation of snow or ice around or near the rear brakes or the brakes are wet. When there is the risk that your parking brake may freeze: temporarily apply the parking brake with the gear in P (Park), then block the rear wheels, and then release the parking brake.

### ***Do not let ice and snow accumulate underneath***

Under some conditions, snow and ice may build up under the fenders and interfere with the steering. When driving in such conditions during the severe winter, check underneath the vehicle on a regular basis, to make sure that the front wheels and the steering components are not blocked.

### ***Carry emergency equipment***

In accordance with weather conditions, carry appropriate emergency equipment, whilst driving. Some of the items you may want to carry include tyre chains, tow straps or chains, flashlight, emergency flares, sand, shovel, jumper cables, window scraper, gloves, ground cloth, coveralls, blanket, etc.

### ***Do not place objects or materials in the engine compartment***

Putting objects or materials in the engine compartment may cause an engine failure or a fire, because they may block the engine cooling. Such damage is not covered by the manufacturer's warranty.

### ***Drive your vehicle when water vapour condenses and accumulates inside the exhaust pipes***

When the vehicle is stopped for a long time in winter whilst the engine is running, water vapour may condense and accumulate inside the exhaust pipes. Water in the exhaust pipes may cause noise, etc., but it is drained driving at medium to high speed.

## Vehicle weight

Two labels on your driver's door still show how much weight your vehicle was designed to carry: the Tyre and Loading Information Label and the Certification Label.

Before loading your vehicle, familiarize yourself with the following terms for determining your vehicle's weight ratings, from the vehicle's specifications and the Certification Label:

### Base Kerb Weight

This is the weight of the vehicle including a full tank of fuel and all standard equipment. It does not include passengers, cargo, or optional equipment.

### Vehicle Kerb Weight

This is the weight of your new vehicle when you picked it up from your dealer plus any aftermarket equipment.

### Cargo Weight

This figure includes all weight added to the Base Kerb Weight, including cargo and optional equipment.

### GAW (Gross Axle Weight)

This is the total weight placed on each axle (front and rear) - including vehicle kerb weight and all payload.

### GAWR (Gross Axle Weight Rating)

This is the maximum allowable weight that can be carried by a single axle (front or rear). These numbers are shown on the Certification Label. The total load on each axle must never exceed its GAWR.

### GVW (Gross Vehicle Weight)

This is the Base Kerb Weight plus actual Cargo Weight plus passengers.

### GVWR (Gross Vehicle Weight Rating)

This is the maximum allowable weight of the fully loaded vehicle (including all options, equipment, passengers and cargo). The GVWR is shown on the Certification Label located on the driver's door sill.

## Overloading

### WARNING

The Gross Axle Weight Rating (GAWR) and the Gross Vehicle Weight Rating (GVWR) for your vehicle are on the Certification Label attached to the driver's (or front passenger's) door. Exceeding these ratings can cause an accident or vehicle damage. You can calculate the weight of your load by weighing the items (and people) before putting them in the vehicle. Be careful not to overload your vehicle.

---

# 7. Driver Assistance System

## NOTICE

- **The Driver Assistance System uses camera and radar system to give signals and controls to improve the safety surroundings and comfort of the driver. It should be noted that ADAS only assists the driver and it does not interchange or substitute with the driver.**
- **The ADAS delivers vast benefits to driver, but the driver shall be only accountable for driving the car. Driver must be attentive while driving and should follow the traffic rules and regulations.**

Driver assistance system notice .....	7-3
Forward Collision-Avoidance Assist (FCA) (Sensor fusion) .....	7-3
Forward Collision-Avoidance assist settings .....	7-5
Forward Collision-Avoidance assist operation .....	7-7
Forward Collision-Avoidance assist malfunction and limitations .....	7-12
Lane Keeping Assist (LKA) .....	7-20
Lane Keeping Assist settings .....	7-20
Lane Keeping Assist operation .....	7-21
Lane Keeping Assist malfunction and limitations .....	7-23
Blind-Spot Collision-Avoidance Assist (BCA) .....	7-26
Blind-Spot Collision-Avoidance Assist settings .....	7-28
Blind-Spot Collision-Avoidance Assist operation .....	7-29
Blind-Spot Collision-Avoidance Assist malfunction and limitations .....	7-32
Safe Exit Warning (SEW) .....	7-36
Safe Exit Warning settings .....	7-36
Safe Exit Warning operation .....	7-37
Safe Exit Warning malfunction and limitations .....	7-38
Manual Speed Limit Assist (MSLA) .....	7-40
Manual Speed Limit Assist operation .....	7-40
Driver Attention Warning (DAW) .....	7-42
Driver Attention Warning settings .....	7-42
Driver Attention Warning operation .....	7-43
Driver Attention Warning malfunction and limitations .....	7-44
Blind-Spot View Monitor (BVM) .....	7-47
Blind-Spot View Monitor settings .....	7-48
Blind-Spot View Monitor operation .....	7-48
Blind-Spot View Monitor malfunction .....	7-49

Cruise Control (CC) ..... 7-49  
    Cruise Control operation ..... 7-49

Smart Cruise Control (SCC)..... 7-53  
    Smart Cruise Control settings ..... 7-53  
    Smart Cruise Control operation ..... 7-54  
    Smart Cruise Control malfunction and limitations ..... 7-62

Lane Following Assist (LFA)..... 7-67  
    Lane Following Assist settings ..... 7-67  
    Lane Following Assist operation ..... 7-68  
    Lane Following Assist malfunction and limitations ..... 7-70

Rear View Monitor (RVM)..... 7-70  
    Rear View Monitor settings ..... 7-71  
    Rear View Monitor operation ..... 7-72  
    Rear View Monitor malfunction and limitations ..... 7-74

Surround View Monitor (SVM) ..... 7-74  
    Surround View Monitor settings ..... 7-75  
    Surround View Monitor operation..... 7-76  
    Surround View Monitor malfunction and limitations ..... 7-79

Rear Cross-Traffic Collision-Avoidance Assist (RCCA) ..... 7-80  
    Rear Cross-Traffic Collision-Avoidance Assist settings..... 7-81  
    Rear Cross-Traffic Collision-Avoidance Assist operation..... 7-82  
    Rear cross-traffic collision-avoidance assist malfunction and limitations ..... 7-85

Reverse Parking Distance Warning (PDW)..... 7-89  
    Reverse Parking Distance Warning settings ..... 7-89  
    Reverse Parking Distance Warning operation..... 7-90  
    Reverse Parking Distance Warning malfunction and limitations ..... 7-91

Forward/Reverse Parking Distance Warning (PDW) ..... 7-93  
    Forward/Reverse Parking Distance Warning settings..... 7-93  
    Forward/Reverse Parking Distance Warning operation..... 7-94  
    Forward/Reverse Parking Distance Warning malfunction and limitations..... 7-95

## Driver assistance system notice

Due to the infotainment software version, the description of each function of the driver assistance system may differ from the owner's manual.

## Forward Collision-Avoidance Assist (FCA) (Sensor fusion)

 if equipped

### Basic function

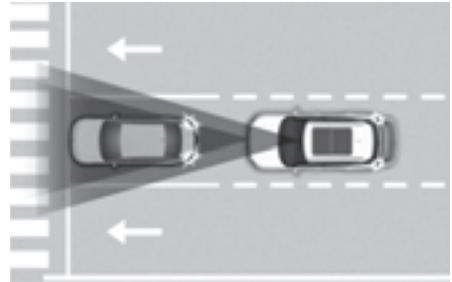

Forward Collision-Avoidance Assist detects a vehicle, a powered two-wheeler, a pedestrian, or a cyclist ahead on the road and may warn you of a possible collision with a warning message on the instrument cluster and a warning sound. Also, Forward Collision-Avoidance Assist may assist with braking your vehicle to help reduce collision speed or avoid a collision.

### Junction Turning function

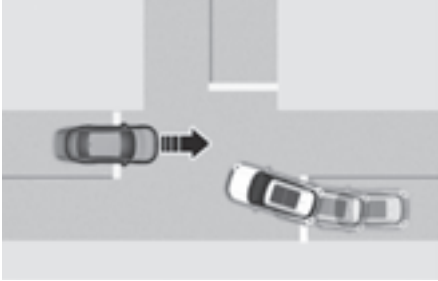

Junction Turning function can help avoid a collision with an oncoming vehicle, powered two-wheeler or cyclist in an adjacent lane when turning right at a crossroad with the turn signal on by applying emergency braking.

### Direct Oncoming function

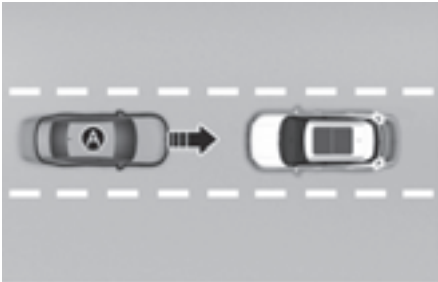

[A] Oncoming vehicle

Direct Oncoming function helps reduce the speed at the collision when a vehicle or powered two-wheeler approaching from the opposite side is detected.

### Detecting sensor



[A] Front view camera  
[B] Front radar

See the illustration above for the detailed location of the detecting sensors.

### CAUTION

Take the following precautions to maintain optimal performance of the detecting sensor:

- Never disassemble the detecting sensor or sensor assembly, or cause any damage to it.
- If the detecting sensors have been replaced or repaired, we recommend that your vehicle be inspected by a HYUNDAI authorised repairer.
- Never install any accessories or stickers on the front windscreen, or tint the front windscreen.
- Exercise extreme caution to keep the front view camera dry.
- Never place any reflective objects (for example, white paper, mirror) over the dashboard.

- Do not place any objects near the front windscreen or install any accessories on the front windscreen. It can affect the performance of the defogging and defrosting function of the climate control system, which may prevent the Driver Assistance systems from operating.
- Do not apply license plate frame or objects, such as a bumper sticker, film or a bumper guard, near the front radar cover.
- Do not change the position of the license plate. The front radar's detection and control performance may be affected.
- Always keep the front radar and cover clean and free of dirt and debris. Use only a soft cloth to wash the vehicle. Do not spray pressurized water directly on the sensor or sensor cover.
- If the radar or around the radar has been damaged or impacted in any way, Forward Collision-Avoidance Assist may not properly operate even though a warning message does not appear on the cluster. We recommend that your vehicle be inspected by a HYUNDAI authorised repairer.
- Use only genuine parts to repair or replace a damaged front radar cover. Do not apply paint to the front radar cover.
- If a trailer or towbar mounted carrier is attached, it may adversely affect the performance of the Forward Collision-Avoidance Assist.

## Forward Collision-Avoidance assist settings

### Forward safety

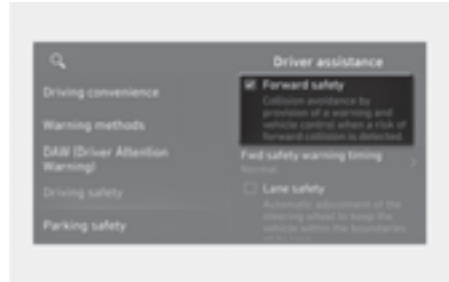

With the vehicle on, select **User settings** > **Driver assistance** > **Driving safety** > **Forward safety** from the settings menu in the instrument cluster or **Settings** > **Vehicle** > **Driver assistance** > **Driving safety** > **Forward safety** from the settings menu in the infotainment system to set whether to use each function.

- If **Forward safety** is selected, Forward Collision-Avoidance Assist will warn the driver with a warning message, an audible warning depending on the collision risk levels. Braking assist will be applied depending on the collision risk levels. If **Forward safety** is deselected, Forward safety will turn off. The warning light (⚠️) will illuminate on the cluster.

### ⚠️ WARNING

If the vehicle is restarted, Forward Safety will maintain the last setting. However, if 'Forward safety' is deselected, the driver should always be aware of the surroundings and drive safely.

### ⚠️ CAUTION

The setting for Forward safety includes 'Basic function', 'Junction Turning', and 'Direct Oncoming'.

### Forward Safety Warning Timing

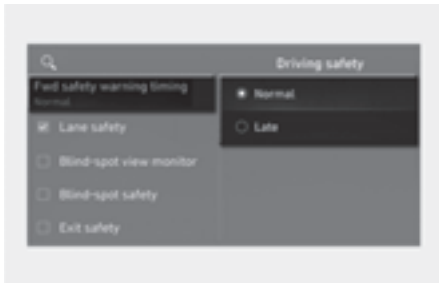

With the vehicle on, select **User settings > Driver assistance > Driving safety > Forward safety warning timing** from the settings menu in the instrument cluster or **Settings > Vehicle > Driver assistance > Driving safety > Forward safety warning timing** settings menu in the infotainment system to change the initial warning activation time for Forward Collision-Avoidance Assist. The warning time can be set to either **Normal** or **Late**

- Use **Normal** in normal driving conditions. If the warning timing seems sensitive, change it to **Late**.
  - If **Late** is selected, Forward Collision-Avoidance Assist, warns the driver more slowly.

#### CAUTION

- Even though **Normal** is selected for **Warning timing**, if the front vehicle suddenly stops, the warning may seem late.
- Select **Late** for **Warning timing** when traffic is light and when driving speed is slow.

### Warning methods

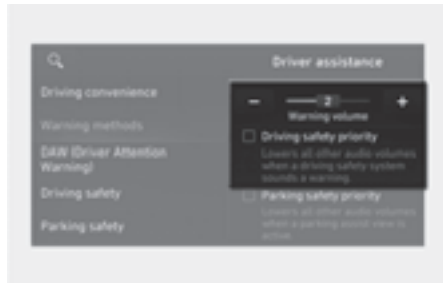

The **Warning methods** can be set with the vehicle on.

- **Warning volume:** Select **User settings > Driver assistance > Warning methods > Warning volume** from the settings menu in the instrument cluster or **Settings > Vehicle > Driver assistance > Warning methods > Warning volume** from the settings menu in the infotainment system to change the warning volume.
- **Driving safety priority:** Select **Settings > Vehicle > Driver assistance > Warning methods > Driving safety priority** from the settings menu in the infotainment system.

If **Driving safety priority** is selected, the vehicle lowers all other audio volumes when the warning sounds for safe driving.

#### Information

- If you change the **Warning methods**, the warning methods of other driver assistance systems may change.
- If the vehicle is restarted, **Warning methods** will maintain the last setting.
- The setting menu may not exist based on vehicle specification.



## Forward Collision-Avoidance assist operation

### Basic function

The basic function for Forward Collision-Avoidance Assist is to warn and help control the vehicle depending on the collision risk level: 'Collision Warning', 'Emergency Braking' and 'Stopping vehicle and ending brake control'.

### Collision Warning



To warn the driver of a collision, the "**Collision warning**" warning message appears and the (⚠️) warning light blinks on the cluster with warning sound.

- If a vehicle or powered two-wheeler is detected in front, the function will operate when your vehicle speed is between about 10-200 km/h (6-124 mph).
- If a pedestrian or cyclist is detected in front, the function will operate when your vehicle speed is between about 10-85 km/h (6-53 mph).

### Emergency Braking



To warn the driver that emergency braking will be assisted, the "**Emergency Braking**" warning message appears and the (⚠️) warning light blinks on the cluster with warning sound.

Emergency braking will operate under the following conditions.

- Vehicle or powered two-wheeler:

	Driving vehicle	Stopped vehicle
Weak braking power	About 10-200 km/h (6-124 mph)	
Strong braking power	About 10-130 km/h (6-80 mph)	About 10-75 km/h (6-47 mph)

- Pedestrian or cyclist:

The function will operate when your vehicle speed is between about 10-65 km/h (6-40 mph).

### Stopping vehicle and ending brake control



When the vehicle is stopped due to emergency braking, the “**Drive carefully**” warning message will appear on the cluster.

For your safety, the driver should depress the brake pedal immediately and check the surroundings.

- Brake control will end after the vehicle is stopped by emergency braking for about 2 seconds.

### **i** Information

Press the hazard warning flasher to turn off the audible warning of the collision warning or emergency braking system.

---

### **Junction Turning function**

Junction Turning function will warn and help control the vehicle depending on the collision risk level: ‘Collision Warning’, ‘Emergency Braking’ and ‘Stopping vehicle and ending brake control’

### Collision Warning



To warn the driver of a collision, the “**Collision warning**” warning message appears and the (⚠️) warning light blinks on the cluster with warning sound.

The function will operate when:

- Your vehicle speed is between about 10-30 km/h (6-19 mph).
- The oncoming vehicle speed is between about 30-70 km/h (19-44 mph).
- The powered two-wheeler or cyclist speed is between about 15-70 km/h (9-44 mph).

## Emergency Braking



To warn the driver that emergency braking will be assisted, the “**Emergency Braking**” warning message appears and the (⚠️) warning light blinks on the cluster with warning sound.

In emergency braking situation, braking is assisted with strong braking power to help prevent collision with the oncoming vehicle, powered two-wheeler or cyclist.

The function will operate when:

- Your vehicle speed is between about 10-30 km/h (6-19 mph).
- The oncoming vehicle speed is between about 30-70 km/h (19-44 mph).
- The powered two-wheeler or cyclist speed is between about 15-70 km/h (9-44 mph).

### *i* Information

If the driver’s seat is on the left side, Junction Turning function will operate only when you turn left. If the driver’s seat position is on the right side, the function will operate only when you turn right.

## Stopping vehicle and ending brake control



- When the vehicle is stopped due to emergency braking, the “**Drive carefully**” warning message will appear on the cluster.

For your safety, the driver should depress the brake pedal immediately and check the surroundings.

- Brake control will end after the vehicle is stopped by emergency braking for about 2 seconds.

### Direct Oncoming function

Direct Oncoming function will warn and control the vehicle depending on the collision risk level: 'Collision Warning', 'Emergency Braking', and 'Stopping vehicle and ending brake control'.

#### Collision Warning



To warn the driver of a collision, the “**Collision warning**” warning message appears and the (⚠️) warning light blinks on the cluster with warning sound.

The function will operate when:

- Your vehicle speed is between about 30-130 km/h (6-80 mph).
- The oncoming vehicle or powered two-wheeler speed is 10 km/h (6 mph) and over.

#### Emergency Braking

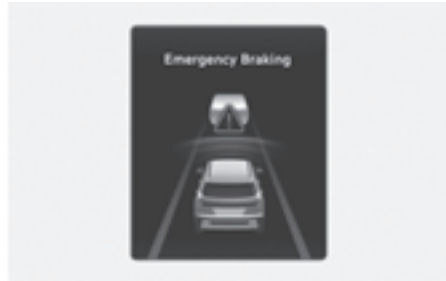

To warn the driver that emergency braking will be assisted, the “**Emergency Braking**” warning message appears and the (⚠️) warning light blinks on the cluster with warning sound.

In emergency braking situation, braking is assisted with strong braking power to help prevent collision with the oncoming vehicle or powered two-wheeler.

The function will operate when:

- Your vehicle speed is between about 30-130 km/h (6-80 mph).
- The oncoming vehicle or powered two-wheeler speed is 10 km/h (6 mph) and over.

## Stopping vehicle and ending brake control



- When the vehicle is stopped due to emergency braking, the **“Drive carefully”** warning message will appear on the cluster.

For your safety, the driver should depress the brake pedal immediately and check the surroundings.

- Brake control will end after the vehicle is stopped by emergency braking for about 2 seconds.

### CAUTION

- If your vehicle, the oncoming vehicle or powered two-wheeler is not driving straight, Direct Oncoming function warning and control may be late or may not operate.
- When driving at night, the detecting performance of powered two-wheeler may decrease and temporarily limit or disable Front Collision-Avoidance Assist.

### WARNING

- For your safety, only change the Settings after parking the vehicle at a safe location.
- Forward Collision-Avoidance Assist does not operate in all situations and cannot avoid all collisions.
- The driver has the responsibility to control the vehicle. Do not solely depend on Forward Collision-Avoidance Assist. Rather, maintain a safe braking distance, and if necessary, depress the brake pedal to reduce driving speed or to stop the vehicle.
- Never deliberately operate Forward Collision-Avoidance Assist on people, objects, etc. It may cause serious injury or death.
- Forward Collision-Avoidance Assist may not operate if the driver depresses the brake pedal to avoid collision.
- During Forward Collision-Avoidance Assist operation, the vehicle may stop suddenly injuring passengers and shifting loose objects. Always have the seat belt on and keep loose objects secured.
- If any other system’s warning message appears or audible warning is generated, Forward Collision-Avoidance Assist warning message may not be displayed and audible warning may not be generated.

- You may not hear the warning sound of Forward Collision-Avoidance Assist if the surrounding is noisy.
- Forward Collision-Avoidance Assist may turn off or may not operate properly or may operate unnecessarily depending on the road conditions and the surroundings.
- Even if there is a problem with Forward Collision-Avoidance Assist, the vehicle's basic braking performance will operate properly.
- During emergency braking, braking control by Forward Collision-Avoidance Assist will automatically cancel when the driver excessively depresses the accelerator pedal or sharply steers the vehicle.

### CAUTION

- Depending on the condition of the vehicle, powered two-wheeler, and pedestrian and cyclist in front and the surroundings, the speed range to operate Forward Collision-Avoidance Assist may reduce. Forward Collision-Avoidance Assist may only warn the driver, or it may not operate.
- Forward Collision-Avoidance Assist will operate under certain conditions by judging the risk level based on the condition of the vehicle, powered two-wheeler, cyclist, driving direction, speed and surroundings.
- Forward Collision-Avoidance Assist may be limited or disabled if your vehicle speed is too high or the speed difference between your vehicle and powered two-wheeler or cyclist is large.



### Information

- In a situation where collision is imminent, braking may be assisted by Forward Collision-Avoidance Assist when braking is insufficient by the driver.
- The images and colours in the instrument cluster may differ depending on the cluster type or theme selected from the settings menu.

## Forward Collision-Avoidance assist malfunction and limitations

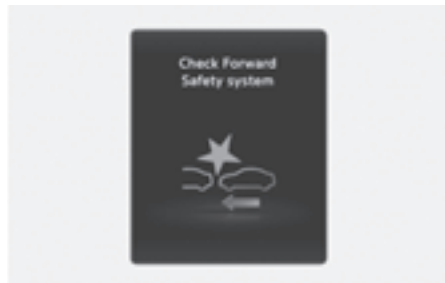
### *Forward Collision-Avoidance Assist malfunction*



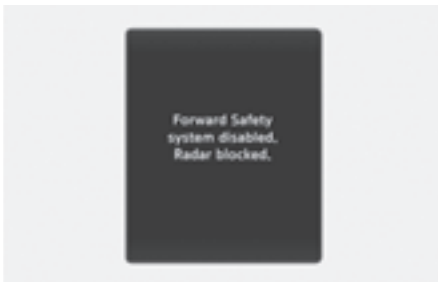

When Forward Collision-Avoidance Assist is not working properly, the **“Check Forward Safety system.”** warning message will appear, and the ,  warning light will illuminate on the instrument cluster. We recommend that your vehicle be inspected by a HYUNDAI authorised repairer.

### **Forward Collision-Avoidance Assist disabled**



When the front windscreen where the front view camera is located, front radar cover, or sensor is covered with foreign material or by inclement weather, such as heavy rain, fog or snow, it can reduce the detecting performance and temporarily limit or disable Forward Collision-Avoidance Assist.

If this occurs the **“Forward Safety system disabled. Camera obscured.”** or the **“Forward Safety system disabled. Radar blocked.”** warning message, and the  and  warning lights will illuminate on the instrument cluster.

Forward Collision-Avoidance Assist will operate properly when snow, rain or foreign material is removed.

If Forward Collision-Avoidance Assist does not operate properly after obstruction (snow, rain, or foreign material) is removed (including trailer, carrier, etc., from the rear bumper), we recommend that your vehicle be inspected by a HYUNDAI authorised repairer.

#### **WARNING**

- Even though the warning message or warning light does not appear on the cluster, Forward Collision-Avoidance Assist may not properly operate.
- Forward Collision-Avoidance Assist may not properly operate in an area (for example, open terrain), where any objects are not detected after turning ON the engine.
- If the vehicle is restarted when the sensors are disabled or malfunctioned, Forward Collision-Avoidance Assist may not operate properly.

### **Limitations of Forward Collision-Avoidance Assist**

Forward Collision-Avoidance Assist may not operate properly, or it may operate unexpectedly under the following circumstances:

- The detecting sensor or the surroundings are contaminated or damaged
- The temperature around the front view camera is high or low due to surrounding environment
- The camera lens is contaminated due to tinted, filmed or coated windscreen, damaged glass, or sticky foreign material (sticker, bug, etc.) on the glass
- Moisture is not removed or frozen on the windscreen
- Washer fluid is continuously sprayed, or the wiper is on
- Driving in heavy rain or snow, or thick fog
- The field of view of the front view camera is obstructed by sun glare
- Street light or light from an oncoming traffic is reflected on the wet road surface, such as a puddle on the road
- An object is placed on the dashboard
- Your vehicle is being towed
- The surrounding is very bright
- The surrounding is very dark, such as in a tunnel, etc.
- The brightness changes suddenly, for example when entering or exiting a tunnel
- The brightness outside is low, and the headlights are not on or are not bright
- Driving through steam, smoke or shadow
- Only part of the vehicle, powered two-wheeler, and pedestrian or cyclist is detected
- The vehicle / object in front is a bus, heavy truck, truck with an unusually shaped cargo, trailer, animal, etc.
- The vehicle and powered two-wheeler in front has no tail lights, tail lights are located unusually, etc.
- The brightness outside is low, and the tail lights are not on or are not bright
- The rear of the front vehicle and powered two-wheeler is small or the vehicle and powered two-wheeler does not look normal, such as when the vehicle is tilted, overturned, or the side of the vehicle is visible, etc.
- The front vehicle's ground clearance is low or high
- A vehicle and powered two-wheeler, and pedestrian or cyclist suddenly cuts in front
- The bumper around the front radar is impacted, damaged or the front radar is out of position
- The temperature around the front radar is high or low
- Driving through a tunnel or iron bridge
- Driving in vast areas where there are few vehicles or structures (for example, desert, meadow, suburb, etc.)
- Driving near areas containing metal substances, such as a construction zone, railroad, etc.
- A material is near that reflects very well on the front radar, such as a guardrail, nearby vehicle, etc.
- The cyclist in front is on a bicycle made of material that does not reflect on the front radar
- The vehicle and powered two-wheeler in front is detected late
- The vehicle and powered two-wheeler in front is suddenly blocked by an obstacle / barricade
- The vehicle and powered two-wheeler in front suddenly changes lane or suddenly reduces speed
- The vehicle and powered two-wheeler in front is bent out of shape



- The front vehicle and powered two-wheeler speed is fast or slow
- The vehicle and powered two-wheeler in front is covered with snow
- You are departing or returning to the lane
- Unstable driving
- You are on a roundabout and the vehicle or powered two-wheeler in front is not detected
- You are continuously driving in a circle
- The vehicle and powered two-wheeler in front has an unusual shape
- The vehicle and powered two-wheeler in front is driving uphill or downhill
- The pedestrian or cyclist is not fully detected, for example, if the pedestrian is leaning over or is not fully walking upright
- The pedestrian or cyclist is wearing clothing or equipment that makes it difficult to detect



The illustration above shows the image the front view camera and front radar are capable of detecting as a vehicle, powered two-wheeler, and pedestrian and cyclist.

- The pedestrian or cyclist in front is moving intersected with the driving direction
  - There is a group of pedestrians, cyclists or a large crowd in front
  - The pedestrian or cyclist is wearing clothing that easily blends into the background, making it difficult to detect
  - The pedestrian or cyclist is difficult to distinguish from the similarly shaped structure in the surroundings
  - You are driving by a pedestrian, cyclist, traffic signs, structures, etc., near the intersection
  - Driving in a parking lot
  - Driving through a tollgate, construction area, unpaved road, partial paved road, uneven road, speed bumps, etc.
  - Driving on an incline road, curved road, etc.
  - Driving through a roadside with trees or streetlights
  - The adverse road conditions cause excessive vehicle vibrations whilst driving
  - Your vehicle height is low or high due to heavy loads, abnormal tyre pressure, etc.
  - Driving through a narrow road where trees or grass are overgrown
  - There is interference by electromagnetic waves, such as driving in an area with strong radio waves or electrical noise
- The pedestrian or cyclist in front is moving very quickly
  - The pedestrian or cyclist in front is short or is posing a low posture
  - The pedestrian or cyclist in front has impaired mobility

**⚠ WARNING**

• **Driving on a curved road**

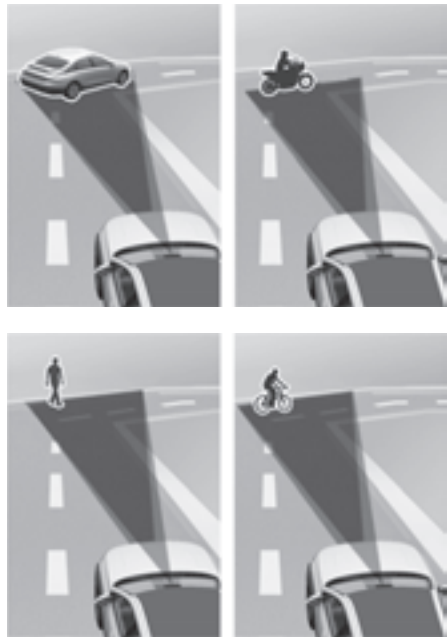
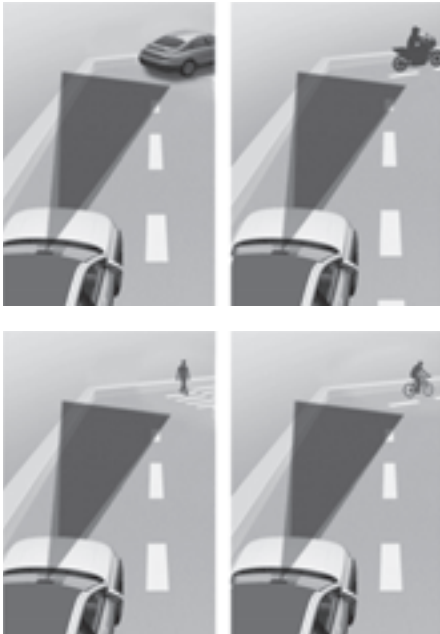

Forward Collision-Avoidance Assist may not detect a vehicle, a powered two-wheeler, and a pedestrian or a cyclist in front of you when driving on curved roads adversely affecting the performance of the sensors. This may result in no warning, braking assist when necessary.

When driving on a curve, you must maintain a safe braking distance, and if necessary, depress the brake pedal to reduce your driving speed in order to maintain a safe distance.

Forward Collision-Avoidance Assist may detect a vehicle, powered two-wheeler, and pedestrian or cyclist in the next lane or outside the lane when driving on a curved road.

If this occurs, Forward Collision-Avoidance Assist may unnecessarily warn the driver and control the brake. Always check the traffic conditions around the vehicle.

- Driving on an inclined road



Forward Collision-Avoidance Assist may not detect a vehicle, a powered two-wheeler, and a pedestrian or a cyclist in front of you whilst driving uphill or downhill, adversely affecting the performance of the sensors.

This may result in unnecessary warning, braking assist or no warning, braking assist when necessary.

Also, vehicle speed may rapidly decrease when vehicle, powered two-wheeler, and pedestrian or cyclist ahead is suddenly detected.

Always have your eyes on the road whilst driving uphill or downhill and if necessary, steer your vehicle and depress the brake pedal to reduce your driving speed in order to maintain a safe distance.

• Changing lanes



[A] Your vehicle  
[B] Lane changing vehicle or powered two-wheeler

- When a vehicle or powered two-wheeler moves into your lane from an adjacent lane, it cannot be detected by the sensor until it is in the sensor's detection range. Forward Collision-Avoidance Assist may not immediately detect the vehicle or powered two-wheeler when the vehicle or powered two-wheeler changes lanes abruptly. In this case, you must maintain a safe braking distance, and if necessary, steer your vehicle and depress the brake pedal to reduce your driving speed in order to maintain a safe distance.



[A] Your vehicle  
[B] Lane changing vehicle  
[C] Same lane vehicle or powered two-wheeler

When a vehicle in front of you merges out of the lane, Forward Collision-Avoidance Assist may not immediately detect the vehicle or powered two-wheeler that is now in front of you. In this case, you must maintain a safe braking distance, and if necessary, steer your vehicle and depress the brake pedal to reduce your driving speed in order to maintain a safe distance.

- If the vehicle in front of you has cargo that extends rearward from the cab, or when the vehicle in front of you has higher ground clearance, additional special attention is required. Forward Collision-Avoidance Assist may not be able to detect the cargo extending from the vehicle. In these instances, you must maintain a safe braking distance from the rearmost object, and if necessary, steer your vehicle and depress the brake pedal to reduce your driving speed in order to maintain distance.



### **WARNING**

- When you are towing a trailer or another vehicle, turn off Forward Collision-Avoidance Assist for safety reasons.
- Forward Collision-Avoidance Assist may operate if objects that are similar in shape or characteristics to vehicles, powered two-wheelers, pedestrians and cyclists are detected.
- Forward Collision-Avoidance Assist does not operate on bicycles, or smaller wheeled objects, such as luggage bags, shopping carts, or strollers.
- Forward Collision-Avoidance Assist may not operate properly if interfered by strong electromagnetic waves.
- Forward Collision-Avoidance Assist may not operate for about 15 seconds after the vehicle is started, or the front view camera is initialized.

## Lane Keeping Assist (LKA)

 If equipped

Whilst driving over a certain speed, Lane Keeping Assist detects lane markings (or road edges) and may warn you if your vehicle leaves the lane without using the turn signal and may assist with steering to prevent your vehicle departing from its travel lane.

### Detecting sensor



[A] Front view camera

The front view camera is used as a detecting sensor to detect lane markings (or road edges).

See the illustration above for the detailed location of the detecting sensor.

### CAUTION

For more information on the precautions of the front view camera, refer to the “Forward Collision-Avoidance Assist (FCA) (Sensor fusion)” section in this chapter.

## Lane Keeping Assist settings

### Lane Safety

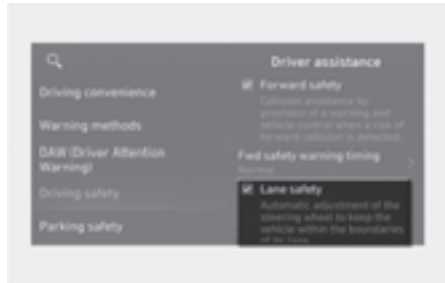

With the vehicle on, select **User settings** > **Driver assistance** > **Driving safety** > **Lane safety** from the settings menu in the instrument cluster or **Settings** > **Vehicle** > **Driver assistance** > **Driving safety** > **Lane safety** from the settings menu in the infotainment system to set whether to use each function.

If **Lane safety** is selected, Lane Keeping Assist automatically assists the driver's steering when lane departure is detected to help prevent the vehicle from moving out of its lane. If **Lane Safety** is deselected, Lane Keeping Assist turns off and the yellow  indicator light appears on the cluster.

### WARNING

- Lane Keeping Assist does not control the steering wheel when the vehicle is driven in the middle of the lane.
- The driver should always be aware of the surroundings. If **Lane safety** is deselected, Lane Keeping Assist cannot assist you.

## Warning Methods

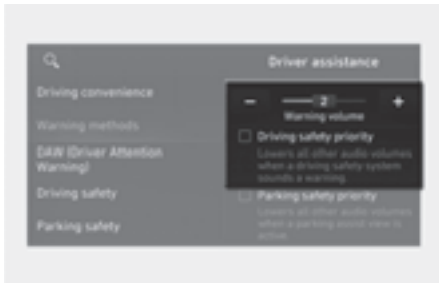

The **Warning methods** can be set with the vehicle on.

- **Warning volume:** Select **User settings > Driver assistance > Warning methods > Warning volume** from the settings menu in the instrument cluster or **Settings > Vehicle > Driver assistance > Warning methods > Warning volume** from the settings menu in the infotainment system to change the warning volume.
- **Driving safety priority:** Select **Settings > Vehicle > Driver assistance > Warning methods > Driving safety priority** from the settings menu in the infotainment system.

If **Driving safety priority** is selected, the vehicle lowers all other audio volumes when the warning sounds for safe driving.

### *i* Information

- If you change the **Warning methods**, the warning methods of other driver assistance systems may change.
- If the vehicle is restarted, **Warning methods** will maintain the last setting.
- The setting menu may not exist based on vehicle specification.

## Lane Keeping Assist operation

### Turning Lane Keeping Assist On/Off



- With the vehicle on, press and hold the Lane Driving Assist button located on the steering wheel to turn on Lane Keeping Assist. The grey or green indicator light illuminates on the cluster.
- When Lane Keeping Assist turns off, the indicator turns yellow.

### *i* Information

- When Lane Driving Assist is ready to operate, the indicator turns gray on the cluster.
- When Lane Driving Assist is operating, the indicator turns green on the cluster.

### Warning and control

Lane Keeping Assist will warn and control the vehicle with Lane Departure Warning and Lane Keeping Assist.

Left



Right



### Lane Departure Warning

- To warn the driver that the vehicle is departing from the projected lane in front, the green indicator light blinks on the cluster, the lane line blinks on the cluster depending on which direction the vehicle is veering, and an audible warning sounds.
- Lane Keeping Assist operates when your vehicle speed is between about 45-200 km/h (28-120 mph).

### Lane Keeping Assist

- To warn the driver that the vehicle is departing from the projected lane in front, the green indicator light blinks on the cluster, and the steering wheel makes adjustments to keep vehicle inside the lane.
- Lane Keeping Assist operates when your vehicle speed is between about 45-200 km/h (28-120 mph).

### Hands-off warning

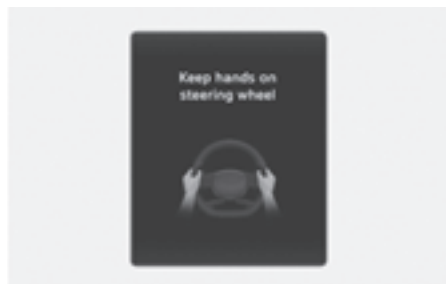

If the driver takes their hands off the steering wheel for several seconds, the **“Keep hands on steering wheel”** warning message appears on the cluster, and an audible warning sounds in stages.

### WARNING

- The steering wheel may not be assisted if the steering wheel is held very tight or the steering wheel is steered over a certain degree.
- Lane Keeping Assist does not operate at all times. It is the responsibility of the driver to safely steer the vehicle and to maintain the vehicle in its lane.
- The hands-off warning message may appear late depending on road conditions. Always have your hands on the steering wheel whilst driving.
- If the steering wheel is held very lightly, the hands-off warning message may appear because Lane Keeping Assist may not recognise that the driver has their hands on the steering wheel.



- If you attach objects to the steering wheel, the hands-off warning may not work properly.

## *i* Information

- Even though the steering is assisted by Lane Keeping Assist, the driver may control the steering wheel.
- The steering wheel may feel heavier or lighter when the steering wheel is assisted by Lane Keeping Assist than when it is not.

Lane undetected



Lane detected



- When lane markings (or road edges) are detected, the lane lines on the cluster changes from grey to white.
- The images and colours in the cluster may differ depending on the cluster type or theme selected from the cluster.
- For more information on instrument cluster settings, refer to the Cluster display modes section in chapter 4.

## Lane Keeping Assist malfunction and limitations

### Lane Keeping Assist malfunction



When Lane Keeping Assist is not working properly, the “**Check Lane Safety system.**” warning message and yellow Lane Keeping Assist (LKA) warning light appears on the cluster. If this occurs, we recommend that your vehicle be inspected by a HYUNDAI authorised repairer.

### Lane Keeping Assist disabled

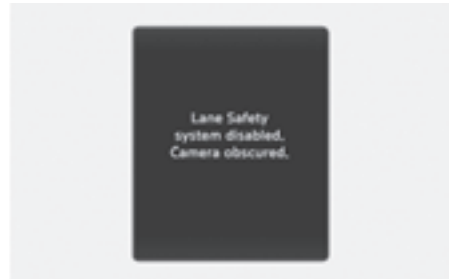

When the front windscreen where the front view camera is located, or sensor is covered with foreign material, such as snow or rain, it can reduce the detecting performance and temporarily limit or disable Lane Keeping Assist.

If this occurs, the “**Lane Safety system disabled. Camera obscured.**” warning message and the master (🚨) warning light or Lane Keeping Assist (🚦) warning light appears on the instrument cluster. But, it is not a malfunction.

Lane Keeping Assist operates properly when snow, rain or foreign material is removed.

If Lane Keeping Assist does not operate properly after it is removed, we recommend that your vehicle be inspected by a HYUNDAI authorised repairer.



### WARNING

- Even though the warning message does not appear on the instrument cluster, Lane Keeping Assist may not properly operate.
- If the vehicle is turned off and restarted whilst the camera is blocked or malfunctioned, the condition is maintained. Therefore, Lane Keeping Assist may not operate properly.

---

### Limitations of Lane Keeping Assist

Lane Keeping Assist may not operate properly or may operate unexpectedly under the following circumstances:

- The lane is contaminated or difficult to detect because:
  - The lane markings (or road edge) are covered with rain, snow, dirt, oil, etc.
  - The colour of the lane marking (or road edge) is not distinguishable from the road
  - There are markings (or road edges) on the road near the lane or the markings (or road edges) on the road look similar to the lane markings (or road edge)
  - The lane marking (or road edge) is indistinct or damaged

- The shadow is on the lane marking (or road edge) by a median strip, trees, guardrail, noise barriers, etc.
- The lane number increases or decreases, or the lane markings (or road edges) are crossing
- There are more than two lane markings (or road edges) on the road
- The lane markings (or road edges) are complicated or a structure substitutes for the lines, such as a construction area
- There are road markings, such as zigzag lanes, crosswalk markings and road signs
- The lane suddenly disappears, such as at the intersection
- The lane (or road width) is very wide or narrow
- There is a road edge without a lane
- There is a boundary structure in the roadway, such as a tollgate, sidewalk, kerb, etc.
- The distance to the front vehicle is extremely short or the vehicle in front is covering the lane marking (or road edge)

### *i* Information

For more information on the limitations of the front view camera, refer to the “Forward Collision-Avoidance Assist (FCA) (Sensor fusion)” section in this chapter.

---

 **WARNING**

Take the following precautions when using Lane Keeping Assist:

- The driver has the responsibility to safely drive and control the vehicle. Do not solely rely on Lane Keeping Assist and drive dangerously.
  - The operation of Lane Keeping Assist can be cancelled or not work properly depending on road conditions and surroundings. Always be cautious whilst driving.
  - Refer to “Limitations of Lane Keeping Assist” if the lane is not detected properly.
  - When you are towing a trailer or another vehicle, turn off Lane Keeping Assist for safety reasons.
  - If the vehicle is driven at high speed, the steering wheel will not be controlled. The driver must always follow the speed limit when using Lane Keeping Assist.
  - If any other system’s warning message appears or audible warning is generated, Lane Keeping Assist warning message may not be displayed and audible warning may not be generated.
- You may not hear the warning sound of Lane Keeping Assist if the surrounding is noisy.
  - If you attach objects to the steering wheel, steering may not be assisted properly.
  - Lane Keeping Assist may not operate for 15 seconds after the vehicle is started, or the front view camera is initialized.
  - Lane Keeping Assist will not operate when:
    - Within a certain period of time after turning on or off the turn signal or hazard warning flasher.
    - The vehicle is not driven in the centre of the lane when Lane Keeping Assist is turned on or right after changing a lane.
    - ESC (Electronic Stability Control) or VSM (Vehicle Stability Management) is activated.
    - The vehicle is driven on a sharp curve.
    - Vehicle speed is below 55 km/h (35 mph) or above 210 km/h (130 mph).
    - The vehicle makes sudden lane changes.
    - The vehicle brakes suddenly.
-

## Blind-Spot Collision-Avoidance Assist (BCA)

 if equipped

Blind-Spot Collision-Avoidance Assist detects approaching vehicles in the driver's blind spot areas and warn you of a possible collision with a warning light and a warning sound.

If there is a collision risk when exiting a parallel space, Blind-Spot Collision-Avoidance Assist may assist with braking your vehicle to help avoid a collision.

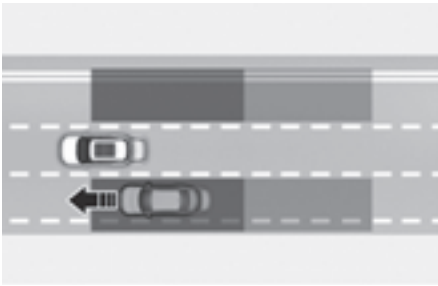

Blind-Spot Collision-Avoidance Assist helps detect and informs the driver that a vehicle is in the blind spot.

### CAUTION

The detecting range may vary depending on the speed of your vehicle. Even if there is a vehicle in the blind spot area, Blind-Spot Collision-Avoidance Assist may not warn you when you pass by at high speeds.

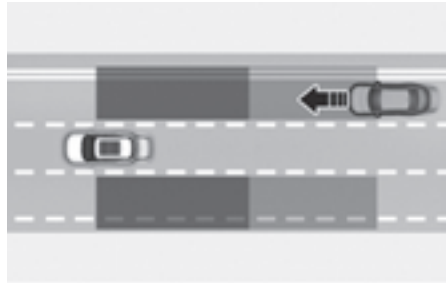

Blind-Spot Collision-Avoidance Assist helps detect and informs the driver that a vehicle is approaching at high speed from the blind spot area.

### CAUTION

Warning timing may vary depending on the speed of the vehicle approaching at high speed.

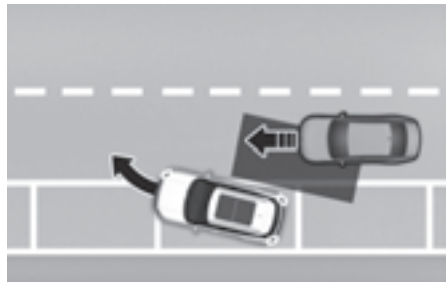

When you are driving forward out of a parking space, if Blind-Spot Collision-Avoidance Assist judges that there is a collision risk with an approaching vehicle in the blind spot, it can help avoid collision by applying the brake.

## Detecting sensor



[A] Rear corner radar

Refer to the picture above for the detailed location of the detecting sensors.

### CAUTION

Take the following precautions to maintain optimal performance of the detecting sensor:

- Never disassemble the detecting sensor assembly, or cause any damage to it.
  - If the rear corner radar or near the radar has been damaged or impacted in any way, even though the warning message does not appear on the cluster, Blind-Spot Collision Avoidance Assist may not operate properly. We recommend that your vehicle be inspected by a HYUNDAI authorised repairer.
  - If the rear corner radars have been replaced or repaired, we recommend that your vehicle be inspected by a HYUNDAI authorised repairer.
  - Use only genuine parts to repair the rear bumper where the rear corner radar is located.
- 
- Rear bumper genuine parts with rear corner radars have proven their performance. Replacing or painting the rear bumper may result in poor performance of Blind-Spot Collision Avoidance Assist. When the parts need to be replaced or modified, make sure to use qualified products.
  - Do not apply license plate frame or objects, such as a bumper sticker, film or a bumper guard near the rear corner radar.
  - Blind-Spot Collision Avoidance Assist may not work properly if the bumper has been replaced, or the surroundings of the rear corner radar have been damaged or paint has been applied.
  - If a trailer, carrier, etc., is installed, it may adversely affect the performance of the rear corner radar or Blind-Spot Collision Avoidance Assist may not operate.

## Blind-Spot Collision-Avoidance Assist settings

### Blind-spot safety



With the vehicle on, select **User settings** > **Driver assistance** > **Driving safety** > **Blind-spot safety** from the settings menu in the instrument cluster or **Settings** > **Vehicle** > **Driver assistance** > **Driving safety** > **Blind-spot safety** from the settings menu to set whether to use each function.

- If “**Blind-spot safety**” is selected, Blind-Spot Collision Avoidance Assist warns the driver with a warning message, an audible warning depending on the collision risk levels. Braking assist is applied for parking exit depending on the collision risk levels.

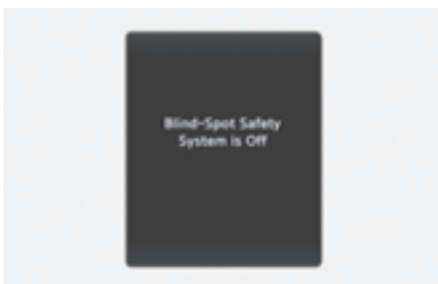

When the vehicle is restarted with Blind-Spot Collision-Avoidance Assist off, the “**Blind-Spot Safety System is Off**” message will appear on the instrument cluster.

If you select “**Blind-spot safety**”, warning light on the outside rearview mirror will blink for three seconds. In addition, if the vehicle is turned on, when “**Blind-spot safety**” is selected, the warning light on the outside rearview mirror blinks for three seconds.

### **WARNING**

The driver should always be aware of the surroundings and drive safely. If “**Blind-spot safety**” is deselected, Blind-spot Collision Avoidance Assist cannot assist you.

### **Information**

If the vehicle is restarted, Blind-Spot Collision-Avoidance Assist maintains the last setting.

## Warning methods

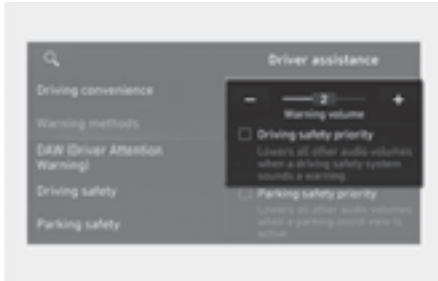

The Warning methods can be set with the vehicle on.

- **Warning volume:** Select **User settings > Driver assistance > Warning methods > Warning volume** from the settings menu in the instrument cluster or **Settings > Vehicle > Driver assistance > Warning methods > Warning volume** from the settings menu in the infotainment system to change the warning volume.
- **Driving safety priority:** Select **Settings > Vehicle > Driver assistance > Warning methods > Driving safety priority** from the settings menu in the infotainment system.

If **Driving safety priority** is selected, the vehicle lowers all other audio volumes when the warning sounds for safe driving.

### *i* Information

- If you change the **Warning methods**, the warning methods of other driver assistance systems may change.
- If the vehicle is restarted, **Warning methods** maintains the last setting.

## Blind-Spot Collision-Avoidance Assist operation

### Collision Warning



To warn the driver a vehicle is detected, the warning light on the outside rearview mirror and instrument cluster illuminates.

- Vehicle detection operates when your vehicle speed is above 20 km/h (12 mph) and the speed of the vehicle in the blind spot area is above 10 km/h (7 mph).

Collision warning operates when the turn signal is turned on in the direction of the detected vehicle.

- To warn the driver of a collision, the warning light on the outside rearview mirror and instrument cluster blinks. At the same time, an audible warning sounds.
- When the turn signal is turned off or you move away from the lane, the collision warning is cancelled and Blind-Spot Collision Avoidance Assist returns to vehicle detection state.

Collision warning operates under following conditions:

- Your vehicle speed: above 40 km/h (25 mph)
- Vehicle in the blind spot area: above 10 km/h (7 mph)

### WARNING

- The detecting range of the rear corner radar is determined by a standard road width, therefore, on a narrow road, Blind-Spot Collision-Avoidance Assist may detect other vehicles two lanes over and warn you. In contrast, on a wide road, Blind-Spot Collision-Avoidance Assist may not be able to detect a vehicle driving in the next lane and may not warn you.
- When the hazard warning flasher is on, the collision warning by the turn signal will not operate.

### Information

If the driver's seat is on the left side, the collision warning may occur when you turn left. Maintain a proper distance with the vehicles in the left lane. If the driver's seat is on the right side, the collision warning may occur when you turn right. Maintain a proper distance with the vehicles in the right lane.

The images and colours in the instrument cluster may differ depending on the cluster type or theme selected from the settings menu.

### **Collision-avoidance assist (whilst parallel parking exit)**



- To warn the driver of a collision, the warning light on the outside rearview mirror will blink and a warning message will appear on the instrument cluster. At the same time, an audible warning will sound.
- Emergency braking will be assisted to help prevent collision with the vehicle in the blind spot area.
- Blind-Spot Collision-Avoidance Assist will operate when your vehicle speed is below 3 km/h (2 mph) and the speed of the vehicle in the blind spot area is above 5 km/h (3 mph).

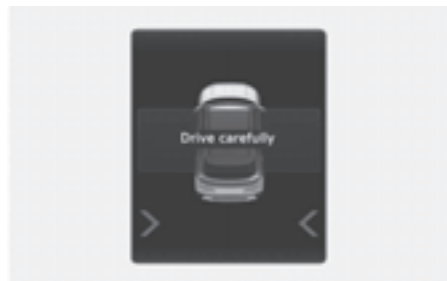

- When the vehicle is stopped due to emergency braking, the '**Drive carefully**' warning message will appear on the cluster.

For your safety, the driver should depress the brake pedal immediately and check the surroundings.



- Brake control will end after the vehicle is stopped by emergency braking for about 2 seconds.

### WARNING

Take the following precautions when using Blind-Spot Collision-Avoidance Assist:

- For your safety, only change the Settings after parking the vehicle at a safe location.
- If any other system's warning message appears or audible warning is generated, Blind-Spot Collision-Avoidance Assist's warning message may not be displayed and audible warning may not be generated.
- You may not hear the warning sound of Blind-Spot Collision-Avoidance Assist if the surrounding is noisy.
- Blind-Spot Collision-Avoidance Assist may not operate if the driver applies the brake pedal to avoid a collision.
- When Blind-Spot Collision-Avoidance Assist is operating, braking control by the function will automatically cancel when the driver excessively depresses the accelerator pedal or sharply steers the vehicle.
- During Blind-Spot Collision-Avoidance Assist operation, the vehicle may stop suddenly injuring passengers and shifting loose objects. Always have the seat belt on and keep loose objects secured.
- Even if there is a problem with Blind-Spot Collision-Avoidance Assist, the vehicle's basic steering and braking performance will operate properly.
- Blind-Spot Collision-Avoidance Assist does not operate in all situations and cannot avoid all collisions.
- Blind-Spot Collision-Avoidance Assist may warn the driver late or may not warn the driver depending on the road and driving conditions.

- Driver should maintain control of the vehicle at all times. Do not depend on Blind-Spot Collision-Avoidance Assist. Maintain a safe braking distance, and if necessary, depress the brake pedal to reduce driving speed or to stop the vehicle.
- Never operate Blind-Spot Collision-Avoidance Assist on people, animal, objects, etc. It may cause serious injury or death.

### WARNING

The brake control may not operate properly depending on the status of ESC (Electronic Stability Control).

There will only be a warning when:

- The ESC (Electronic Stability Control) warning light is on
- ESC (Electronic Stability Control) is engaged in a different function

## Blind-Spot Collision-Avoidance Assist malfunction and limitations

### **Blind-Spot Collision-Avoidance Assist malfunction**



When Blind-Spot Collision-Avoidance Assist is not working properly, the “**Check Blind-Spot Safety system.**” warning message will appear on the instrument cluster for several seconds, and the master (🚗) warning light will appear on the instrument cluster. If this occurs, we recommend that your vehicle be inspected by a HYUNDAI authorised repairer.



When the outside rearview mirror warning light is not working properly, the “**Check side view warning light**” warning message will appear on the instrument cluster for several seconds, and the master (🚗) warning light will appear on the instrument cluster. If this occurs, we recommend that your vehicle be

inspected by a HYUNDAI authorised repairer.

### **Blind-Spot Collision-Avoidance Assist disabled**



When the rear bumper around the rear corner radar or sensor is covered with foreign material, such as snow or rain, or installing a trailer or carrier, it can reduce the detecting performance and temporarily limit or disable Blind-Spot Collision-Avoidance Assist.

If this occurs, the “**Blind-Spot Safety system disabled. Radar blocked.**” warning message will appear on the cluster.

Blind-Spot Collision-Avoidance Assist will operate properly when such foreign material or trailer, etc., is removed, and then the vehicle is restarted.

If Blind-Spot Collision-Avoidance Assist does not operate properly after it is removed, we recommend that your vehicle be inspected by a HYUNDAI authorised repairer.

## WARNING

- Even though the warning message does not appear on the instrument cluster, Blind-Spot Collision-Avoidance Assist may not properly operate.
- Blind-Spot Collision-Avoidance Assist may not properly operate in an area (for example, open terrain) where any objects are not detected right after the vehicle is turned on, or when the detecting sensor is blocked with foreign material right after the vehicle is turned on.

## CAUTION

Turn off Blind-Spot Collision-Avoidance Assist to install or remove a trailer, carrier, or another attachment. Turn on Blind-Spot Collision-Avoidance Assist when finished.

### ***Limitations of Blind-Spot Collision-Avoidance Assist***

Blind-Spot Collision-Avoidance Assist may not operate properly, or it may operate unexpectedly under the following circumstances:

- There is inclement weather, such as heavy snow, heavy rain, etc.
- The rear corner radar is covered with snow, rain, dirt, etc.
- The rear corner radar or the area near the rear corner radar is blocked by a vehicle, wall, or pillar
- The temperature around the rear corner radar is high or low
- You are driving on a highway access road or through a tollbooth
- Driving on a highway ramp
- The road pavement (or the peripheral ground) abnormally contains metallic components (for example, possibly due to subway construction)
- There is a fixed object near the vehicle, such as sound barriers, guardrails, central dividers, entry barriers, street lamps, signs, tunnels, walls, etc. (including double structures)
- Driving in vast areas where there are few vehicles or structures (for example, desert, meadow, suburb, etc.)
- Driving through a narrow road where trees or grass are overgrown
- Driving on a wet road surface, such as a puddle on the road
- The other vehicle drives very close behind your vehicle, or the other vehicle passes by your vehicle in close proximity
- The speed of the other vehicle is very fast that it passes by your vehicle in a short time
- Your vehicle passes by the other vehicle
- Your vehicle changes lane
- Your vehicle has started at the same time as the vehicle next to you and has accelerated
- The vehicle in the next lane moves two lanes away from you, or when the vehicle two lanes away moves to the next lane from you
- A trailer, carrier or other attachment is installed around the rear corner radar
- The bumper around the rear corner radar is covered with objects, such as a bumper sticker, bumper guard, bike rack, etc.
- The bumper around the rear corner radar is impacted, damaged or the radar is out of position
- Your vehicle height is low or high due to heavy loads, abnormal tyre pressure, etc.

Blind-Spot Collision-Avoidance Assist may not operate properly, or it may operate unexpectedly when the following objects are detected:

- A motorcycle or bicycle is detected
- A vehicle such as a flat trailer is detected
- A big vehicle such as a bus or truck is detected
- A moving obstacle such as a pedestrian, animal, shopping cart or a baby stroller is detected
- A vehicle with low height such as a sports car is detected

Braking control may not work, driver's attention is required in the following circumstances:

- The vehicle severely vibrates whilst driving over a bumpy road, uneven road or concrete patch
- Driving on a slippery surface due to snow, water puddle, ice, etc.
- The tyre pressure is low or a tyre is damaged
- The braking system has been modified
- The vehicle makes abrupt lane changes

### **i** Information

For more information on the limitations of the front view camera, refer to "Forward Collision-Avoidance Assist (FCA) (Sensor fusion)" section in this chapter.

### **!** WARNING

- **Driving on a curved road**



Blind-Spot Collision-Avoidance Assist may not operate properly when driving on a curved road. The function may not detect the vehicle in the next lane.

Always pay attention to road and driving conditions whilst driving.



Blind-Spot Collision-Avoidance Assist may not operate properly when driving on a curved road. The function may recognise a vehicle in the same lane.

Always pay attention to road and driving conditions whilst driving.

- Driving on an inclined road

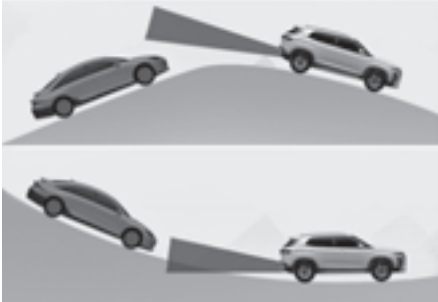

Blind-Spot Collision-Avoidance Assist may not operate properly when driving on a slope. The function may not detect the vehicle in the next lane or may incorrectly detect the ground or structure. Always pay attention to road and driving conditions whilst driving.

- Driving where the road is merging/dividing



Blind-Spot Collision-Avoidance Assist may not operate properly when driving where the road merges or divides. The function may not detect the vehicle in the next lane.

Always pay attention to road and driving conditions whilst driving.

- Driving where the heights of the lanes are different

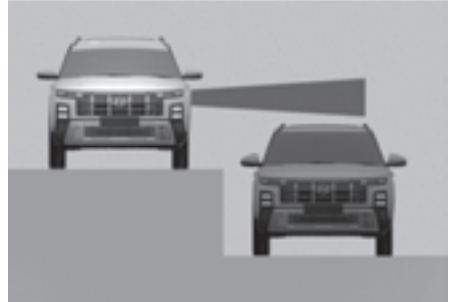

Blind-Spot Collision-Avoidance Assist may not operate properly when driving where the heights of the lanes are different. The function may not detect the vehicle on a road with different lane heights (underpass joining section, grade separated intersections, etc.). Always pay attention to road and driving conditions whilst driving.

### WARNING

- When you are towing a trailer or another vehicle, make sure that you turn off Blind-Spot Collision-Avoidance Assist.
- Blind-Spot Collision-Avoidance Assist may not operate properly if interfered by strong electromagnetic waves.
- Blind-Spot Collision-Avoidance Assist may not operate for about 3 seconds after the vehicle is started, or the rear corner radars are initialized.

## Safe Exit Warning (SEW)

 If equipped

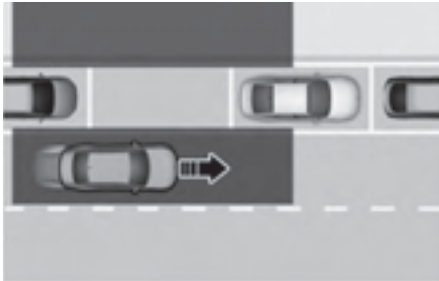

Whilst your vehicle is stopped, and if Safe Exit Warning detects a vehicle approaching the rear corner of your vehicle and a passenger opens a door, Safe Exit Warning may warn you with a warning message and a warning sound to help avoid a collision.

### CAUTION

Warning timing may vary depending on the speed of the approaching vehicle.

### Detecting sensor



[A] Rear corner radar

Refer to the illustration above for the detailed location of the detecting sensors.

### CAUTION

For more information on the precautions of the rear corner radars, refer to the “Blind-Spot Collision-Avoidance Assist (BCA)” section in this chapter.

## Safe Exit Warning settings

### Safe Exit Warning

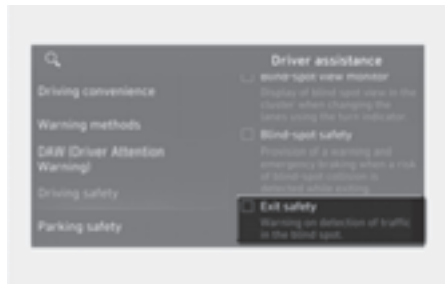

With the vehicle on, select **User settings** > **Driver assistance** > **Driving safety** > **Exit safety** from the settings menu in the instrument cluster or **Settings** > **Vehicle** > **Driver assistance** > **Driving safety** > **Exit safety** from the settings menu to turn on Safe Exit Warning and deselect to turn off the function.

### WARNING

The driver should always be aware of his or her surroundings. If “**Exit safety**” is deselected, Safe Exit Warning cannot assist you.

### Information

If the vehicle is restarted, Safe Exit Warning will maintain the last setting.

## Warning methods

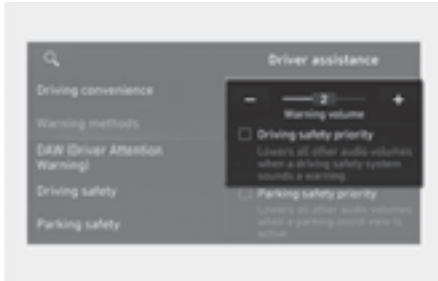

The Warning methods can be set with the vehicle on.

- **Warning volume:** Select **User settings > Driver assistance > Warning methods > Warning volume** from the settings menu in the instrument cluster or **Settings > Vehicle > Driver assistance > Warning methods > Warning volume** from the settings menu in the infotainment system to change the warning volume.
- **Driving safety priority:** Select **Settings > Vehicle > Driver assistance > Warning methods > Driving safety priority** from the settings menu in the infotainment system.

If **Driving safety priority** is selected, the vehicle lowers all other audio volumes when the warning sounds for safe driving.

### *i* Information

- If you change the **Warning methods**, the warning methods of other driver assistance systems may change.
- If the vehicle is restarted, **Warning methods** will maintain the last setting.
- The setting menu may not exist based on vehicle specification.

## Safe Exit Warning operation

### Safe Exit Warning

#### Collision warning when exiting vehicle



- When an approaching vehicle from the rear is detected at the moment a door is opened, the '**Collision Warning**' warning message will appear on the cluster, and the warning light on the outside rearview mirrors blinks. At the same time, an audible warning will sound.
- Safe Exit Warning will warn the driver when your vehicle speed is below 3 km/h (2 mph), and the speed of the approaching vehicle from the rear is above 6 km/h (4 mph).

### WARNING

Take the following precautions when using Safe Exit Warning:

- For your safety, change the Settings after parking the vehicle at a safe location.
- If any other system's warning message appears or audible warning is generated, Safe Exit Warning's warning message may not be displayed and audible warning may not be generated.
- You may not hear the warning sound of Safe Exit Warning if the surrounding is noisy.
- Safe Exit Warning does not operate in some situations or cannot prevent all collisions.
- Safe Exit Warning may warn the driver late or may not warn the driver depending on the road and driving conditions. Always check vehicle surroundings.
- The driver and passengers are responsible for accidents that occurs whilst exiting the vehicle. Always check the surroundings before you exit the vehicle.

### Information

- After the vehicle is turned off, Safe Exit Warning operates for about 3 minutes, but turns off immediately if the doors are locked.
- The images and colours in the cluster may differ depending on the cluster type or theme selected from the cluster.

## Safe Exit Warning malfunction and limitations

### Safe Exit Warning malfunction

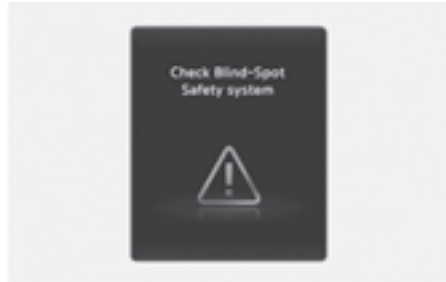

When Safe Exit Warning is not working properly, the **“Check Blind-Spot Safety system”** warning message will appear on the cluster for several seconds, and the master warning light () will appear on the cluster. If this occurs, we recommend that your vehicle be inspected by a HYUNDAI authorised repairer.



When the outside rearview mirror warning light is not working properly, the **“Check side view mirror warning light”** warning message will appear on the cluster for several seconds, and the master warning light () will appear on the cluster. If this occurs, we recommend that your vehicle be inspected by a HYUNDAI authorised repairer.



## Safe Exit Warning disabled

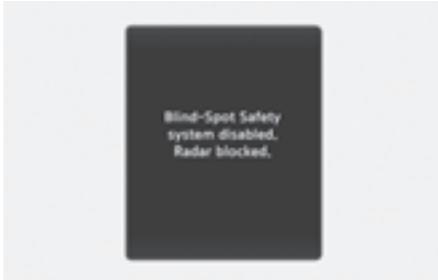

When the rear bumper around the rear corner radar or sensor is covered with foreign material, such as snow or rain, or installing a trailer or carrier, it can reduce the detecting performance and temporarily limit or disable Safe Exit Warning.

If this occurs, the **“Blind-Spot Safety system disabled. Radar blocked.”** warning message will appear on the cluster. But, it is not a malfunction.

Safe Exit Warning will operate properly when such foreign material or trailer, etc., is removed, and then the vehicle is restarted.

If Safe Exit Warning does not operate properly after it is removed, we recommend that your vehicle be inspected by a HYUNDAI authorised repairer.

### WARNING

- Even though the warning message does not appear on the cluster, Safe Exit Warning may not properly operate.
- Safe Exit Warning may not properly operate in an area (for example, open terrain) where any objects are not detected right after the vehicle is turned on, or when the detecting sensor is blocked with foreign material right after the vehicle is turned on.

### CAUTION

Turn off Safe Exit Warning to install or remove a trailer, carrier, or another attachment. Turn on Safe Exit Warning when finished.

### **Limitations of Safe Exit Warning**

Safe Exit Warning may not operate properly, or it may operate unexpectedly under the following circumstances:

- Getting out of the vehicle where trees or grass are overgrown
- Getting out of the vehicle where the road is wet
- The approaching vehicle is very fast or very slow

### Information

For more information on the limitations of the rear corner radar, refer to the “Blind-Spot Collision-Avoidance Assist (BCA)” section in this chapter.

### WARNING

- Safe Exit Warning may not operate properly if interfered by strong electromagnetic waves.
- Safe Exit Warning may not operate for about 3 seconds after the vehicle is started, or the rear corner radars are initialized.
- If the vehicle is turned off and restarted whilst the radar is blocked or malfunctioned, the condition is maintained. Therefore, Safe Exit Warning may not operate properly.

## Manual Speed Limit Assist (MSLA)

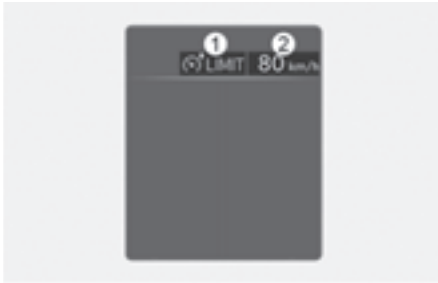

- (1) Speed Limit indicator
- (2) Set speed

You can set the speed limit when you do not want to drive over a specific speed. If you drive over the preset speed limit, Manual Speed Limit Assist will operate (set speed limit will blink and chime will sound) until the vehicle speed returns within the speed limit.

### Manual Speed Limit Assist operation

#### Setting speed limit

1. Press and hold the Driving Assist (DA) button at the desired speed. The Speed Limit (LIMIT) indicator will appear on the cluster.



2. Push the + switch up or - switch down, and release it at the desired speed.

Push the + switch up or - switch down and hold it. The speed will increase or decrease to the nearest multiple of 10 in km/h (5 mph) at first, and then increase or decrease by 10 km/h (5 mph).



3. The set speed limit will be displayed on the cluster.

If you would like to drive over the preset speed limit, depress the accelerator pedal beyond the pressure point to activate the kickdown function.

The set speed limit will blink and chime will sound until you return the vehicle speed within the speed limit.





#### *i* Information

When the accelerator pedal is not depressed beyond the pressure point, vehicle speed will maintain within the speed limit.

### Temporarily pausing Manual Speed Limit Assist



Press the  switch to temporarily pause the set speed limit. The set speed limit will turn off but the Speed Limit () indicator will stay on.

### Resuming Manual Speed Limit Assist





To resume Manual Speed Limit Assist after the function was paused, operate the +, -,  switch.

If you push the + switch up or -switch down, vehicle speed will be set to the current speed on the cluster.

If you press the  switch, vehicle speed will resume to the preset speed.

### Turning off Manual Speed Limit Assist



Press the Driving Assist () button to turn Manual Speed Limit Assist off. The Speed Limit () indicator will go off.

Always press the Driving Assist () button to turn Manual Speed Limit Assist off when not in use.

### WARNING

Take the following precautions when using Manual Speed Limit Assist:

- Always set the vehicle speed to the speed limit in your country.
- Keep Manual Speed Limit Assist off when the function is not in use, to avoid inadvertently setting a speed. Check that the Speed Limit () indicator is off.
- Manual Speed Limit Assist does not substitute for proper and safe driving. It is the responsibility of the driver to always drive safely and be aware of unexpected and sudden situations. Pay attention to the road conditions at all times.

## Driver Attention Warning (DAW)

 If equipped

### **Inattentive driving warning function**

Driver Attention Warning monitors your driving pattern whilst driving. When the driver's attention level is below a certain level, Driver Attention Warning recommends a break to help with safe driving.

### **Leading vehicle departure alert function**

Leading Vehicle Departure Alert function will inform the driver when a detected vehicle in front departs.

### **Detecting sensor**



[A] Front view camera

The front view camera is used as a detecting sensor to help detect driving patterns and front vehicle departure whilst vehicle is being driven.

See the illustration above for the detailed location of the detecting sensor.

## CAUTION

- Always keep the front view camera in good condition to maintain optimal performance of Driver Attention Warning.
- For more information on the precautions of the front view camera, refer to the “Forward Collision-Avoidance Assist (FCA) (Sensor fusion)” section in this chapter.

## Driver Attention Warning settings

### **Leading vehicle departure alert**

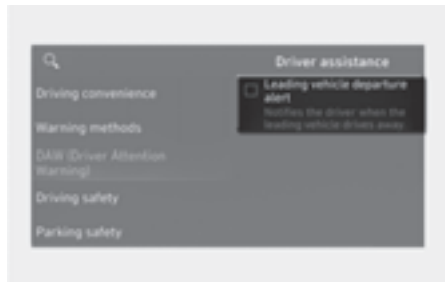

With the vehicle on, select **User settings > Driver assistance > DAW (Driver Attention Warning) > Leading vehicle departure alert** from the settings menu in the instrument cluster or **Settings > Vehicle > Driver assistance > DAW (Driver Attention Warning)** and then enable **Leading vehicle departure alert** in the infotainment system to use the function.

If **Leading vehicle departure alert** is enabled, the function informs the driver when a detected vehicle in front departs from a stop.

## Driver Attention Warning operation

### ***Inattentive driving warning function***

The basic function of Driver Attention Warning is to warn the driver “**Consider taking a break**”.

#### Taking a break



The “**Consider taking a break**” message will appear and the inattentive driving (☹️) warning light will blink on the cluster with a warning sound to suggest that the driver take a break, when the driver’s attention level is below a certain level.

- Driver Attention Warning will not suggest a break when the total driving time is shorter than 4 minutes or 4 minutes has not passed after the last break was suggested.

### **! WARNING**

For your safety, change the Settings after parking the vehicle at a safe location.

### **! CAUTION**

- Driver Attention Warning may suggest a break depending on the driver’s driving pattern or habits, even if the driver doesn’t feel fatigue.
- Driver Attention Warning is a supplemental function and may not be able to determine whether the driver is inattentive.
- A driver who feels fatigued should take a break at a safe location, even though there is no break suggestion by Driver Attention Warning.

### **i Information**

For more information on instrument cluster settings, refer to the “4-29” section in chapter 4.

### ***Leading Vehicle Departure Alert function***

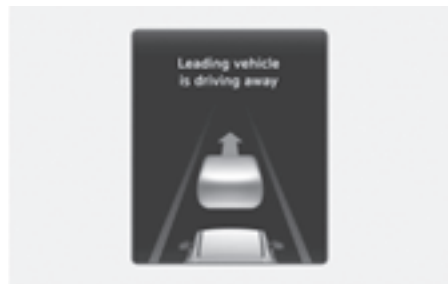

When a detected vehicle in front departs from a stop, Leading Vehicle Departure Alert will inform the driver by displaying the “**Leading vehicle is driving away**” message on the instrument cluster and an audible warning will sound.

### WARNING

- If any other system's warning message appears or audible warning is generated, Leading Vehicle Departure Alert's warning message may not be displayed and audible warning may not be generated.
  - The driver has the responsibility to safely drive and control the vehicle.
- 

### CAUTION

- Leading Vehicle Departure Alert is a supplemental function and may not alert the driver whenever the front vehicle departs from a stop.
  - Always check the front of the vehicle and road conditions before departure.
- 

### Information

The images and colours in the instrument cluster may differ depending on the cluster type or theme selected from the settings menu.

---

## Driver Attention Warning malfunction and limitations

### *Driver Attention Warning malfunction*



When Driver Attention Warning is not working properly, the “**Check Inattentive Driving Warning system**” warning message will appear on the cluster for several seconds, and the master (🚗) warning light and the inattentive driving (☹️) warning light will appear on the instrument cluster. If this occurs, we recommend that your vehicle be inspected by a HYUNDAI authorised repairer.

### Driver Attention Warning disabled



When the front windscreen where the front view camera is located is covered with foreign material, such as snow or rain, it can reduce the detecting performance and temporarily limit or disable Driver Attention Warning. If this occurs, the **“Inattentive Driving Warning disabled. Camera obscured.”** warning message, the master (A) warning light, and the inattentive driving (B) warning light will appear on the instrument cluster. But, it is not a malfunction. Driver Attention Warning will operate properly when driving after snow, rain or foreign material is removed. If Driver Attention Warning does not operate properly after it is removed, we recommend that your vehicle be inspected by a HYUNDAI authorised repairer.

#### WARNING

- Driver Attention Warning may not properly operate in an area (for example, open terrain) where any objects are not detected right after turning ON the vehicle.
- If the vehicle is turned off and restarted whilst the camera is blocked or malfunctioned, the condition is maintained. Therefore, Driver Attention Warning may not operate properly.

### Limitations of Driver Attention Warning

Driver Attention Warning may not work properly in the following situations:

- The vehicle is driven violently
- The vehicle intentionally crosses over lanes frequently
- The vehicle is controlled by Driver Assistance system, such as Lane Keeping Assist
- Lanes are blurred or erased

### Leading Vehicle Departure Alert function

- **When the vehicle cuts in**

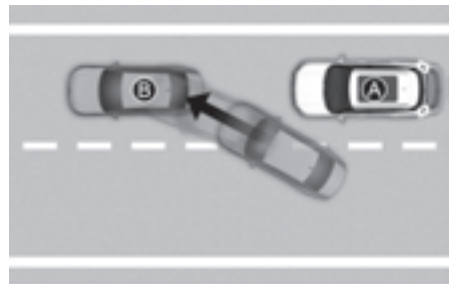
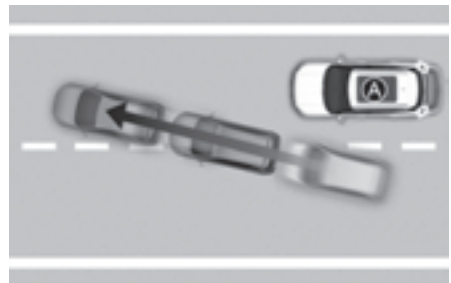

[A] Your vehicle  
[B] Front vehicle

If a vehicle cuts in front of your vehicle, Leading Departure Alert may not operate properly.

- **When the vehicle ahead sharply steers**

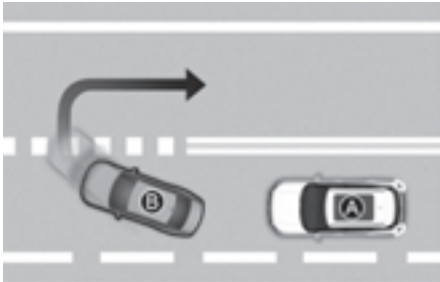

[A] Your vehicle  
[B] Front vehicle

If the vehicle in front makes a sharp turn, such as to turn left or right or make a U- turn, etc., Leading Vehicle Departure Alert may not operate properly.

- **When the vehicle ahead abruptly departs**

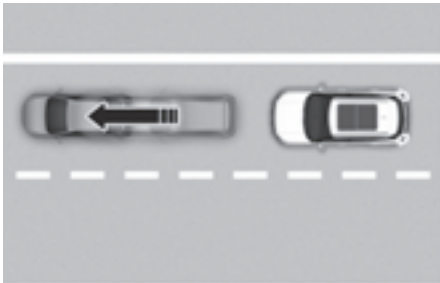

If the vehicle in front abruptly departs, Leading Vehicle Departure Alert may not operate properly.

- **When a pedestrian or bicycle is between you and the vehicle ahead**



If there is a pedestrian(s) or bicycle(s) in between you and the vehicle in front, Leading Vehicle Departure Alert may not operate properly.

- **When in a parking lot**

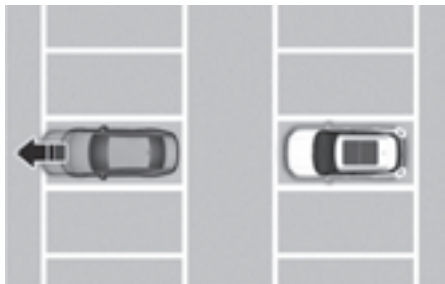

If a vehicle parked in front drives away from you, Leading Vehicle Departure Alert may alert you that the parked vehicle is driving away.



- When driving at a tollgate or intersection, etc.



If you pass a tollgate or intersection with lots of vehicles or you drive where lanes are merged or divided frequently, Leading Vehicle Departure Alert may not operate properly.

### WARNING

Driver Attention Warning may not operate for about 15 seconds after the vehicle is started, or the front view camera is initialized.

### Information

For more information on the precautions of the front view camera, refer to the “Forward Collision-Avoidance Assist (FCA) (Sensor fusion)” section in this chapter.

## Blind-Spot View Monitor (BVM)

 if equipped



Blind-Spot View Monitor uses the wide-side view cameras to display the rear blind spot areas of your vehicle on the instrument cluster when the turn signal is turned on to help with safe lane changes.

### Detecting sensor



[A] Wide-side view camera (camera located at bottom of the mirror)

See the illustration above for the detailed location of the detecting sensors.

### Blind-Spot View Monitor settings

#### Setting features

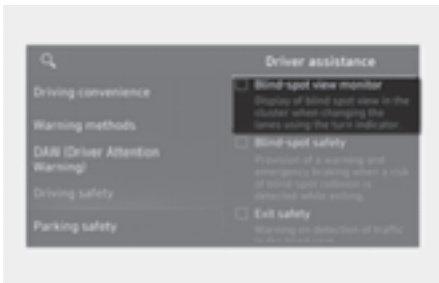

With the vehicle on, select **User settings > Driver assistance > Driving safety > Blind-spot view monitor** from the settings menu in the instrument cluster or **Settings > Vehicle > Driver assistance > Driving safety** and then enable **Blind-spot view monitor** in the infotainment system to turn on the Blind-Spot View Monitor feature.

### Blind-Spot View Monitor operation

Blind-Spot View Monitor will turn on and off when the turn signal is turned on and off.

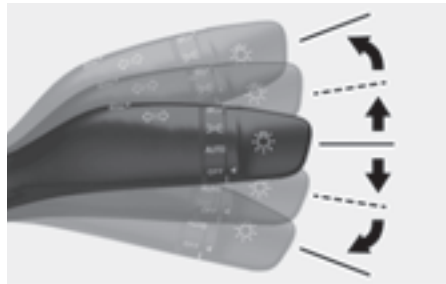

#### Operating conditions

When the left or right side turn signal turns on, the image in that direction is displayed on the instrument cluster.

#### Off conditions

- When the turn signal turns off, the image on the instrument cluster will turn off.
- When the hazard warning flasher is on, Blind-Spot View Monitor will turn off, regardless of the turn signal status.
- When other important warning is displayed on the instrument cluster, Blind-Spot View Monitor may turn off.

## Blind-Spot View Monitor malfunction

When Blind-Spot View Monitor is not working properly, or the cluster display flickers, or the camera image does not display properly, we recommend that your vehicle be inspected by a HYUNDAI authorised repairer.

### WARNING

- The image shown on the cluster may differ from the actual distance of the object. Make sure to directly check the vehicle's surroundings for safety.
- Always keep the camera lens clean. If the lens is covered with foreign material, it may adversely affect camera performance and Blind-Spot View Monitor may not operate properly.

## Cruise Control (CC)

 if equipped



- (1) Cruise indicator
- (2) Set speed

Cruise Control will allow you to drive at speeds above 30 km/h (20 mph) without depressing the accelerator pedal.

## Cruise Control operation

### Setting speed

1. Accelerate to the desired speed, which must be more than 30 km/h (20 mph).



2. Press the Driving Assist button at the desired speed. The set speed and Cruise () indicator will illuminate on the cluster.
3. Release the accelerator pedal.  
Vehicle speed will maintain the set speed even when the accelerator pedal is not depressed.

## **i** Information

- The vehicle may slightly slow down or speed up whilst driving uphill or downhill.
- The Driving Assist button symbol may vary depending on your vehicle option.

### **Increasing set speed**



- Push the + switch up and release it immediately. The set speed will increase by 1km/h (1mph) each time the switch is operated in this manner.
- Push the + switch up and hold it whilst monitoring the set speed on the cluster. The set speed will increase to the nearest multiple of 10 in km/h (5 mph) at first, and then increase by 10 km/h (5 mph) each time the switch is operated in this manner.

Release the switch when the desired speed is shown and the vehicle will accelerate to that speed.

### **Decreasing set speed**



- Push the - switch down and release it immediately. The set speed will decrease by 1km/h (1mph) each time the switch is operated in this manner.
- Push the - switch down and hold it whilst monitoring the set speed on the cluster. The set speed will decrease to the nearest multiple of five (multiple of ten in km/h) at first, and then decrease by 5 mph (10 km/h) each time the switch is operated in this manner. Release the switch at the speed you want to maintain.

### **Accelerating temporarily**

If you want to speed up temporarily when Cruise Control is on, depress the accelerator pedal.

To return to the set speed, take your foot off the accelerator pedal.

If you push the + switch up or - switch down at increased speed, the set speed will be set to the current increased speed.

### Temporarily pausing Cruise Control



Cruise Control will be paused when:

- Depressing the brake pedal.
- Pressing the  switch.
- Shifting the gear to N (Neutral).
- Decreasing vehicle speed to less than about 30 km/h (20 mph).
- ESC (Electronic Stability Control) is operating.
- Downshifting to 2nd gear when in Manual Shift mode.

The set speed will turn off but the Cruise () indicator will stay on.

#### NOTICE

If Cruise Control pauses during a situation that is not mentioned, we recommend that your vehicle be inspected by a HYUNDAI authorised repairer.

### Resuming Cruise Control





Operate the +, - or  switch.

If you push the + switch up or - switch down, vehicle speed will be set to the current speed on the cluster.

If you press the  switch, vehicle speed will resume to the preset speed.

The vehicle speed must be above 30 km/h (20 mph) for Cruise Control to resume.

#### WARNING

Check the driving condition before using the  switch. Driving speed may sharply increase or decrease when you press the  switch.

### Turning off Cruise Control



Press the Driving Assist button to turn Cruise Control off. The Cruise (CC) indicator will go off.

Always press the Driving Assist button to turn Cruise Control off when not in use.

#### **i** Information

If your vehicle is equipped with Manual Speed Limit Assist, press and hold the Driving Assist button to turn off Cruise Control. However, Manual Speed Limit Assist will turn on.

---

#### **!** WARNING

Take the following precautions when using Cruise Control:

- Always set the vehicle speed under the speed limit in your country.
  - Keep Cruise Control off when the system is not in use, to avoid inadvertently setting a speed. Check that the Cruise (CC) indicator is off.
  - Cruise Control does not substitute for proper and safe driving. It is the responsibility of the driver to always drive safely and should always be aware of unexpected and sudden situations from occurring.
  - Always drive cautiously to prevent unexpected and sudden situations from occurring. Pay attention to the road conditions at all times.
  - Do not use Cruise Control when it may be unsafe to keep the vehicle at a constant speed:
    - When driving in heavy traffic, or when traffic conditions make it difficult to drive at a constant speed
    - When driving on rainy, icy, or snow-covered roads
    - When driving on hilly or windy roads
    - When driving in windy areas
    - When driving with limited view (possibly due to bad weather, such as fog, snow, rain and sandstorm)
  - Do not use Cruise Control when towing a trailer.
-

## Smart Cruise Control (SCC)

 if equipped

Smart Cruise Control detects a vehicle ahead and helps maintain the distance from the vehicle ahead and the set speed.

### **Overtaking Acceleration Assist**

When Smart Cruise Control judges you are attempting to overtake a vehicle in front, Smart Cruise Control helps with accelerating.

### **Detecting sensor**



[A] Front view camera

[B] Front radar

The front view camera and front radar are used as a detecting sensor to detect front vehicles.

See the illustration above for the detailed location of the detecting sensor.

### CAUTION

Always keep the front view camera and front radar in good condition to maintain optimal performance of Smart Cruise Control.

For more information on the precautions of the front view camera and front radar, refer to the “Forward Collision-Avoidance Assist (FCA) (Sensor fusion)” section in this chapter.

## Smart Cruise Control settings

### **Smart Cruise Control**



With the vehicle on, select **User settings > Driver assistance > Driving convenience > Smart Cruise Control** from the settings menu in the instrument cluster or **Settings > Vehicle > Driver assistance > Driving Convenience > SCC (Smart Cruise Control)** from the settings menu in the infotainment system to change Distance, Acceleration, Reaction Speed manually.

## Warning methods

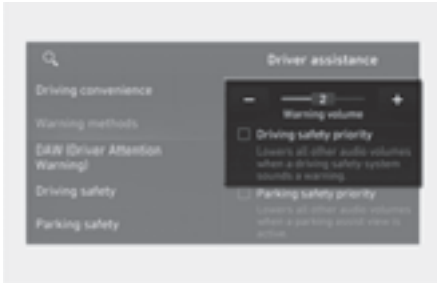

The **Warning methods** can be set with the vehicle on.

- **Warning volume:** Select **User settings > Driver assistance > Warning methods > Warning volume** from the settings menu in the instrument cluster or **Settings > Vehicle > Driver assistance > Warning methods > Warning volume** from the settings menu in the infotainment system to change the warning volume.
- **Driving safety priority:** Select **Settings > Vehicle > Driver assistance > Warning methods > Driving safety priority** from the settings menu in the infotainment system.

If **Driving safety priority** is selected, the vehicle lowers all other audio volumes when the warning sounds for safe driving.

### **i** Information

- If you change the **Warning methods**, the warning methods of other driver assistance systems may change.
- If the vehicle is restarted, **Warning methods** will maintain the last setting.
- The setting menu may not exist based on vehicle specification.

## Smart Cruise Control operation

### Operating conditions

#### Basic function

Smart Cruise Control operates when the following conditions are satisfied.

- The gear is in D (Drive)
- Your vehicle speed is within the operating speed range
  - 10-200 km/h (5-120 mph): when there is no vehicle in front
  - 0-200 km/h (0-120 mph): when there is a vehicle in front
- ESC (Electronic Stability Control) or ABS (Anti-Lock Braking System) is on

Smart Cruise Control does not operate in the following conditions.

- The driver's door is opened
- Engine RPM is high
- Parking brake is applied
- ESC (Electronic Stability Control) or ABS (Anti-Lock Braking System) is controlling the vehicle
- Forward Collision-Avoidance Assist brake control is operating

### **i** Information

When stopped behind another vehicle, the driver can turn on Smart Cruise Control whilst the brake pedal is depressed.



### Operating conditions for Acceleration Assist

Overtaking Acceleration Assist operates when the turn signal indicator is turned on to the left (left-hand drive) or turned on to the right (right-hand drive) whilst Smart Cruise Control is operating, and the following conditions are satisfied:

- Your vehicle speed is above 60 km/h (40 mph)
- A vehicle is detected in front of your vehicle

Overtaking Acceleration Assist does not operate in the following conditions.

- The hazard warning flasher is on
- Vehicle speed is reduced to maintain distance with the vehicle in front

### WARNING

- When the turn signal indicator is turned on to the left (left-hand drive) or turned on to the right (right-hand drive) whilst there is a vehicle ahead, the vehicle may accelerate temporarily. Pay attention to the road conditions at all times.
- Regardless of the driving direction in your country, Overtaking Acceleration Assist will operate when the conditions are satisfied. When using the function in countries with different driving direction, always check the road conditions at all times.

### Turning on Smart Cruise Control



- Press the Driving Assist button to turn on Smart Cruise Control. The speed will be set to the current speed on the cluster.
- If there is no vehicle in front of you, the set speed will be maintained, but if there is a vehicle in front of you, the speed may decrease to maintain the distance to the vehicle ahead. If the vehicle ahead accelerates, your vehicle will travel at a steady cruising speed after accelerating to the set speed.

### Information

- If your vehicle speed is between 0-30 km/h (0-20 mph) when you press the Driving Assist button, Smart Cruise Control speed will be set to 30 km/h (20 mph).
- If you shift from a higher gear to a lower gear using the manual shift mode or paddle shifter, the vehicle speed may not accelerate to the set speed.

### Setting vehicle distance



Press the button repeatedly to cycle through the headway settings from **Distance 4** → **Distance 3** → **Distance 2** → **Distance 1** → **Distance 4**.

If you drive at 90 km/h (56 mph), the distance is maintained as follows:

- Distance 4: about 52.5 m (172 ft.)
- Distance 3: about 40 m (130 ft.)
- Distance 2: about 32.5 m (106 ft.)
- Distance 1: about 25 m (82 ft.)

#### **i** Information

The distance is set to the last set distance when the vehicle is restarted, or when Smart Cruise Control was temporarily cancelled.

### Increasing set speed



- Push the + switch up and release it immediately. The set speed will increase by 1km/h (1mph) each time the switch is operated in this manner.
- Push the + switch up and hold it whilst monitoring the set speed on the cluster. The set speed will increase by 10 km/h (5 mph) each time the switch is operated in this manner. Release the switch when the desired speed is shown, and the vehicle will accelerate to that speed. You can increase the set speed up to 200 km/h (120 mph).

#### **!** WARNING

Check the driving condition before using the + switch. Driving speed may sharply increase when you push up and hold the + switch.

#### **i** Information

The driving speed may not reach the set speed depending on the vehicle characteristics and driving conditions.

### Decreasing set speed



- Push the - switch down and release it immediately. The set speed will decrease by 1km/h (1mph) each time the switch is operated in this manner.
- Push the - switch down and hold it whilst monitoring the set speed on the cluster. The set speed will decrease by 10 km/h (5 mph) each time the switch is operated in this manner. Release the switch at the speed you want to maintain. You can decrease the set speed to 30 km/h (20 mph).

### Temporarily cancelling Smart Cruise Control



Press the  switch or depress the brake pedal to temporarily cancel Smart Cruise Control.

### Resuming Smart Cruise Control





To resume Smart Cruise Control after the function was cancelled, operate the +, - or  switch.

If you push the + switch up or - switch down, vehicle speed will be set to the current speed on the cluster.

If you press the  switch, vehicle speed will resume to the preset speed.

#### WARNING

Check the driving condition before using the  switch. Driving speed may sharply increase or decrease when you press the  switch.

### Turning off Smart Cruise Control



To turn Smart Cruise Control off, press the Driving Assist (🚗) button.

#### **i** Information

If your vehicle is equipped with Manual Speed Limit Assist, press and hold the Driving Assist (🚗) button to turn off Smart Cruise Control. However Manual Speed Limit Assist will turn on.

#### **⚠** CAUTION

Do not use the switches and buttons at the same time. Smart Cruise Control may not operate properly.

### Display and Control

You can see the status of the Smart Cruise Control operation in the Driving Assist view on the cluster. Refer to “4-29” section in chapter 4.

Smart Cruise Control will be displayed as below depending on the status of the function.

Operating



Temporarily cancelled



- When operating
  - (1) Whether there is a vehicle ahead and the selected distance level
  - (2) Set speed
  - (3) Whether there is a vehicle ahead and the target vehicle distance
- When temporarily cancelled
  - (1) Your vehicle (grey)
  - (2) Previous set speed (grey)

## *i* Information

- The distance of the front vehicle on the cluster is displayed according to the actual distance between your vehicle and the vehicle ahead.
- The target distance may vary according to the vehicle speed and the set distance level. If the vehicle speed is low, even though the vehicle distance have changed, the change of the target vehicle distance may be small.
- The images and colours in the instrument cluster may differ depending on the cluster type or theme selected from the settings menu.

### **Accelerating temporarily**



If you want to speed up temporarily without altering the set speed whilst Smart Cruise Control is operating, depress the accelerator pedal. Whilst the accelerator pedal is depressed, the set speed, distance level and target distance will blink on the cluster.

However, if the accelerator pedal is depressed insufficiently, the vehicle may decelerate.

## WARNING

Be careful when accelerating temporarily, because the speed and distance is not controlled automatically even if there is a vehicle in front of you.

### **Temporarily cancelling Smart Cruise Control**

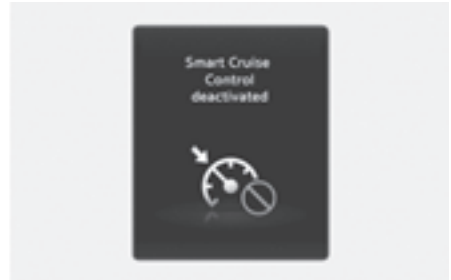

Smart Cruise Control will be temporarily cancelled automatically when:

- The vehicle speed is above 130 mph (210 km/h)
- The vehicle is stopped for a certain period of time
- The accelerator pedal is continuously depressed for a certain period of time
- The conditions for the Smart Cruise Control to operate is not satisfied

If Smart Cruise Control is temporarily cancelled automatically, the 'Smart Cruise Control' deactivated (or 'SCC (Smart Cruise Control) Cancelled') warning message will appear on the cluster, and an audible warning will sound to warn the driver.

## *i* Information

If Smart Cruise Control is temporarily cancelled whilst the vehicle is at a standstill with the function activated, EPB (Electronic Parking Brake) maybe applied.

**WARNING**

When Smart Cruise Control is temporarily cancelled, distance with the front vehicle will not be maintained. Always have your eyes on the road whilst driving, and if necessary, depress the brake pedal to reduce your driving speed in order to maintain a safe distance.

**Smart Cruise Control conditions not satisfied**

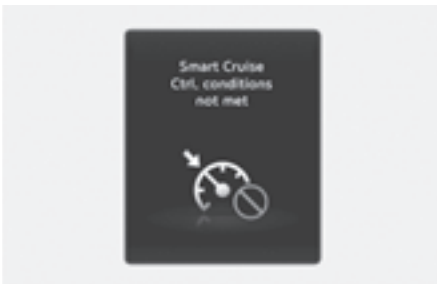

If the Driving Assist button, + switch, - switch or  switch is operated when Smart Cruise Control operating conditions are not satisfied, the Smart Cruise Control conditions not met' (or 'SCC (Smart Cruise Control) conditions not met' will appear on the cluster, and an audible warning will sound.

**In traffic situation**



In traffic, your vehicle will stop if the vehicle ahead of you stops. Also, if the vehicle ahead of you starts moving, your vehicle will start as well. In addition, after the vehicle has stopped and a certain time have passed, the 'Use switch or pedal to accelerate' message will appear on the instrument cluster. Depress the accelerator pedal or operate the + switch, - switch or  switch to start driving.

**Warning road conditions ahead**

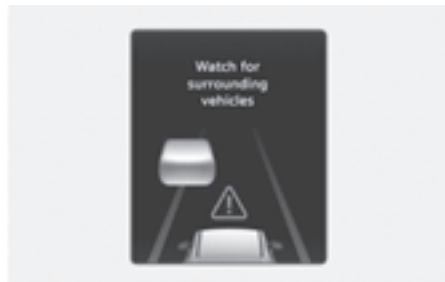

In the following situation, the 'Watch for surrounding vehicles' warning message will appear on the cluster, and an audible warning will sound to warn the driver of road conditions ahead.

- The vehicle in front disappears when Smart Cruise Control is maintaining the distance with the vehicle ahead whilst driving below a certain speed.

## WARNING

Always pay attention to vehicles or objects that may suddenly appear in front of you, and if necessary, depress the brake pedal to reduce your driving speed in order to maintain a safe distance.

### **Collision Warning**

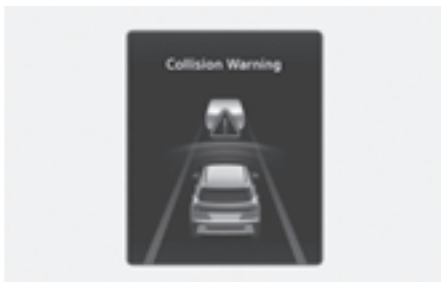

whilst Smart Cruise Control is operating, when the collision risk with the vehicle ahead is high, the 'Collision Warning' warning message will appear on the instrument cluster, and an audible warning will sound to warn the driver. Always have your eyes on the road whilst driving, and if necessary, depress the brake pedal to reduce your driving speed in order to maintain a safe distance.

## WARNING

In the following situations, Smart Cruise Control may not warn the driver of a collision.

- The distance from the front vehicle is near, or the vehicle speed of the front vehicle is faster or similar with your vehicle
- The speed of the front vehicle is very slow or is at a standstill
- The accelerator pedal is depressed right after Smart Cruise Control is turned on

## WARNING

Take the following precautions when using Smart Cruise Control:

- Smart Cruise Control does not substitute for proper and safe driving. It is the responsibility of the driver to always check the speed and distance to the vehicle ahead.
- Smart Cruise Control may not recognise unexpected and sudden situations or complex driving situations, so always pay attention to driving conditions and control your vehicle speed.
- Keep Smart Cruise Control off when the function is not in use to avoid inadvertently setting a speed.
- Do not open the door or leave the vehicle when Smart Cruise Control is operating, even if the vehicle is stopped.
- Always be aware of the selected speed and headway distance.
- Keep a safe distance according to road conditions and vehicle speed. If the headway distance is too close during high-speed driving, a serious collision may result.
- When maintaining distance with the vehicle ahead, if the front vehicle disappears, Smart Cruise Control may suddenly accelerate to the set speed. Always be aware of unexpected and sudden situations from occurring.
- Vehicle speed may decrease on an upward slope and increase on a downward slope.
- Always be aware of situations such as when a vehicle cuts in suddenly.
- When you are towing a trailer or another vehicle, turn off Smart Cruise Control for safety reasons.
- Turn off Smart Cruise Control when your vehicle is being towed.

- Smart Cruise Control may not operate properly if interfered by strong electromagnetic waves.
- Smart Cruise Control may not detect an obstacle in front and lead to a collision. Always look ahead cautiously to prevent unexpected and sudden situations from occurring.
- Vehicles moving in front of you with a frequent lane change may cause a delay in Smart Cruise Control reaction or may cause Smart Cruise Control to react to a vehicle actually in an adjacent lane. Always drive cautiously to prevent unexpected and sudden situations from occurring.
- Always be aware of the surroundings and drive safely, even though a warning message does not appear or an audible warning does not sound.
- If any other system's warning message appears or warning sound is generated, Smart Cruise Control warning message may not be displayed and warning sound may not be generated.
- You may not hear the warning sound of Forward Collision-Avoidance Assist if the surrounding is noisy.
- The vehicle manufacturer is not responsible for any traffic violation or accidents caused by the driver.
- Always set the vehicle speed under the speed limit in your area.

### **i** Information

- Smart Cruise Control may not operate for few seconds after the vehicle is started or the front view camera or front radar is initialized.
- You may hear a sound when the brake is controlled by Smart Cruise Control.

## Smart Cruise Control malfunction and limitations

### **Smart Cruise Control malfunction**



When Smart Cruise Control is not working properly, the **“Check Smart Cruise Control system.”** warning message and the master (🔔) warning light will appear on the instrument cluster. We recommend that your vehicle be inspected by a HYUNDAI authorised repairer.

### **Smart Cruise Control disabled**

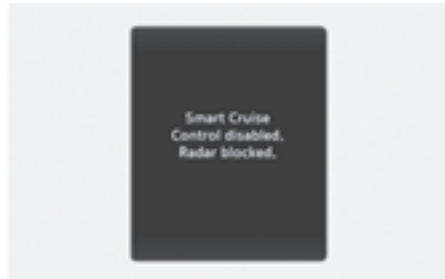

When the front radar cover or sensor is covered with snow, rain, or foreign material, it can reduce the detecting performance and temporarily limit or disable Smart Cruise Control.

If this occurs the **“Smart Cruise Control disabled. Radar blocked.”** warning message will appear for a certain period of time on the instrument cluster. But, it is not a malfunction.



Smart Cruise Control will operate properly when snow, rain or foreign material is removed.

### WARNING

Even though the warning message does not appear on the cluster, Smart Cruise Control may not properly operate.

### CAUTION

Smart Cruise Control may not properly operate in an area (for example, open terrain), where there is nothing to detect after turning ON the vehicle.

### ***Limitations of Smart Cruise Control***

Smart Cruise Control may not operate properly, or it may operate unexpectedly under the following circumstances:

- The detecting sensor or the surroundings are contaminated or damaged
- Washer fluid is continuously sprayed, or the wiper is on
- The camera lens is contaminated due to tinted, filmed or coated windscreen, damaged glass, or sticky foreign material (sticker, bug, etc.) on the glass
- Moisture is not removed or frozen on the windscreen
- The field of view of the front view camera is obstructed by sun glare
- Street light or light from an oncoming vehicle is reflected on the wet road surface, such as a puddle on the road
- The temperature around the front view camera is high or low
- An object is placed on the dashboard
- The surrounding is very bright
- The surrounding is very dark, such as in a tunnel, etc.
- The brightness changes suddenly, for example when entering or exiting a tunnel
- The brightness outside is low, and the headlights are not on or are not bright
- Driving in heavy rain or snow, or thick fog
- Driving through steam, smoke or shadow
- Only part of the vehicle is detected
- The vehicle in front has no tail lights, tail lights are located unusually, etc.
- The brightness outside is low, and the tail lights are not on or are not bright
- The rear of the front vehicle is small or does not look normal (for example, tilted, overturned, etc.)
- The front vehicle's ground clearance is low or high
- A vehicle suddenly cuts in front
- Your vehicle is being towed
- Driving through a tunnel or iron bridge
- Driving near areas containing metal substances, such as a construction zone, railroad, etc.
- An object reflecting off the front radar such as a guardrail, nearby vehicle, etc.
- The bumper around the front radar is impacted, damaged or the front radar is out of position
- The temperature around the front radar is high or low
- Driving in vast areas where there are few vehicles or structures (for example, desert, meadow, suburb, etc.)
- The vehicle in front is made of material that does not reflect on the front radar
- Driving near a highway (or motorway) interchange or tollgate
- Driving on a slippery surface due to snow, water puddle, ice, etc.
- Driving on a curved road
- The vehicle in front is detected late

- The vehicle in front is suddenly blocked by an obstacle
- The vehicle in front suddenly changes lane or suddenly reduces speed
- The vehicle in front is bent out of shape
- The front vehicle's speed is fast or slow
- With a vehicle in front, your vehicle changes lane at low speed
- The vehicle in front is covered with snow
- Unstable driving
- You are on a roundabout and the vehicle in front is not detected
- You are continuously driving in a circle
- Your vehicle moves unstably or vibrates excessively
- Your vehicle height is low or high due to heavy loads, abnormal tire pressure, etc.
- Driving in a parking lot
- Driving through a construction area, unpaved road, partial paved road, uneven road, speed bumps, etc.
- You are driving through roads with railroad tracks or other embedded metal objects
- Driving on an incline road, curved road, etc.
- Driving through a roadside with trees or streetlights
- The adverse road conditions cause excessive vehicle vibrations whilst driving
- Your vehicle height is low or high due to heavy loads, abnormal tyre pressure, etc.
- Driving through a narrow road where trees or grass are overgrown
- There is interference by electromagnetic waves, such as driving in an area with strong radio waves or electrical noise

### • Driving on a curved road



On curves, Smart Cruise Control may not detect a vehicle in the same lane, and may accelerate to the set speed. Also, vehicle speed may rapidly decrease when the vehicle ahead is detected suddenly.

Select the appropriate set speed on curves and apply the brake pedal or accelerator pedal according to the road and driving conditions ahead.



Your vehicle speed can be reduced due to a vehicle in the adjacent lane.

Apply the accelerator pedal and select the appropriate set speed. Check to be sure that the road conditions permit safe operation of the Smart Cruise Control.

- **Driving on an inclined road**



During uphill or downhill driving, the Smart Cruise Control may not detect a moving vehicle in your lane, and cause your vehicle to accelerate to the set speed. Also, vehicle speed will rapidly decrease when the vehicle ahead is detected suddenly.

Select the appropriate set speed on inclines and apply the brake pedal or accelerator pedal according to the road and driving conditions ahead.

- **Changing lanes**



[A] Your vehicle

[B] Lane changing vehicle

When a vehicle moves into your lane from an adjacent lane, it cannot be detected by the sensor until it is in the sensor's detection range. Smart Cruise Control may not immediately detect the vehicle when the vehicle changes lanes abruptly. In this case, you must maintain a safe braking distance, and if necessary, depress the brake pedal to reduce your driving speed in order to maintain a safe distance.

- **Situations when detecting are limited**

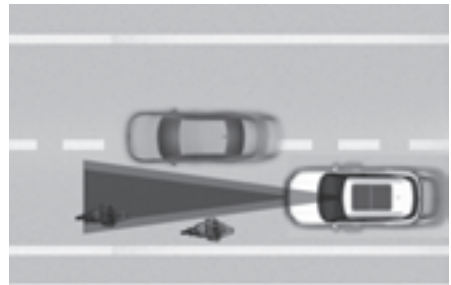

In the following cases, some vehicles, pedestrians or animals in your lane cannot be detected by the sensor:

- Vehicles offset to one side
- Slow-moving vehicles or sudden decelerating vehicles
- Vehicles with higher ground clearance or vehicles carrying loads that stick out of the back of the vehicle

- Vehicles that has the front lifted due to heavy loads
- Vehicles within about 2 m (6 ft.) from your vehicle
- Oncoming vehicles
- Stopped vehicles
- Vehicles with small rear profile, such as trailers
- Narrow vehicles, such as motorcycles or bicycles
- Special vehicles
- Animals and pedestrians
- Adjust your vehicle speed by depressing the brake pedal according to the road and driving conditions ahead.
- Adjust your vehicle speed by depressing the brake pedal according to the road and driving conditions ahead.

In the following cases, the vehicle in front cannot be detected by the sensor:

- You are steering your vehicle
- Driving on narrow or sharply curved roads

- When a vehicle ahead disappears at an intersection, your vehicle may accelerate.

Always pay attention to road and driving conditions whilst driving.

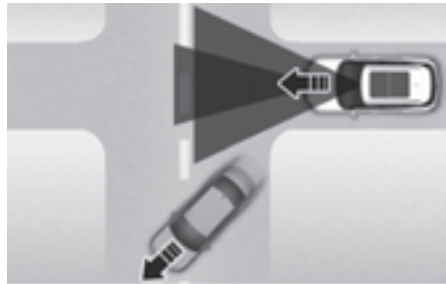

- When a vehicle in front of you merges out of the lane, Smart Cruise Control may not immediately detect the new vehicle that is now in front of you.

Always pay attention to road and driving conditions whilst driving.



- Always look out for pedestrians when your vehicle is maintaining a distance with the vehicle ahead.

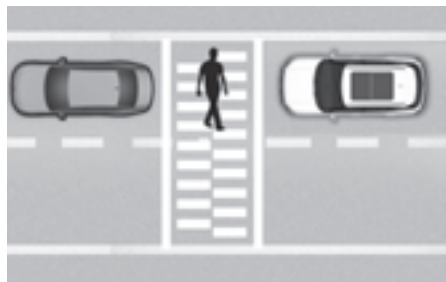

## Lane Following Assist (LFA)

 if equipped

Lane Following Assist detects lane markings and/or a vehicle ahead on the road, and centre your vehicle in the lane.

### Detecting sensor



[A] Front view camera

The front view camera is used as a detecting sensor to detect lane markings and front vehicles.

See the illustration above for the detailed location of the detecting sensor.

### CAUTION

For more information on the precautions of the front view camera, refer to the “Forward Collision-Avoidance Assist (FCA) (Sensor fusion)” section in this chapter.

## Lane Following Assist settings

### Warning methods



The Warning methods can be set with the vehicle on.

- **Warning volume:** Select **User settings > Driver assistance > Warning methods > Warning volume** from the settings menu in the instrument cluster or **Settings > Vehicle > Driver assistance > Warning methods > Warning volume** from the settings menu in the infotainment system to change the warning volume.
- **Driving safety priority:** Select **Settings > Vehicle > Driver assistance > Warning methods > Driving safety priority** from the settings menu in the infotainment system.

If **Driving safety priority** is selected, the vehicle lowers all other audio volumes when the warning sounds for safe driving.

## **i** Information

- If you change the **Warning methods**, the warning methods of other driver assistance systems may change.
- If the vehicle is restarted, **Warning Methods** will maintain the last setting.
- The setting menu may not exist based on vehicle specification.

## Lane Following Assist operation

### **Turning Lane Following Assist On/Off**



With the vehicle on, shortly press the Lane Driving Assist button located on the steering wheel to turn on Lane Following Assist. The grey or green (🚗) indicator light will appear on the cluster.

Press the button again to turn off the function.

### **Lane Following Assist**



If the vehicle ahead and/or both lane markings are detected and your vehicle speed is below 200 km/h (120 mph), the green (🚗) indicator light appears on the cluster, and Lane Following Assist helps centre the vehicle in the lane by assisting the steering wheel.

### **⚠ CAUTION**

When the steering wheel is not assisted, the white (🚗) indicator light blinks and changes to grey.

### **Hands-off warning**

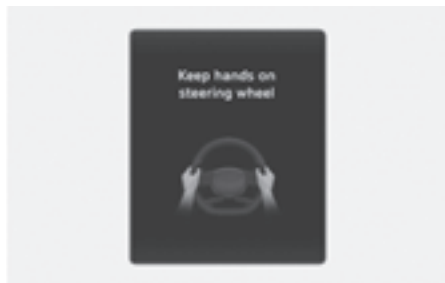

If the driver takes their hands off the steering wheel for several seconds, the **Keep hands on steering wheel** warning message will appear with a warning sound.

First stage: Warning message

Second stage: Warning message (red steering wheel) with a warning sound



If the driver still does not have their hands on the steering wheel after the hands-off warning, the **“Driving Convenience systems canceled”** warning message will appear and Lane Following Assist will be automatically cancelled.

### WARNING

- The steering wheel may not be assisted if the steering wheel is held very tight or the steering wheel is steered over a certain degree.
- Lane Following Assist does not operate at all times. It is the responsibility of the driver to safely steer the vehicle and to maintain the vehicle in its lane.
- The hands-off warning message may appear late depending on road conditions. Always have your hands on the steering wheel whilst driving.
- If the steering wheel is held very lightly the hands-off warning message may appear because Lane Following Assist may not recognise that the driver has their hands on the steering wheel.
- If you attach objects to the steering wheel, the hands-off warning may not work properly.

### Information

- For more information on instrument cluster settings, refer to the “4-29” section in chapter 4.
- When both lane markings are detected, the lane lines on the cluster will change from grey to white.

Lane undetected



Lane detected



- The images and colours in the cluster may differ depending on the cluster type or theme selected from the settings menu.
- If lane markings are not detected, steering wheel control by Lane Following Assist can be limited depending on whether a vehicle is in front or the driving conditions of the vehicle.
- Even though the steering is assisted by Lane Following Assist, the driver may control the steering wheel.
- The steering wheel may feel heavier or lighter when the steering wheel is assisted by Lane Following Assist than when it is not.

## Lane Following Assist malfunction and limitations

### *Lane Following Assist malfunction*



When Lane Following Assist is not working properly, the **Check Lane Following Assist system** warning message will appear on the instrument cluster for several seconds, and the master (△) warning light appears on the instrument cluster. If this occur, we recommend that your vehicle be inspected by a HYUNDAI authorised repairer.

### *Limitations of Lane Following Assist*

For more information on Lane Following Assist limitations, refer to the “Lane Keeping Assist (LKA)” section in this chapter.

#### *i* Information

For more information on Lane Following Assist precautions, refer to the “Lane Keeping Assist malfunction and limitations” section in this chapter.

## Rear View Monitor (RVM)

if equipped

Rear View Monitor shows the area behind the vehicle to assist you when parking or backing up.

#### *i* Information

If display audio is applied, the description of the Rear View Monitor may differ from the owner's manual. For more information, scan the QR code in the separately supplied simple manual.

### *Detecting sensor*



[A] Wide-rear view camera

Refer to the picture above for the detailed location of the detecting sensor.



## Rear View Monitor settings

### Warning methods



The Warning methods can be set with the vehicle on.

- **Parking safety priority:** Select **Settings > Vehicle > Driver assistance > Warning methods > parking safety priority** in the infotainment system. If **Parking safety priority** is enabled, the vehicle lowers all other audio volumes when a parking assist view is active.

### *i* Information

- If you change the **Warning methods**, the warning methods of other driver assistance systems may change.
- If the vehicle is restarted, **Warning methods** maintain the last setting.
- The setting menu may not exist based on vehicle specification.

### Camera settings

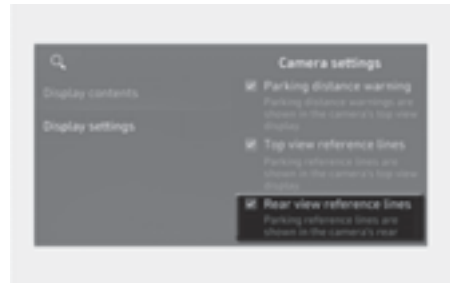

You can change Rear View Monitor **Display contents** by touching the setup icon (ⓘ) on the screen whilst Rear View Monitor is operating, or selecting **Driver assistance > Parking safety > Camera settings** from the **Settings** menu in the infotainment system whilst the engine is on.

In the **Display contents**, you can change settings for **Rear view reference lines**.

### Rear view reference lines

If **Rear view reference lines** is selected, the rear view parking guide lines and rear top view guide lines will be displayed at the left side of the infotainment system screen.

### *i* Information

- The horizontal guideline of the Rear View Parking Guidance shows the distance of 0.5 m (16 ft.), 1m (3.3 ft.) and 2.3 m (7.6 ft.) from the vehicle.
- The horizontal guideline of the Rear Top View Parking Guidance shows the tailgate opening distance and the distance of 1.5 m (4.9 ft.) from the vehicle.

## Rear View Monitor operation

### Parking/View button



Press the Parking/View button whilst the gear is in P (Park), D (Drive) or N (Neutral) to turn on the Rear View Monitor.

### Rear view

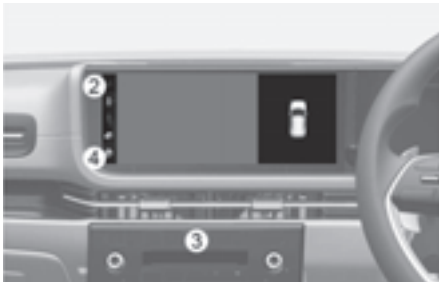

### Operating conditions

- The gear is shifted to R (Reverse).
- The Parking/View button (1) is pressed whilst the gear is in P (Park), N (Neutral) or D (Drive), and vehicle speed is 10 km/h (6 mph) or less.

Touch the Change View button (2) to select rear view or rear top view.

### Off conditions

- The gear is shifted to P (Park).
- The Parking/View button (1) or the Infotainment system screen button (3) is Pressed.
- The gear is in N (Neutral) or D (Drive) and the vehicle speed is above 10 km/h (6 mph).
- The previous button (4) is selected on the rear view menu.

### *i* Information

When the gear is in R (Reverse), the rear view does not turn off.

### Rear top view



Press the  icon.

The top view appears on the screen and the distance from the vehicle appears in the back of your vehicle.

### *i* Information

- The rear view cannot be turned off when the gear is in R (Reverse).
- When the Rear View Monitor is turned on, the last displayed view mode appears on the screen. If the gear is in R(Reverse), the rear view appears on the screen.

### **Extended rear camera use**

The rear view will maintain showing on the screen to help you when parking.

#### **Operating conditions**

The gear is shifted from R (Reverse) to N (Neutral) or D (Drive), and vehicle speed is 10 km/h (6 mph) or less.

#### **Off conditions**

- When vehicle speed is above 10 km/h (6 mph), the rear view will turn off.
- Shift the gear to P (Park), the rear view will turn off.
- Press the Parking/View button (1), the rear view will turn off.
- Press any button of the infotainment system button, the rear view will turn off.

### **Rear View whilst driving**

The driver is able to check the rear view on the screen whilst driving, it is to assist with backing up.

#### **Operating conditions**

- The Parking/View button (1) is pressed, whilst the gear is in P (Park), N (Neutral) or D (Drive), and the vehicle speed is above 10 km/h (6 mph)

#### **NOTICE**

If rear view is being displayed in the screen because of Extended rear view monitor function whilst the gear is in D (Drive) or N (Neutral) then press the Parking/View button twice, the driving rear view will appear on the screen.

#### **Off conditions**

- The gear is shifted to P (Park).
- The Parking/View button (1) is pressed again.
- One of the infotainment system screen button (3) is selected.
- The previous button (4) is selected on the rear view menu.

#### **When operating**

If the gear is shifted to R (Reverse), when rear view whilst driving appears on the screen, the screen will change to rear view.

#### **i Information**

- The rear view does not turn off regardless of the mode when the gear is in R (Reverse).
- When the rear view is activated, the latest used view mode is displayed.
- The rear parking guidelines are displayed in rear view and rear top view mode. (When selected in **Settings > Vehicle > Driver assistance > Parking safety > Camera settings > Display contents > Rear view reference lines** from the Settings menu in the infotainment system) However, rear parking guidelines are not displayed in the rear view whilst driving.
- The rear view whilst driving does not turn off even when the vehicle speed is lower than 10 km/h (6 mph) once it is on.
- When the rear view whilst driving is on, the rear top view will be deactivated.

## Rear View Monitor malfunction and limitations

### **Rear View Monitor malfunction**

When Rear View Monitor is not working properly, or the screen flickers, or the camera image does not display properly, we recommend that your vehicle be inspected by a HYUNDAI authorised repairer.

### **Limitations of Rear View Monitor**

When the vehicle is stopped for a long time in winter or when the vehicle is parked in an indoor parking lot, the exhaust fumes may temporarily blur the image.

#### **⚠ WARNING**

- The rear view camera does not cover the complete area behind the vehicle. The driver should always check the rear area directly through the inside and outside rearview mirror before parking or backing up.
- The image shown on the screen may differ from the actual distance of the object. Make sure to directly check the vehicle's surroundings for safety.
- Always keep the rear view camera lens clean. If the lens is covered with foreign material, it may adversely affect camera performance and Rear View Monitor may not operate properly. However, do not use chemical solvents such as strong detergents containing high alkaline or volatile organic solvents (petrol, acetone, etc.). This may damage the camera lens.

## Surround View Monitor (SVM)

**+** If equipped

Surround View Monitor uses the wide view cameras and displays images around your vehicle through the infotainment system screen to help with safe parking or driving.

### **Detecting sensor**



- [A] Wide-front view camera
- [B] Wide-side view camera (Below the outside rearview mirror)
- [C] Wide-rear view camera

Refer to the picture above for the detailed location of the detecting sensors.

## Surround View Monitor settings

### Warning methods

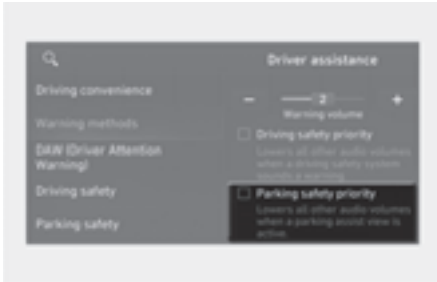

The Warning methods can be set with the vehicle on.

- **Parking safety priority:** Select **Settings > Vehicle > Driver assistance > Warning methods > parking safety priority** in the infotainment system. If **Parking safety priority** is enabled, the vehicle lowers all other audio volumes when a parking assist view is active.

### *i* Information

- If you change the **Warning methods**, the warning methods of other driver assistance systems may change.
- If the vehicle is restarted, **Warning methods** maintain the last setting.
- The setting menu may not exist based on vehicle specification.

### Camera settings

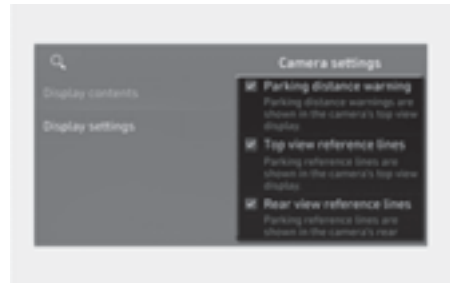

- You can change Surround View Monitor **Display contents** by touching the setup icon (⚙️) on the screen whilst Surround View Monitor is operating, or selecting **Driver assistance > Parking safety > Camera settings** from the **Settings** menu in the infotainment system whilst the engine is on.
- In the **Display contents**, you can change settings for **Parking distance warning**, **Top view reference lines** and **Rear view reference lines**.

### Parking distance warning

When the **Parking distance warning** is selected, parking distance warning appears on the right side of the Surround View Monitor screen.

### Top view reference lines

When the **Top view reference lines** is selected, parking guidance appears on the right side of the Surround View Monitor screen.

### *i* Information

The horizontal guideline of the Rear Top View Parking Guidance shows the tailgate opening distance of 2 m (6.6 ft.) from the vehicle.

### Rear view reference lines

When the **Rear view reference lines** is selected, parking guidance appears in the rear view.

#### **i** Information

The horizontal guideline shows the distance of 0.5 m (16 ft.), 1m (3.3 ft.) and 2.3 m (7.6 ft.).

### Surround view monitor auto on

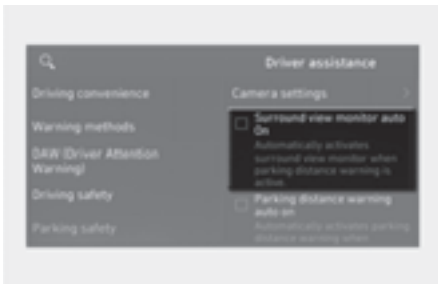

With the engine on, select **Driver assistance > Parking safety > Surround view monitor auto On** from the Settings menu in the infotainment system to use the function.

#### **i** Information

For more information on Surround view monitor auto On, refer to Surround View Monitor operation in this chapter.

## Surround View Monitor operation

### Parking/View button



Press the Parking/View button to turn on Surround View Monitor.

Press the button again to turn off the function.

### Front view



The front view appears on the screen when the gear is in N (Neutral) or D (Drive) to assist in parking.

You may select top view, front view, side view and 3D view using the change view button (2).

### Operating conditions

- The gear is shifted to N (Neutral) or D (Drive) from R (Reverse) and the vehicle speed is 10 km/h (6 mph) or less.
- The Parking/View button (1) is pressed, whilst the gear is in P (Park), N (Neutral) or D (Drive), and vehicle speed is 10 km/h (6 mph) or less.
- **Surround view monitor auto On** function is operated.

When **Driver assistance > Parking safety > Surround view monitor auto On** is selected from the Settings menu, the front view whilst parking appears.

### *i* Information

When the front view is activated, the latest used view mode is displayed.

---

### Off conditions

- The gear is shifted from N (Neutral) or D (Drive) to P (Park) or R (Reverse).
- The Parking/View button (1) or the Infotainment system button (3) is Pressed.
- Vehicle speed is above 10 km/h (6 mph).

### *i* Information

Surround View Monitor may turn off when vehicle speed is above 10 km/h (6 mph). However, Surround View Monitor may not turn on again although vehicle speed drops below 10 km/h (6 mph).

---

### Rear view

The rear view appears on the screen to assist in parking.

You may select top view, rear view, side view and 3D view using the change view button (2) .

### Operating conditions

- The gear is shifted to R (Reverse).
- The rear view is selected by pressing the change view button (2) after pressing the Parking/View button (1), whilst the gear is in P (Park), N (Neutral) or D (Drive), and vehicle speed is 10 km/h (6 mph) or less.

### Off conditions

- The gear is shifted to R (Reverse).
- The Parking/View button (1) is pressed, whilst the gear is in P (Park).

### *i* Information

When the gear is in R (Reverse), the rear view does not turn off even if the infotainment system button (3) is Pressed.

---

### **Front view whilst driving**

The driver is able to check the front view on the screen for safe driving.

You may select rear view whilst driving using the change view button (2) .

#### **Operating conditions**

- The Parking/View button (1) is pressed, whilst the gear is in N (Neutral) or D (Drive), and vehicle speed is above 10 km/h (6 mph).

#### **Off conditions**

- The Parking/View button (1) or the Infotainment system button (3) is pressed.
- The gear is shifted from N (Neutral) or D (Drive) to P (Park) or R (Reverse).
- The view mode button (2) is pressed when the vehicle speed is 10 km/h (6 mph) or less.

### ***i* Information**

- When the front view whilst driving is activated, the latest used view mode displayed.
  - The front view whilst driving does not turn off even when the vehicle speed is lower than 10 km/h (6 mph) once it is on.
  - When the front view whilst driving is on, the front top view and side view are deactivated in all speed.
- 

### **Rear View whilst driving**

The driver is able to check the rear view on the screen whilst driving, it is to assist with backing up.

#### **Operating conditions**

- The rear view is selected by pressing the change view button (2) after pressing the Parking/View button (1), whilst the gear is in N (Neutral) or D (Drive), and vehicle speed is above 10 km/h (6 mph).

You may select rear view or 3D view using the change view button (2) .

#### **Off conditions**

- The gear is shifted to P (Park).
- The Parking/View button (1) or the Infotainment system button (3) is Pressed.

### ***i* Information**

- When the rear view whilst driving is activated, the latest used view mode is displayed.
  - The Rear View Parking Lines does not operate on the rear view whilst driving.
  - The rear view whilst driving does not turn off even when the vehicle speed is lower than 10 km/h (6 mph) once it is on.
  - When the rear view whilst driving is on, the rear top view and rear side view are deactivated in all speed.
-



**3D view**

The 3D view shows the image around the vehicle from various angles.

You can change angles by tapping the screen. Press the 3D view button again to return to the initial angle.

**Operating conditions**

When the 3D view is selected by pressing the change view button (2):

- The gear is in P (Park), N (Neutral) or D (Drive) when vehicle speed is below 10 km/h (6 mph).
- The Surround View Monitor is turned on when the gear is in R (Reverse).

**Off conditions**

When the gear is in P (Park), N (Neutral) or D (Drive):

- The gear is shifted to P (Park) from N (Neutral) or D (Drive).
- The Parking/View button (1) or the Infotainment system button (3) is Pressed.
- Vehicle speed is above 10 km/h (6 mph).

When the gear is in R (Reverse):

- The gear is shifted to P (Park)

***i* Information**

3D view does not display guidelines.

---

**Surround View Monitor malfunction and limitations****Surround View Monitor malfunction**

When Surround View Monitor is not working properly, or the screen flickers, or the camera image does not display properly, we recommend that your vehicle be inspected by a HYUNDAI authorised repairer.

**Limitations of Surround View Monitor**

- When the vehicle is stopped for a long time in winter or when the vehicle is parked in an indoor parking lot, the exhaust fumes may temporarily blur the image.
- The screen may be displayed abnormally, and an icon may appear at the top left side of the screen under the following circumstances:
  - The tailgate is opened
  - The driver or front passenger door is opened
  - The outside rearview mirror is folded

**! WARNING**

- ALWAYS look around your vehicle to make sure there are no objects or obstacles before moving the vehicle. What you see on the screen may differ from the actual vehicle's location.
- The image shown on the screen may differ from the actual distance of the object. Make sure to directly check the vehicle's surroundings for safety.
- Surround View Monitor is designed to be used on a flat surface. Therefore, if used on roads with different heights such as kerbs and speed bumps, the image in the screen may not look correct.
- Always keep the camera lens clean. If the lens is covered with foreign material, it may adversely affect camera performance and Surround View Monitor may not operate properly. However, do not use chemical solvents such as strong detergents containing high alkaline or volatile organic solvents (petrol, acetone, etc.). This may damage the camera lens.

**i Information**

Surround View Monitor uses the cameras installed on the vehicle to show images around the vehicle through the infotainment system screen. The image shown on the screen may look unnatural depending on the surroundings.

## Rear Cross-Traffic Collision-Avoidance Assist (RCCA)

**+ if equipped**

Rear Cross-Traffic Collision-Avoidance Assist detects vehicles approaching from the rear left or right whilst your vehicle is reversing and warns you of a possible collision with a warning message and a warning sound. Also, Rear Cross-Traffic Collision-Avoidance Assist may assist with braking your vehicle to help avoid a collision.

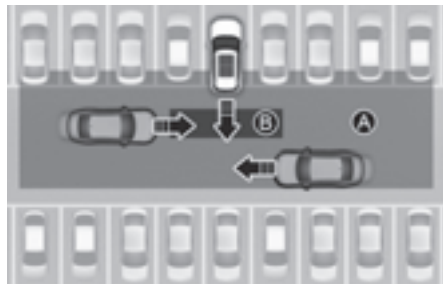

- [A] Rear Cross-Traffic Collision Warning operating range
- [B] Rear Cross-Traffic Collision-Avoidance Assist operating range

**! CAUTION**

Warning timing may vary depending on the speed of the approaching vehicle.

## Detecting sensor



[A] Rear corner radar

Refer to the picture above for the detailed location of the detecting sensors.

### *i* Information

For more information on the precautions of the rear corner radars, refer to the “Blind-Spot Collision-Avoidance Assist (BCA)” section in this chapter.

## Rear Cross-Traffic Collision-Avoidance Assist settings

### Rear cross-traffic safety

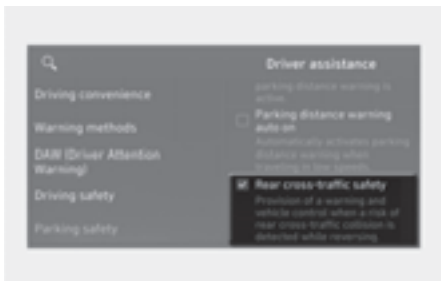

With the vehicle on, select **User settings > Driver assistance > Parking safety > Rear cross-traffic safety** from the settings menu in the instrument cluster or **Settings > Driver assistance > Parking safety > Rear cross-traffic safety** from the settings menu in the infotainment system to turn on Rear Cross-Traffic

Collision-Avoidance Assist and deselect to turn off the function.

### *!* WARNING

When the engine is restarted, Rear Cross-Traffic Collision-Avoidance Assist always turn on. However, if **Off** is selected after the engine is restarted, the driver should always be aware of the surroundings and drive safely.

### Warning methods



The Warning methods can be set with the engine on.

- **Warning volume:** Select **User settings > Driver assistance > Warning methods > Warning volume** from the settings menu in the instrument cluster or **Settings > Vehicle > Driver assistance > Warning methods > Warning volume** from the Settings menu in the infotainment system to change the warning volume.

### *i* Information

- If you change the **Warning methods**, the warning methods of other driver assistance systems may change.
- If the engine is restarted, **Warning methods** maintain the last setting.
- The setting menu may not exist based on vehicle specification.

## Rear Cross-Traffic Collision-Avoidance Assist operation

Rear Cross-Traffic Collision-Avoidance Assist warns and helps control the vehicle depending on collision risk level: 'Collision Warning', 'Emergency Braking' and 'Stopping vehicle and ending brake control'.

### Collision Warning



- Rear Cross-Traffic Collision-Avoidance Assist operates when all the following conditions are satisfied:
- The gear is shifted to R (Reverse)
- Vehicle speed is below 8 km/h (5 mph)
- The approaching vehicle is within about 25 m (82 ft.) from the left and right side of your vehicle
- The speed of the vehicle approaching from the left and right is above 5 km/h (3 mph)

### *i* Information

- If the operating conditions are satisfied, there may be a warning whenever the vehicle approaches from the left or right side even though your vehicle speed is 0 km/h (0 mph).
- The images and colours in the cluster may differ depending on the cluster type or theme selected from the cluster.

### Emergency Braking



- To warn the driver of an approaching vehicle from the rear left/right side of your vehicle, the warning light on the outside rearview mirror blinks and a warning message appears on the instrument cluster. At the same time, an audible warning sounds. A warning also appears on the infotainment system.

- Rear Cross-Traffic Collision-Avoidance Assist operates when all the following conditions are satisfied:
  - The gear is shifted to R (Reverse)
  - Vehicle speed is below 8 km/h (5 mph)
  - The approaching vehicle is within about 1.5 m (5 ft.) from the left and right side of your vehicle
  - The speed of the vehicle approaching from the left and right is above 5 km/h (3 mph)
  - Emergency braking is assisted to help prevent collision with approaching vehicles from the left and right.

### WARNING

Brake control will end when:

- The approaching vehicle is out of the detecting range
- The approaching vehicle passes behind your vehicle
- The approaching vehicle does not drive toward your vehicle
- The approaching vehicle speed slows down
- The driver depresses the brake pedal with sufficient power

### **Stopping vehicle and ending brake control**

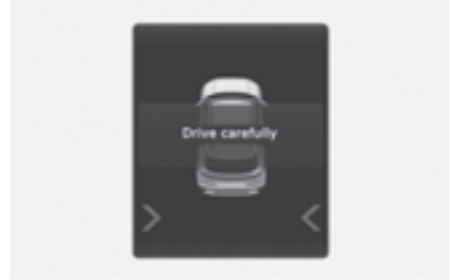

- When the vehicle is stopped due to emergency braking, the “**Drive carefully**” warning message will appear on the cluster.
- For your safety, the driver should depress the brake pedal immediately and check the surroundings.
- Brake control will end after the vehicle is stopped by emergency braking for about 2 seconds.
- During emergency braking, braking control by Rear Cross-Traffic Collision-Avoidance Assist will automatically cancel when the driver excessively depresses the brake pedal.

### **WARNING**

Take the following precautions when using Rear Cross-Traffic Collision-Avoidance Assist:

- For your safety, only change the Settings after parking the vehicle at a safe location.
- If any other system's warning message appears or audible warning is generated, Rear Cross-Traffic Collision-Avoidance Assist warning message may not be displayed and audible warning may not be generated.
- You may not hear the warning sound of Rear Cross-Traffic Collision-Avoidance Assist if the surrounding is noisy.
- Rear Cross-Traffic Collision-Avoidance Assist may not operate if the driver applies the brake pedal to avoid collision.
- During Rear Cross-Traffic Collision-Avoidance Assist operation, the vehicle may stop suddenly injuring passengers and shifting loose objects. Always have the seat belt on and keep loose objects secured.
- Even if there is a problem with Rear Cross-Traffic Collision-Avoidance Assist, the vehicle's basic braking performance will operate properly.
- When Rear Cross-Traffic Collision-Avoidance Assist is operating, braking control by the function will automatically cancel when the driver excessively depresses the accelerator pedal.

- Rear Cross-Traffic Collision-Avoidance Assist does not operate in all situations or cannot avoid all collisions.
  - Rear Cross-Traffic Collision-Avoidance Assist may warn the driver late or may not warn the driver depending on the road and driving conditions.
  - The driver has the responsibility to control the vehicle. Do not solely depend on Rear Cross-Traffic Collision-Avoidance Assist. Rather, maintain a safe braking distance, and if necessary, depress the brake pedal to reduce driving speed or to stop the vehicle.
  - Never deliberately operate Rear Cross-Traffic Collision-Avoidance Assist on people, animal, objects, etc. It may cause serious injury or death.
- 

### **CAUTION**

The brake control may not operate properly depending on the status of ESC (Electronic Stability Control).

There will only be a warning when:

- The ESC (Electronic Stability Control) warning light is on
  - ESC (Electronic Stability Control) is engaged in a different function
- 

### **Information**

If braking is assisted by Rear Cross-Traffic Collision-Avoidance Assist, the driver must immediately depress the brake pedal and check vehicle surroundings.

- Brake control will end when the driver depresses the brake pedal with sufficient power.
  - After shifting the gear to R (Reverse), braking control will operate once for left and right vehicle approach.
-

## Rear cross-traffic collision-avoidance assist malfunction and limitations

### **Rear Cross-Traffic Collision-Avoidance Assist malfunction**

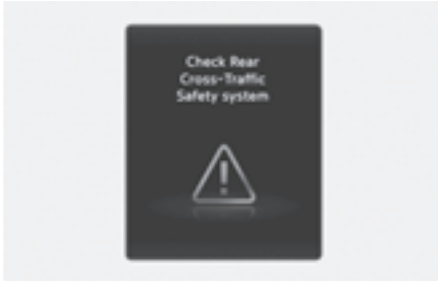

When Rear Cross-Traffic Collision-Avoidance Assist is not working properly, the **“Check Rear Cross-Traffic Safety system”** warning message will appear on the instrument cluster for several seconds, and the master (🚨) warning light will illuminate on the instrument cluster. If this occur, we recommend that your vehicle be inspected by a HYUNDAI authorised repairer.



When the outside rearview mirror warning light is not working properly, the **“Check side view mirror warning light”** warning message appears on the instrument cluster for several seconds, and the master (🚨) warning light illuminates on the cluster. If this occur, we recommend that your vehicle be inspected by a HYUNDAI authorised repairer.

### **Rear Cross-Traffic Collision-Avoidance Assist disabled**

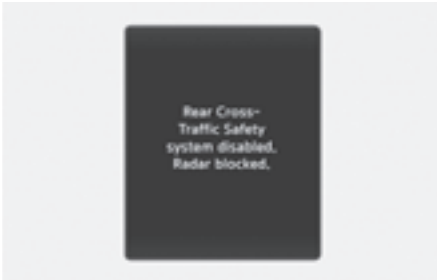

When the rear bumper around the rear-side radar or sensor is covered with foreign material, such as snow or rain, or installing a trailer or carrier, it can reduce the detecting performance and temporarily limit or disable Rear Cross-Traffic Collision-Avoidance Assist.

If this occurs, the **“Rear Cross-Traffic Safety system disabled. Radar blocked.”** warning message appears on the instrument cluster.

Rear Cross-Traffic Collision-Avoidance Assist operates properly when such foreign material or trailer, etc., is removed.

If Rear Cross-Traffic Collision-Avoidance Assist does not operate properly after it is removed, we recommend that your vehicle be inspected by a HYUNDAI authorised repairer.

### **⚠ WARNING**

- Even though the warning message does not appear on the cluster, Rear Cross-Traffic Collision-Avoidance Assist may not operate properly.
- Rear Cross-Traffic Collision-Avoidance Assist may not operate properly in an area (for example, open terrain), where any objects are not detected after turning ON the engine.

### **⚠ CAUTION**

Turn off Rear Cross-Traffic Collision-Avoidance Assist to install or remove a trailer, carrier, or another attachment. Turn on Rear Cross-Traffic Collision-Avoidance Assist when finished.

### **Limitations of Rear Cross-Traffic Collision-Avoidance Assist**

Rear Cross-Traffic Collision-Avoidance Assist may not operate properly, or it may operate unexpectedly under the following circumstances:

- Departing from where trees or grass are overgrown
- Departing from where roads are wet
- Speed of the approaching vehicle is fast or slow



Braking control may not work, driver's attention is required in the following circumstances:

- The vehicle severely vibrates whilst driving over a bumpy road, uneven road or concrete patch
- Driving on a slippery surface due to snow, water puddle, ice, etc.
- The tyre pressure is low or a tyre is damaged
- The braking system has been modified
- Remote Smart Parking Assist is operating (if equipped)

### **i** Information

For more information on the limitations of the rear corner radar, refer to the "Detecting sensor" section in this chapter.

### **⚠** WARNING

- **Driving near a vehicle or structure**

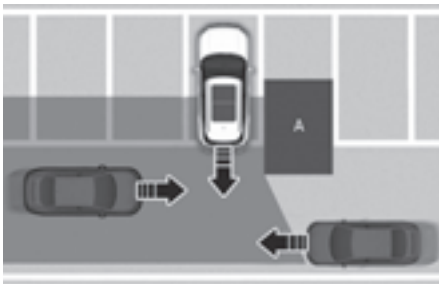

[A] Structure

Rear Cross-Traffic Collision-Avoidance Assist may be limited when driving near a vehicle or structure, and may not detect the vehicle approaching from the left or right. If this occurs, the function may not warn the driver or control the brakes when necessary.

Always check your surroundings whilst backing up.

- **When the vehicle is in a complex parking environment**

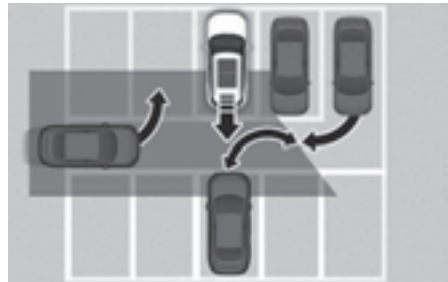

Rear Cross-Traffic Collision-Avoidance Assist may detect vehicles which are parking or pulling out near your vehicle (for example, a vehicle leaving beside your vehicle, a vehicle parking or pulling out in the rear area, a vehicle approaching your vehicle making a turn, etc.). If this occurs, the function may unnecessarily warn the driver and control the brake.

Always check your surroundings whilst backing up.

- **When the vehicle is parked diagonally**

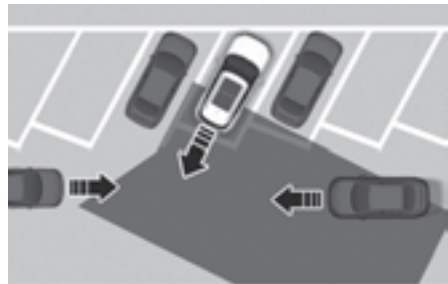

Rear Cross-Traffic Collision-Avoidance Assist may be limited when backing up diagonally, and may not detect the vehicle approaching from the left or right. If this occurs, the function may not warn the driver or control the brakes when necessary.

Always check your surroundings whilst backing up.

- When the vehicle is on or near a slope

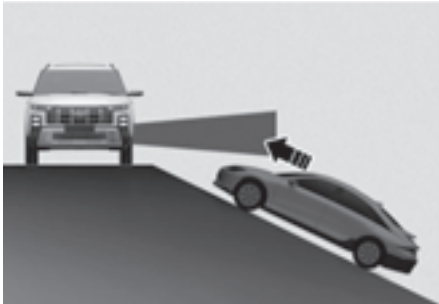

Rear Cross-Traffic Collision-Avoidance Assist may be limited when the vehicle is on an uphill or downhill slope, or near it, and may not detect the vehicle approaching from the left or right. If this occurs, the function may not warn the driver or control the brakes when necessary.

Always check your surroundings whilst backing up.

- Pulling into the parking space where there is a structure

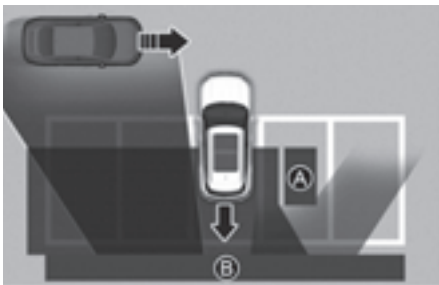

[A] Structure  
[B] Wall

Rear Cross-Traffic Collision-Avoidance Assist may detect vehicles passing by in front of you when parking in reverse into a parking space with a wall or structure in the rear or side area. If this occurs, the function may unnecessarily warn the driver and control the brake.

Always check your surroundings whilst backing up.

- When the vehicle is parked rearward

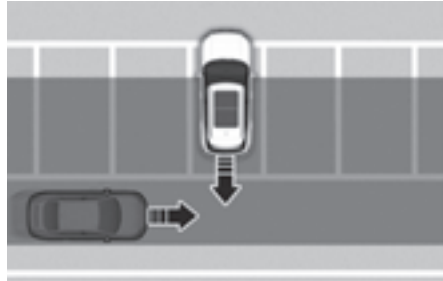

Rear Cross-Traffic Collision-Avoidance Assist may detect vehicles passing by behind you when parking in reverse into a parking space. If this occurs, the function may unnecessarily warn the driver and control the brake.

Always check your surroundings whilst backing up.

### WARNING

- When you are towing a trailer or turn off Rear Cross-Traffic Collision-Avoidance Assist for safety reasons.
- Rear Cross-Traffic Collision-Avoidance Assist may not operate properly if interfered by strong electromagnetic waves.
- Rear Cross-Traffic Collision-Avoidance Assist may not operate for 3 seconds after the vehicle is started, or the rear corner radars are initialized.

## Reverse Parking Distance Warning (PDW)

 if equipped

Reverse Parking Distance Warning can help warn the driver if an obstacle is detected within a certain distance when the vehicle is moving in reverse at low speeds.

### Detecting sensor



[A] : Sensor

Refer to the image above for the detailed location of the detecting sensors.

## Reverse Parking Distance Warning settings

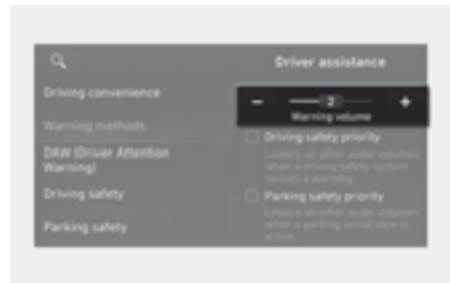

### Warning methods

With the engine on, select **User Settings > Driver assistance > Warning methods > Warning volume** from the Settings menu in the cluster or **Settings > Vehicle > Driver assistance > Warning methods > Warning Volume** from the settings menu in the infotainment system to change the warning volume.

### Information

- If you change the **Warning methods**, the warning methods of other driver assistance systems may change.
- If the engine is restarted, **Warning methods** maintains the last setting.
- The setting menu may not exist based on vehicle specification.

## Reverse Parking Distance Warning operation

### Parking safety button

 If equipped





- Press the Parking Distance Warning Off (P) button to turn off Reverse Parking Distance Warning. Press the button again to turn on the function.
- When Reverse Parking Distance Warning is off (button indicator light off), if you shift the gear to R (Reverse), the function will automatically turn on.

### Reverse parking distance warning

Reverse Parking Distance Warning will operate when the gear is in R (Reverse).

Reverse Parking Distance Warning helps detect a person, animal or object at the rear when the vehicle's rearward speed is below 10 km/h (6 mph).

Distance from object	Warning indicator Driving rearward	Warning sound
60~120 cm (24~40 in.)		Buzzer beeps intermittently
30~60 cm (12~24 in.)		Beeps more frequently
within 30 cm (12 in.)		Beeps continuously

- The corresponding indicator will illuminate whenever each ultrasonic sensor detects a person, animal or object in its sensing range. Also an audible warning will sound.
- When more than two objects are detected at the same time, the closest one will be warned with an audible warning.
- The shape of the indicator in the illustration may differ from the actual vehicle.

## Reverse Parking Distance Warning malfunction and limitations

### **Parking Distance Warning malfunction**

After starting the vehicle, a beep may sound when the gear is shifted to R (Reverse) to indicate Parking Distance Warning is operating properly.

However, if one or more of the following occurs, first check whether the ultrasonic sensor is damaged or blocked with foreign material. If it still does not work properly we recommend that your vehicle be inspected by a HYUNDAI authorised repairer.

- The audible warning does not sound.
- The buzzer sounds intermittently.
- The “**Check Parking Distance Warning system**” warning message appears on the cluster.



### **Parking Distance Warning disabled**

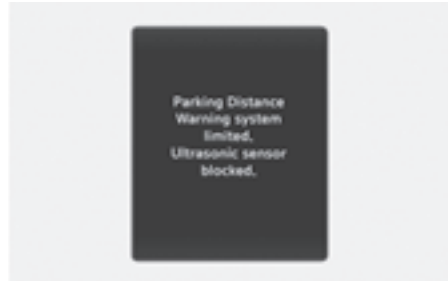

If this occurs the “**Parking Distance Warning system limited. Ultrasonic sensor blocked.**” warning message appears on the instrument cluster. Parking Distance Warning operates properly when snow, rain or foreign material is removed.

If Parking Distance Warning does not operate properly after obstruction (snow, rain, or foreign material) is removed (including trailer, carrier, etc., from the rear bumper), we recommend that your vehicle be inspected by a HYUNDAI authorised repairer.

### **i Information**

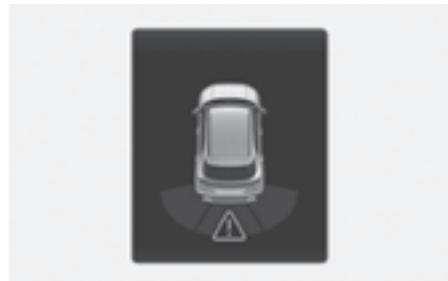

When the Parking Distance Warning is operating, if the function is not working normally or the ultrasonic sensor is blocked, the master warning light (△) appears in the direction of the corresponding sensor. You can check the warning in the Utility view on the cluster.

### **Limitations of reverse parking distance warning**

- Reverse Parking Distance Warning may not operate properly when:
  - Moisture is frozen to the sensor
  - Sensor is covered with substances, such as snow or water (Reverse Parking Distance Warning will operate properly when such foreign substances are removed.)
  - The weather is extremely hot or cold
  - The sensor or sensor assembly is disassembled
  - The surface of the sensor is pressed hard or hit with a hard object
  - The surface of the sensor is scratched by a sharp object
  - The sensor or its surrounding area are sprayed directly with high pressure washer
- Reverse Parking Distance Warning may malfunction when:
  - Heavy rain or water spray is present
  - Water flows on the surface of the sensor
  - Affected by another vehicle's sensors
  - The sensor is covered with snow or ice
  - Driving on uneven road, gravel roads or bushes
  - Objects that generate ultrasonic waves are near the sensor
  - The licence plate is installed in a different spot from the original location
  - The vehicle bumper height or ultrasonic sensor installation has been modified
  - Attaching equipment or accessories next to the ultrasonic sensors
- The following objects may not be detected:
  - Sharp or slim objects, such as ropes, chains or small poles.
  - Objects, which tend to absorb sensor frequency, such as clothes, spongy material or snow.
  - Objects smaller than 100 cm (40 in.) in length and narrower than 14 cm (6 in.) in diameter.
  - Pedestrians, animals or objects that are very close to the ultrasonic sensors
- Parking Distance Warning Indicators may be displayed differently from the actual detected location when the obstacle is located between the sensors.
- Parking Distance Warning indicators may not occur sequentially depending on vehicle speed or obstacle shape.
- If Reverse Parking Distance Warning system needs repair, we recommend that the vehicle be inspected and repaired by a HYUNDAI authorised repairer.

## Forward/Reverse Parking Distance Warning (PDW)

Forward/Reverse Parking Distance Warning uses the front and rear ultrasonic sensors to detect and warns you if a person, animal, or object is within a certain distance when your vehicle is stopped or driving at low speed.

### Detecting sensor



[A] Front ultrasonic sensors  
[B] Rear ultrasonic sensors

Refer to the picture above for the detailed location of the detecting sensors.

## Forward/Reverse Parking Distance Warning settings

### Warning Methods

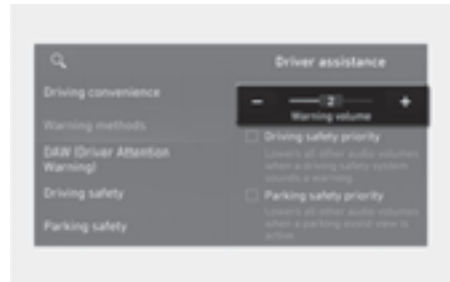

The Warning Methods can be set with the engine on.

- **Warning volume:** Select **User settings > Driver assistance > Warning methods > Warning volume** from the settings menu in the instrument cluster or **Settings > Vehicle > Driver assistance > Warning methods > Warning volume** from the settings menu in the infotainment system with the engine on, to change the warning volume.

### *i* Information

- If you change the **Warning methods**, the warning methods of other driver assistance systems may change.
- If the engine is restarted, **Warning methods** maintains the last setting.
- The setting menu may not exist based on vehicle specification.

## Forward/Reverse Parking Distance Warning operation

### Parking Safety button



Press the Parking Safety (P<sup>SA</sup>) button to turn on Forward/Reverse Parking Distance Warning. Press the button again to turn off the function.

- When the gear is shift to R (Reverse), Parking Distance Warning automatically turns on (Parking Safety button indicator on).

### Forward Parking Distance Warning

Forward Parking Distance Warning operates when one of the condition is satisfied.

- The gear is shifted from R (Reverse) to D (Drive) with Reverse Parking Distance Warning on.
- The gear is in D (Drive) and the Parking Safety button indicator light is on.

### *i* Information

- Forward Parking Distance Warning operates only when the vehicle's forward speed is below 10 km/h (6 mph).
- Forward Parking Distance Warning is deactivated if the vehicle speed reaches above 30 km/h (20 mph). It may not reactivate although the vehicle speed drops below 10 km/h (6 mph).

Distance from object	Warning indicator when driving forward	Warning sound
60-120 cm (24-48 inches)		Buzzer beeps intermittently
30-60 cm (12-24 inches)		Beeps more frequently
within 30 cm (12 inches)		Beeps continuously

- The corresponding indicator illuminates whenever each ultrasonic sensor detects a person or object in its sensing range. Also an audible warning sounds.
- When more than two objects are detected at the same time, the closest one is warned with an audible warning.
- The shape of the indicator in the illustration may differ from the actual vehicle.





### Reverse Parking Distance Warning

Reverse Parking Distance Warning operates under the following conditions.

- The gear is shifted to R (Reverse).

#### *i* Information

Reverse Parking Distance Warning operates when the vehicle's reverse speed is below 10 km/h (6 mph).

Distance from object	Warning indicator when driving forward	Warning sound
60-120 cm (24-48 inches)		Buzzer beeps intermittently
30-60 cm (12-24 inches)		Buzzer beeps intermittently
within 30 cm (12 inches)		Beeps continuously

- The corresponding indicator illuminates whenever each ultrasonic sensor detects a person or object in its sensing range. Also an audible warning sounds.
- When more than two objects are detected at the same time, the closest one is warned with an audible warning.
- The shape of the indicator in the illustration may differ from the actual vehicle.

### Forward/Reverse Parking Distance Warning malfunction and limitations

#### **Parking Distance Warning malfunction**

After starting the vehicle, a beep may sound when the gear is shifted to R (Reverse) to indicate Parking Distance Warning is operating properly.

However, if one or more of the following occurs, first check whether the ultrasonic sensor is damaged or blocked with foreign material. If it still does not work properly we recommend that your vehicle be inspected by a HYUNDAI authorised repairer.

- The audible warning does not sound.
- The buzzer sounds intermittently.
- The **“Check Parking Distance Warning system”** warning message appears on the cluster.



### Parking Distance Warning disabled



If this occurs the **“Parking Distance Warning system limited. Ultrasonic sensor blocked.”** warning message appears on the instrument cluster. Parking Distance Warning operates properly when snow, rain or foreign material is removed.

If Parking Distance Warning does not operate properly after obstruction (snow, rain, or foreign material) is removed (including trailer, carrier, etc., from the rear bumper), we recommend that your vehicle be inspected by a HYUNDAI authorised repairer.

#### **i** Information

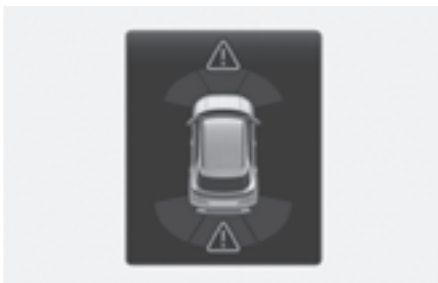

When the Parking Distance Warning is operating, if the function is not working normally or the ultrasonic sensor is blocked, the master warning light (▲) appears in the direction of the corresponding sensor. You can check the warning in the Utility view on the cluster.

### Limitations of Forward/Reverse Parking Distance Warning

- Parking Distance Warning may not operate properly when:
  - Moisture is frozen to the sensor
  - Sensor is covered with substance, such as snow or water (Forward/Reverse Parking Distance Warning operates properly when such substance is removed.)
  - The weather is extremely hot or cold
  - The sensor or sensor assembly is disassembled
  - The surface of the sensor is pressed hard or hit with a hard object
  - The surface of the sensor is scratched with a sharp object
  - The sensors or its surrounding area is directly sprayed with high pressure washer
- Parking Distance Warning may malfunction when:
  - Heavy rain or water spray is present
  - Water flows on the surface of the sensor
  - Affected by another vehicle’s sensors
  - The sensor is covered with snow or ice
  - Driving on uneven road, gravel roads or bushes
  - Objects that generates ultrasonic waves are near the sensor
  - License plate is installed in a different spot from the original location
  - The vehicle bumper height or ultrasonic sensor installation has been modified
  - Attaching equipment or accessories next to the ultrasonic sensors

- The following objects may not be detected:
  - Sharp or slim objects, such as ropes, chains or small poles.
  - Narrow objects, such as corners of a square column
  - Objects, which tend to absorb sensor frequency, such as clothes, spongy material or snow.
  - Objects smaller than 40 inches (100 cm) in length and narrower than 6 inches (14 cm) in diameter.
  - Pedestrians, animals or objects that are very close to the ultrasonic sensors

### WARNING

- Parking Distance Warning is a supplemental function. The operation of Parking Distance Warning can be affected by several factors (including environmental conditions). It is the responsibility of the driver to always check the front and rear views before and whilst parking.
  - Your new vehicle warranty does not cover any accidents or damage to the vehicle due to the malfunction of Parking Distance Warning.
  - Pay close attention when driving near objects, pedestrians, and especially children. Some objects may not be detected by the ultrasonic sensors, due to the objects distance, size or material, all of which can limit the effectiveness of the sensor.
  - Parking Distance Warning does not warn you in the order of detection. It varies depending on the speed of the vehicle or the shape of a person, animal, or object.
  - If the Parking Distance Warning does not operate properly, we recommend that your vehicle be inspected by a HYUNDAI authorised repairer.
-



# 8. Emergency Situations

Hazard warning flasher .....	8-2
In case of an emergency whilst driving .....	8-2
If the engine stalls whilst driving .....	8-2
If the engine stalls at a crossroad or crossing.....	8-2
If you have a flat tyre whilst driving.....	8-3
If the engine does not start.....	8-3
Jump starting.....	8-4
If the engine overheats .....	8-7
Tyre pressure monitoring system (TPMS).....	8-8
Check tyre pressure.....	8-9
Tyre pressure monitoring system .....	8-9
Low tyre pressure warning light .....	8-10
Low tyre pressure position and tyre pressure telltale .....	8-10
TPMS malfunction indicator.....	8-11
Changing a tire with TPMS .....	8-12
If you have a flat tyre (With spare tyre).....	8-13
Jack and tools .....	8-13
Changing tyres .....	8-14
Jack label.....	8-18
EC declaration of conformity for jack.....	8-19
Towing.....	8-20
Towing service .....	8-20
Removable towing hook.....	8-21
Emergency towing.....	8-22
Emergency commodity.....	8-24
First aid kit .....	8-24
Triangle reflector.....	8-24

## Hazard warning flasher



The hazard warning flasher warns other drivers to exercise extreme caution when approaching, overtaking, or passing your vehicle.

It should be used whenever making emergency repairs or when stopped near the edge of a roadway.

To turn on or off the hazard warning flasher, press the hazard warning flasher button with the Engine Start/Stop button in any position. The hazard warning flasher button is located in the centre fascia panel. All turn signal lights flash simultaneously.

- The hazard warning flasher operates regardless of whether your vehicle is running or not.
- The turn signals do not work when the hazard flasher is on.

## In case of an emergency whilst driving

### If the engine stalls whilst driving

- Reduce the vehicle speed gradually, keeping a straight line. Move cautiously off the road to a safe place.
- Turn on your hazard warning flasher.
- Try to start the engine again. If your vehicle does not start, we recommend you to contact a HYUNDAI authorised repairer.

### If the engine stalls at a crossroad or crossing

If the engine stalls at a crossroads or crossing, if safe to do so, shift the gear to N (Neutral) and then push the vehicle to a safe location.

If your vehicle has a manual transmission not equipped with a ignition lock switch, the vehicle can move forward by shifting to the 2(second) or 3(third) gear and then turning the starter without depressing the clutch pedal.

## If you have a flat tyre whilst driving

If a tyre goes flat whilst you are driving:

- Take your foot off the accelerator pedal and let the vehicle slow down whilst driving straight ahead. Do not apply the brakes immediately or attempt to pull off the road because this may cause loss of vehicle control resulting in a collision. When the vehicle has slowed to such a speed that it is safe to do so, brake carefully and pull off the road. Drive off the road as far as possible and park on a firm, level ground. If you are on a divided highway, do not park in the median area between the two traffic lanes.
- When the vehicle is stopped, press the hazard warning flasher button, shift the gear to P (Park), apply the parking brake, and place the ignition switch or Engine Start/Stop button to the OFF position.
- Have all passengers get out of the vehicle. Make sure they all get out on the side of the vehicle that is away from traffic.
- When changing a flat tyre, follow the instructions provided later in this chapter.

## If the engine does not start

- Be sure the shift gear is in N (Neutral) or P (Park) if it is automatic transmission/intelligent variable transmission/dual clutch transmission vehicle. The engine starts only when the shift gear is in N (Neutral) or P (Park).
- Turn on the interior light. If the light dims or goes out when you operate the starter, the battery is drained. Refer to the instructions in the “Jump starting” section in this chapter.
- Check the fuel level and add fuel if necessary.

If the vehicle still does not start, we recommend that you contact for assistance.

### **NOTICE**

Starting the vehicle by pushing or pulling may cause the catalytic converter to overload and damage the emission control system.

## Jump starting

Jump starting can be dangerous if done incorrectly. Follow the jump starting procedure in this section to avoid serious injury or damage to your vehicle. If in doubt about how to properly jump start your vehicle, have a service technician or towing service do it for you.

### **WARNING**

To prevent serious injury or death to you or bystanders, always follow these precautions when working near or handling the battery:



Always read and follow instructions carefully when handling a battery.



Wear eye protection designed to protect the eyes from acid splashes.



Keep all flames, sparks, or smoking materials away from the battery.



Hydrogen gas is always present in battery cells, is highly combustible, and may explode if ignited.



Keep batteries out of reach of children.



Batteries contain sulfuric acid that is highly corrosive. Do not allow acid to contact your eyes, skin, or clothing.

If acid gets into your eyes, flush your eyes with clean water for at least 15 minutes and get immediate medical attention. If acid gets on your skin, thoroughly wash the area. If you feel pain or a burning sensation, get medical attention immediately.



- When lifting a plastic-cased battery, excessive pressure on the case may cause battery acid to leak. Lift with a battery carrier or with your hands on opposite corners.
- Do not attempt to jump start your vehicle if your battery is frozen.
- Never attempt to recharge the battery when the vehicle's battery cables are connected to the battery.
- The electrical ignition system works with high voltage.  
Never touch these components with the engine running or when the Engine Start/Stop button is in the ON position.
- Do not allow the positive (+) and negative (-) jumper cables to touch. It may cause sparks.

### ***Jump starting procedure***

1. Position the vehicles close enough that the jumper cables can reach. Do not allow the vehicles to touch.
2. Avoid fans or any moving parts in the engine compartment at all times, even when the vehicles are turned off.
3. Turn off all electrical devices such as radios, lights, air conditioning, etc. Put the vehicles in P (Park) and apply the parking brake. Turn both vehicles OFF.
4. Open the engine bonnet.
5. Remove the engine compartment fuse box cover.
6. Connect the jumper cables in the exact sequence shown in the illustration. First connect one jumper cable to the red, positive (+) battery terminal of your vehicle (1).
7. Connect the other end of the jumper cable to the red, positive (+) battery/jumper terminal of the assisting vehicle (2).
8. Connect the second jumper cable to the black, negative (-) battery/jumper terminal of the assisting vehicle (3).

### **⚠ CAUTION**

Before jump starting, make sure to correctly identify the positive (+) and negative (-) terminals to avoid reverse polarity connections.

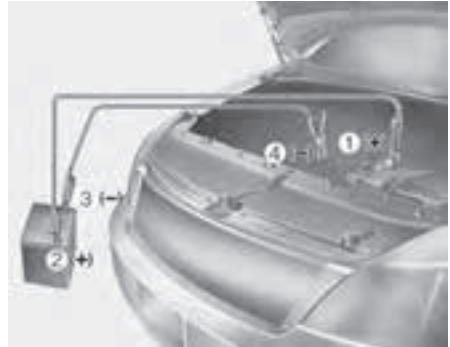

9. Connect the other end of the second jumper cable to the chassis ground of your vehicle (4).

Do not allow the jumper cables to contact anything except the correct battery or jumper terminals or the correct ground. Do not lean over the battery when making connections.

### **WARNING**

Do not connect the jumper cable to the negative (-) jumper terminal of the discharged battery. A spark could cause the battery to explode and lead to a personal injury or vehicle damage.

---

10. Start the engine of the assisting vehicle and let it run at about 2,000 RPM for a few minutes. Then start your vehicle.
11. Keep your vehicle operating for at least 30 minutes at idle or driving to make sure your battery receives enough charge to be able to start on its own after the vehicle is shut off. A completely discharged battery may require as long as 60 minutes runtime to fully recharge it. If the vehicle has run for less, the vehicle may not restart.

If your vehicle does not start after a few attempts, it probably requires service. In this event please seek qualified assistance. We recommend that your vehicle be inspected by a HYUNDAI authorised repairer.

Disconnect the jumper cables in the exact reverse order you connected them:

1. Disconnect the jumper cable from the chassis ground of your vehicle (4).
2. Disconnect the other end of the jumper cable from the black, negative (-) battery/jumper terminal of the assisting vehicle (3).
3. Disconnect the second jumper cable from the red, positive (+) battery/jumper terminal of the assisting vehicle (2).
4. Disconnect the other end of the jumper cable from the red, positive (+) jumper terminal of your vehicle (1).

### **Information**



An inappropriately disposed battery may be harmful to the environment and human health. Always dispose of a used battery according to your local law(s) or regulations.

---

### **NOTICE**

To prevent damage to your vehicle:

- Only use a 12 V power supply (battery or jumper system) to jump start your vehicle.
  - Do not attempt to jump start your vehicle by push-starting.
-

## If the engine overheats

If your temperature gauge indicates overheating, you experience a loss of power, hear loud pinging or knocking, or the engine may be overheating. If this happens, you must:

1. Pull off the road and stop as soon as it is safe to do so.
2. Place the shift lever in P (Park, for automatic transmission/intelligent variable transmission/Dual clutch mission vehicle) or neutral (for manual transmission vehicle) and set the parking brake. If the air conditioning is on, turn it off.
3. If engine coolant is running out under the vehicle or steam is coming out from the bonnet, stop the engine. Do not open the bonnet until the coolant has stopped running or the steaming has stopped. If there is no visible loss of engine coolant and no steam, leave the engine running and check to make sure the engine cooling fan is operating. If the fan is not running, turn off the engine.

### WARNING



Whilst the engine is running, keep hands, clothing, and tools away from the moving parts such as the cooling fan and drive belt to prevent serious injury.

4. Check for coolant leaking from the radiator, hoses, or under the vehicle. (If the air conditioning has been in use, it is normal for cold water to be draining from it when you stop.)
5. If engine coolant is leaking out, we recommend that you stop the engine immediately and call the nearest authorised HYUNDAI dealer for assistance.

### WARNING



Never remove the engine coolant cap or the drain plug whilst the engine and radiator are hot.

Hot coolant and steam may blow out under pressure, causing serious injury. Turn off the engine and wait until the engine cools down. Use extreme care when removing the coolant cap. Wrap a thick towel around it, and turn it counterclockwise slowly to the first stop. Step back whilst the pressure is released from the cooling system. When you are sure all the pressure has been released, press down on the cap, using a thick towel, and continue turning counterclockwise to remove it.

6. If you cannot find the cause of the overheating, wait until the engine temperature has returned to normal.  
Then, if coolant has been lost, carefully add coolant to the reservoir to bring the fluid level in the reservoir up to the halfway mark.
7. Proceed with caution, keeping alert for further signs of overheating. If overheating happens again, we recommend that you contact a HYUNDAI authorised repairer for assistance.

### CAUTION

- Serious loss of coolant indicates a leak in the cooling system. We recommend that your vehicle be inspected by a HYUNDAI authorised repairer.
- When the engine overheats from low engine coolant, suddenly adding engine coolant may cause cracks in the engine. To prevent damage, add engine coolant slowly in small quantities. It may require several refilling cycles to properly fill the engine cooling system. If necessary, we recommend that you contact a HYUNDAI authorised repairer.

## Tyre pressure monitoring system (TPMS)



- (1) Low Tyre Pressure warning light/TPMS malfunction indicator
- (2) Low tyre pressure position telltale and tyre pressure telltale

## Check tyre pressure

- You can check the tyre pressure in the Driving Assist mode in the instrument cluster.  
Refer to the "4-33" section in chapter 4.
- Tyre pressure appears after a few minutes of driving. If the tyre pressure does not appear when the vehicle is stopped, the message, "Drive to display" appears.
- The displayed tyre pressure values may differ from those measured with a tyre pressure gauge.
- You can change the tyre pressure unit from the Settings menu in the instrument cluster or infotainment system. Select:
  - User Settings > Units > tyre Pressure Unit > psi, kpa, bar (for instrument cluster)
  - Settings > General > Units > tyre Pressure Unit > psi, kpa, bar (for infotainment system)

## Tyre pressure monitoring system

### WARNING

Over-inflation or under-inflation can reduce tyre life, adversely affect vehicle handling, and lead to sudden tyre failure that may cause loss of vehicle control resulting in an collision.

Each tyre, including the spare (if provided), should be checked monthly when cold and inflated to the inflation pressure recommended by the vehicle manufacturer on the vehicle placard or tyre inflation pressure label. (If your vehicle has tyres of a different size than the size indicated on the vehicle placard or tyre inflation pressure label, you should determine the proper tyre inflation pressure for those tyres.)

As an added safety feature, your vehicle has been equipped with a tyre pressure

monitoring system (TPMS) that illuminates a low tyre pressure telltale when one or more of your tyres is significantly under-inflated. Accordingly, when the low tyre pressure telltale illuminates, you should stop and check your tyres as soon as possible, and inflate them to the proper pressure. Driving on a significantly under-inflated tyre causes the tyre to overheat and can lead to tyre failure.

Under-inflation also reduces fuel efficiency and tyre tread life, and may affect the vehicle's handling and stopping ability.

Please note that the TPMS is not a substitute for proper tyre maintenance, and it is the driver's responsibility to maintain correct tyre pressure, even if under-inflation has not reached the level to trigger illumination of the TPMS low tyre pressure telltale.

Your vehicle has also been equipped with a TPMS malfunction indicator to indicate when the system is not operating properly. The TPMS malfunction indicator is combined with the low tyre pressure telltale. When the system detects a malfunction, the telltale flashes for approximately one minute and then remains continuously illuminated. This sequence continues upon subsequent vehicle start-ups as long as the malfunction exists.

When the malfunction indicator is illuminated, the system may not be able to detect or signal low tyre pressure as intended. TPMS malfunctions may occur for a variety of reasons, including the installation of replacement or alternate tyres or wheels on the vehicle that prevent the TPMS from functioning properly.

Always check the TPMS malfunction telltale after replacing one or more tyres or wheels on your vehicle to ensure that the replacement or alternate tyres and wheels allow the TPMS to continue to function properly.

### NOTICE

We recommend that the system inspected by an authorised HYUNDAI dealer if:

1. The Low tyre Pressure Telltale/TPMS Malfunction Indicator does not illuminate for 3 seconds when the ignition switch is moved to the ON position or the engine is running.
2. The TPMS Malfunction Indicator remains illuminated after blinking for about 1minute.
3. The Low tyre Pressure Position Telltale remains illuminated.

### Low tyre pressure warning light

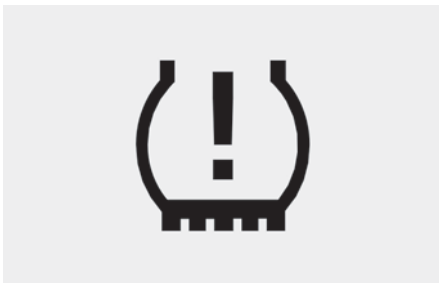

### Low tyre pressure position and tyre pressure telltale

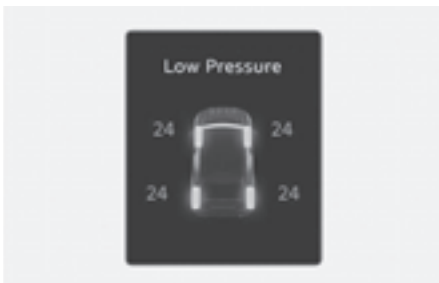

TPMS is not a substitute for manually checking the tyre pressure with a tyre

gauge. Changes in temperature affect tyre pressure. Refer to "Check tyre pressure" in the Maintenance chapter for proper tyre inflation and tyre pressure measurement procedure.

When the tyre pressure monitoring system warning indicators illuminate and a warning message appears on the cluster display, one or more of your tyres are significantly under-inflated. The Low tyre Pressure Position Telltale indicates which tyre is significantly under-inflated by illuminating the corresponding position light.

If either telltale illuminates, immediately reduce the vehicle speed, avoid hard cornering and anticipate increased stopping distances. Stop and check your tyres as soon as possible. Inflate the tyres to the proper pressure as indicated on the vehicle's placard or tyre inflation pressure label located on the driver's side center pillar outer panel.

If you cannot reach a service station or the tyre cannot hold the newly added air, replace the low pressure tyre with the spare tyre.

The Low tyre Pressure Telltale remains on and the TPMS Malfunction Indicator may blink for one minute and then remain illuminated (when the vehicle is driven about 10 minutes at the speed above 25 km/h (15.5 mph)) until you have the low pressure tyre repaired and replaced on the vehicle.

**⚠ WARNING**

In winter or cold weather, the Low tyre Pressure Telltale may be illuminated if the tyre pressure was adjusted to the recommended tyre inflation pressure in warm weather. It does not mean your TPMS is malfunctioning because the decreased temperature leads to a proportional lowering of tyre pressure.

When you drive your vehicle from a warm area to a cold area or from a cold area to a warm area, or the outside temperature is greatly higher or lower, check the tyre inflation pressure and adjust the tyres to the recommended tyre inflation pressure.

**⚠ WARNING**

Low pressure damage

Significantly low tyre pressure makes the vehicle unstable and may contribute to loss of vehicle control and increased braking distances.

Continued driving on low pressure tyres may cause the tyres to overheat and fail.

**TPMS malfunction indicator**

The TPMS malfunction indicator will illuminate after it blinks for approximately one minute when there is a problem with the tyre Pressure Monitoring System.

We recommend that the system be checked by an authorised HYUNDAI dealer.

**NOTICE**

If there is a malfunction with the TPMS, the individual tyre pressures on the cluster display are not be available. We recommend that the system inspected by an authorised HYUNDAI dealer as soon as possible.

**NOTICE**

The TPMS Malfunction Indicator may illuminate after blinking for one minute if the vehicle is near electric power supply cables or radio transmitters such as police stations, government and public offices, broadcasting stations, military installations, airports, transmitting towers, etc.

Additionally, the TPMS Malfunction Indicator may illuminate if snow chains are used or if electronic devices such as computers, chargers, remote starters, navigation, etc. are near the vehicle. This may interfere with normal operation of the TPMS.

### Changing a tire with TPMS

If you have a flat tire, the Low Tire Pressure and Position telltales will come on.

We recommend that you have the flat tire repaired by an authorised HYUNDAI dealer as soon as possible or replace the flat tire with the spare tire.

#### NOTICE

Do not use a puncture-repair kit not approved by HYUNDAI. Tire sealant not approved by HYUNDAI or the equivalent sealant specified for your vehicle may damage the tire pressure sensor.

The spare tire (if equipped) does not come with a tire pressure monitoring sensor. When the low pressure tire or the flat tire is replaced with the spare tire, the Low Tire Pressure Telltale remains on.

Also, the TPMS Malfunction Indicator illuminates after blinking for one minute if the vehicle is driven at the speed above 25 km/h (15.5 mph) for about 10 minutes.

Once the original wheel equipped with a tire pressure monitoring sensor is reinflated to the recommended pressure and reinstalled on the vehicle, the Low Tire Pressure Telltale and TPMS Malfunction Indicator goes off within a few minutes of driving.

If the indicators do not turn off after a few minutes, visit an authorised HYUNDAI dealer.

Each wheel is equipped with a tire pressure sensor mounted inside the tire behind the valve stem (except for the spare tire). You must use TPMS specific wheels. It is recommended that you always have your tires serviced by an authorised HYUNDAI dealer.

You may not be able to identify a tire with low pressure by simply looking at it. Always use a good quality tire pressure gauge to measure. Note that a tire that is hot (from being driven) has a higher pressure measurement than a tire that is cold.

A cold tire means the vehicle has been sitting for 3 hours and driven for less than 1.6 km (1 mi.) in that 3 hour period.

Allow the tire to cool before measuring the inflation pressure. Always make sure the tire is cold before inflating to the recommended pressure.

---

#### WARNING

We recommend that the system inspected by an authorised HYUNDAI dealer if:

- The TPMS cannot alert you to severe and sudden tire damage caused by external factors such as nails or road debris.
  - If you feel any vehicle instability, immediately take your foot off the accelerator pedal, apply the brakes gradually with light force, and slowly move to a safe position off the road.
- 

#### WARNING

Tampering with, modifying, or disabling the Tire Pressure Monitoring System (TPMS) components may interfere with the system's ability to warn the driver of low tire pressure conditions and/or TPMS malfunctions and may void the warranty.

---



## If you have a flat tyre (With spare tyre)

 if equipped

### WARNING

Follow the instructions in this section when replacing a tyre to reduce the risk of serious injury or death. Changing a tyre can be dangerous.

### Jack and tools



- (1) Jack handle
- (2) Jack
- (3) Wheel lug wrench
- (4) Towing hook

The jack, jack handle, wheel lug nut wrench and towing hook are stored in the cargo area under the luggage box cover.

The jack is provided for emergency tyre changing only.



Turn the winged hold down bolt counterclockwise to remove the spare tyre.

Store the spare tyre in the same compartment by turning the winged hold down bolt clockwise.

To prevent the spare tyre and tools from “rattling”, store them in their proper locations.

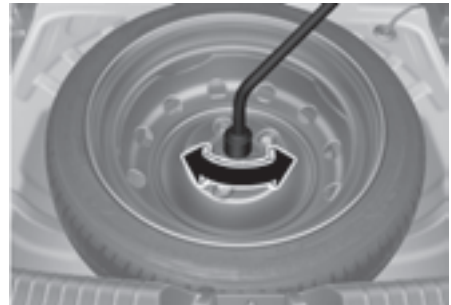

If it is hard to loosen the tyre hold down wing bolt by hand, you can loosen it easily using the wheel lug wrench.

Turn the tyre hold down wing bolt counterclockwise with the wheel lug wrench.

### Changing tyres

#### **WARNING**

Because the vehicle may slip or roll off of a jack causing serious injury or death, take the following safety precautions:

- NEVER place any portion of your body under the vehicle that is supported by a jack.
- NEVER attempt to change a tyre in the lane of traffic. ALWAYS move the vehicle completely off the road on a level, firm ground away from traffic before trying to change a tyre. If you cannot find a level, firm place off the road, call a towing service for assistance.
- ONLY use the jack provided with the vehicle.
- ALWAYS place the jack on the designated jacking positions on the vehicle and NEVER on the bumpers or any other part of the vehicle for jacking support.
- Do not start or run the engine whilst the vehicle is on the jack.
- Do not allow anyone to remain in the vehicle whilst it is on the jack.
- Keep children away from the road and the vehicle.

Keep the following steps to change your vehicle's tyre:

1. Park on a level, firm surface.
2. Shift the gear to P (Park), apply the parking brake, and move the Engine Start/Stop button to the OFF position.
3. Press the hazard warning flasher button.
4. Remove the wheel lug wrench, jack, jack handle, and spare tyre from the vehicle.
5. Block both the front and rear of the tyre diagonally opposite of the tyre you are changing.
6. Loosen the wheel nuts counterclockwise one turn each in the order shown below, but do not remove any wheel nuts until the tyre has been raised off of the ground.



- Place the jack at the designated jacking position under the frame closest to the tyre you are changing. The jacking positions are plates welded to the frame with two notches. Never jack any other position or part of the vehicle to prevent the vehicle slipping off of the jack or damaging the vehicle.



- Insert the jack handle into the jack and turn it clockwise, raising the vehicle until the tyre clears the ground. Make sure the vehicle is stable on the jack.



- Loosen the wheel nuts with the wheel lug wrench and remove them with your fingers. Remove the wheel from the studs and lay it flat on the ground out of the way. Remove any dirt or debris from the studs, mounting surfaces, and spare tyre.

### WARNING

Because the wheels may have sharp edges, handle them carefully to avoid possible severe injury. Before putting the wheel into place, make sure that there is nothing on the hub or wheel (such as mud, tar, gravel, etc.) that interferes with the wheel from fitting solidly against the hub.

If there is, remove it. If there is not good contact on the mounting surface between the wheel and hub, the wheel nuts may come loose and cause the loss of a wheel. Loss of a wheel may result in loss of control of the vehicle. This may cause serious injury or death.

- Install the spare tyre onto the studs of the hub.

- Tighten the wheel nuts with your fingers onto the studs with the smaller end of the wheel nuts closest to the wheel.

- Lower the vehicle to the ground by turning the jack handle counterclockwise.

- Use the wheel lug nut wrench to tighten the wheel nuts in the order shown. Double-check each wheel nut until they are tight. After changing tyres, we recommend that a HYUNDAI authorised repairer tighten the lug nuts to their proper torque as soon as possible.

Tighten wheel nuts to 79-94 lbf-ft (11-13 kgf-m).



If you have a tyre gauge, check the tyre pressure (refer to the “Tyres and wheels” section in chapter 2 for tyre pressure instructions). If the spare tyre pressure is lower or higher than the recommended, drive slowly to the nearest service station and adjust it to the recommended pressure.

Always reinstall the valve cap after checking or adjusting the tyre pressure. If the cap is not replaced, air may leak from the tyre. If you lose a valve cap, buy another and install it as soon as possible. After changing tyres, secure the flat tyre and return the jack and tools to their proper storage locations.

### NOTICE

Check the tyre pressure as soon as possible after installing a spare tyre. Adjust it to the recommended pressure.

### WARNING

Your vehicle has metric threads on the studs and wheel nuts. During tyre changing, make sure that the wheel nuts that were removed are reinstalled. If you have to replace your wheel nuts, make sure they have metric threads to avoid damaging the studs and make sure the wheel is properly secured to the hub. We recommend that you contact a HYUNDAI authorised repairer for assistance.

If any of the equipment such as the jack, wheel nuts, studs, or other equipment is damaged or in poor condition, do not attempt to change the tyre and call for assistance.

### Use of compact spare tyres

If equipped

Compact spare tyres are designed for emergency use only. Drive carefully on the compact spare tyre and always follow the safety precautions.

### WARNING

To prevent compact spare tyre failure and loss of control, possibly resulting in a collision:

- Use the compact spare tyre only in an emergency.
- NEVER operate your vehicle over 80 km/h (50 mph).
- Do not exceed the vehicle’s maximum load rating or the load carrying capacity shown on the sidewall of the compact spare tyre.
- Do not use the compact spare tyre continuously. Repair or replace the original tyre as soon as possible to avoid failure of the compact spare tyre.

When driving with the compact spare tyre mounted to your vehicle:

- Do not take this vehicle through an automatic car wash after the compact spare tyre has been installed.
- Do not use the compact spare tyre on any other vehicle because this tyre has been designed especially for your vehicle.
- The compact spare tyre’s tread life is shorter than a regular tyre. Inspect your compact spare tyre regularly and replace worn compact spare tyres with the same size and design, mounted on the same wheel.

- Do not use more than one compact spare tyre at a time.
- Do not tow a trailer whilst the compact spare tyre is installed.

### **NOTICE**

When the original tyre and wheel are repaired and reinstalled on the vehicle, the wheel nut torque must be set correctly. The correct wheel nut tightening torque is 79-94 lbf·ft (11-13 kgf·m).

---

### **CAUTION**

To prevent damaging the compact spare tyre and your vehicle:

- Drive slowly enough for the road conditions to avoid all hazards, such as a potholes or debris.
  - Avoid driving over obstacles. The compact spare tyre diameter is smaller than the diameter of a conventional tyre and reduces the ground clearance about 1inch (25 mm).
  - Do not use tyre chains on the compact spare tyre. Because of the smaller size, a tyre chain will not fit properly.
  - Do not use the compact spare tyre on any other wheels, nor should standard tyres, snow tyres, wheel covers or trim rings be used with the compact spare wheel.
  - Do not suddenly accelerate or decelerate (0-40 km/h (0-25 mph)) in any driving mode. It may cause leakage of transfer oil.
-

## Jack label

Type A

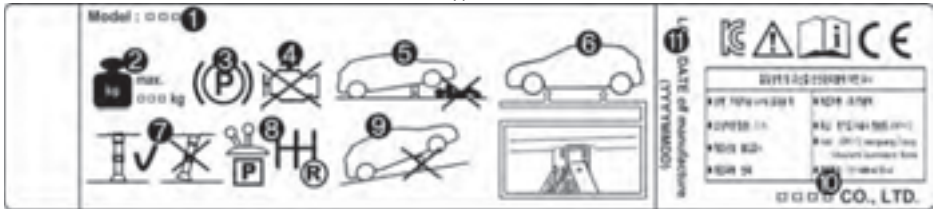

Type B

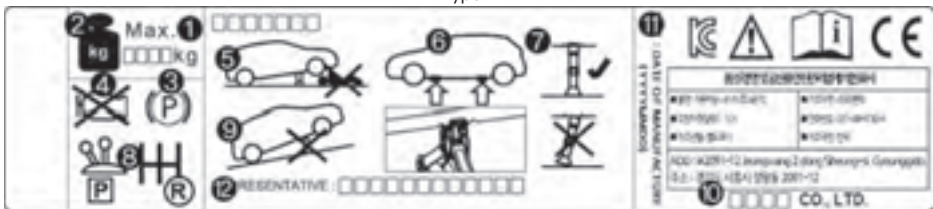

- (1) Model Name
- (2) Maximum allowable load
- (3) Always apply the parking brake before using a jack.
- (4) Always turn off the engine before using a jack.
- (5) Never put any portion of your body under the vehicle supported by a jack.
- (6) Only use the designated jacking locations on the frame.
- (7) When supporting the vehicle, have the base plate of the jack flat on the ground under the lifting point.
- (8) Shift into R (Reverse) gear with manual transmission or shift the gear to the P (Park) position on vehicles with automatic transmission, dual clutch transmission, and intelligent variable transmission.
- (9) Do not jack the vehicle on an incline. Only jack the vehicle on a firm level ground.
- (10) Jack manufacturer
- (11) Production date
- (12) Representative company and address

The actual Jack label in the vehicle may differ from the illustration.

For more detailed specifications, refer to the label attached to the jack.

## EC declaration of conformity for jack

**Moonlight AUTO PARTS LTD.**  
 Unit No. 42, Sanyal Road,  
 100, Sanyal Road, Techno Park, Chennai,  
 Tamil Nadu, India  
 E-MAIL: moonlight@moonlight.co.in

DATE: 26-08-2012

**CE**

**EC Declaration of Conformity**  
 According to EC Machinery Directive 2006/42/EC

We Moonlight Auto Parts Limited  
 as a manufacturer, Manufacturer, Importer/Exporter/Supplier, declare that  
 the product is:

Address under our sole responsibility for the product  
 Product: Jack  
 Type/Designation: 150 kg, 400 kg, 600 kg  
 Application: All purpose  
 Year of Manufacture: 2012

In which the declaration relates to conformity with the following standards or other technical specifications:

EN 12534-1:2010 Safety of machinery: Design principles for design, fit assessment and risk reduction  
 EN 12534-2:2010 Safety of machinery: Basic concepts, general principles for design  
 EN 12534-3:2010 Safety of machinery: Basic concepts, general principles for design  
 EN 12534-4:2010 Safety of machinery: Basic concepts, general principles for design  
 EN 12534-5:2010 Safety of machinery: Basic concepts, general principles for design

Following the provisions of the Directive:

EN 12534-1:2010 Annex A to the requirements of the Annex of Machinery Directive 2006/42/EC, para. 2.2.2.2

Place of Issue: Chennai, Tamil Nadu, India  
 Date of Issue: 26-08-2012  
 Signature: [Signature]

**MK MK TRON AUTOPARTS PRIVATE LIMITED**  
 (Incorporated in India)  
 2/10, Sanyal Road, Techno Park, Chennai, Tamil Nadu, India

DATE: 26-08-2012

**EC DECLARATION OF CONFORMITY**  
 According to EC Machinery Directive 2006/42/EC

We MK Tron Autoparts Private Limited as a manufacturer, Manufacturer, Importer/Exporter/Supplier, declare that the product is:

Address under our sole responsibility for the product  
 Product: Jack  
 Type/Designation: 150 kg, 400 kg, 600 kg  
 Application: All purpose  
 Year of Manufacture: 2012

In which the declaration relates to conformity with the following standards or other technical specifications:

EN 12534-1:2010 Safety of machinery: Design principles for design, fit assessment and risk reduction  
 EN 12534-2:2010 Safety of machinery: Basic concepts, general principles for design  
 EN 12534-3:2010 Safety of machinery: Basic concepts, general principles for design  
 EN 12534-4:2010 Safety of machinery: Basic concepts, general principles for design  
 EN 12534-5:2010 Safety of machinery: Basic concepts, general principles for design

Following the provisions of the Directive:

EN 12534-1:2010 Annex A to the requirements of the Annex of Machinery Directive 2006/42/EC, para. 2.2.2.2

Place of Issue: Chennai, Tamil Nadu, India  
 Date of Issue: 26-08-2012  
 Signature: [Signature]

CONTACT PERSON	LEGAL OFFICER	NEW CUSTOMER SERVICE
Mr. S. S. Sanyal	Mr. S. S. Sanyal	Mr. S. S. Sanyal
Mr. S. S. Sanyal	Mr. S. S. Sanyal	Mr. S. S. Sanyal
Mr. S. S. Sanyal	Mr. S. S. Sanyal	Mr. S. S. Sanyal
Mr. S. S. Sanyal	Mr. S. S. Sanyal	Mr. S. S. Sanyal

Approved/Issued By: S. S. Sanyal, Director, MK Tron Autoparts Private Limited, Chennai, Tamil Nadu, India

## Towing

### Towing service

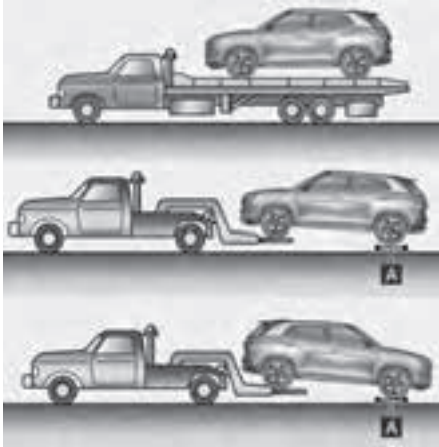

[A] Dollies

If towing is necessary, we recommend that you contact a HYUNDAI authorised repairer or a commercial tow-truck service.

2WD vehicles can be towed with the rear wheels on the ground (without dollies) and the front wheels off the ground.

The use of wheel dollies or flatbed is recommended. If any of the loaded wheels or suspension components are damaged or the vehicle is towed with the front wheels on the ground, use a towing dolly under the front wheels.



### CAUTION

To prevent damage when towing:

- Do not tow the vehicle with the front wheels on the ground as this may cause damage to the vehicle and transmission.
- Do not tow with sling-type equipment. Use a wheel lift or flatbed equipment.
- Do not tow the vehicle with four wheels in contact with the ground if it is the vehicle equipped with IVT, AT and DCT. Otherwise, the transmission will be seriously damaged. Also, make sure not to tow the vehicle connecting it with other vehicles including camper vans.



When towing your vehicle without wheel dollies:

1. Place the ignition switch or Engine Start/Stop button in the ACC position.
2. Place the shift gear in N (Neutral).
3. Release the parking brake.

### **WARNING**

If your vehicle is equipped with a rollover sensor, place the ignition switch or Engine Start/Stop button in the OFF or ACC position when the vehicle is being towed. The side impact and curtain air bag may deploy if the sensor detects the situation as a rollover.

### **Information**

Always shift the gear to N (Neutral) to prevent damage to the transmission before towing.

## Removable towing hook

Front

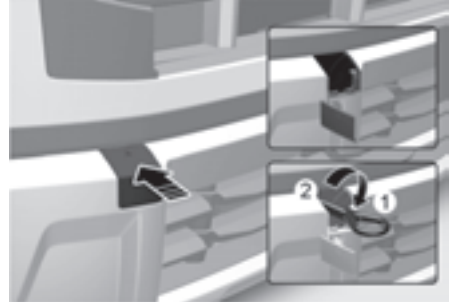

Rear



- (1) Install
- (2) Remove

1. Open the tailgate and remove the towing hook from the tool case.
2. Remove the hole cover by pressing at the ▲ mark on the cover on the bumper.
3. Install the towing hook by turning it clockwise into the hole until it is fully secured.
4. Remove the towing hook and install the cover after use.

### **NOTICE**

Failure to properly tighten the towing hook may result in vehicle damage and deformation of related parts.

### CAUTION

Make sure the towing hook is tightened properly. If not, during towing the towing hook may be thrown off the vehicle resulting in serious injury or accident.

## Emergency towing

Front



Rear

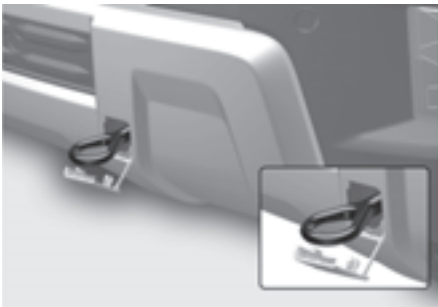

If emergency towing is necessary, we recommend that you contact a HYUNDAI authorised repairer or a commercial tow-truck service.

If tow-truck service is not available in an emergency, your vehicle can be temporarily towed using a cable or chain secured to the removable towing hook at the front (or rear) of the vehicle.

Perform emergency towing using cables or chains on hard-surfaced roads for a short distance and at low speeds. The wheels, axles, powertrain, steering, and brakes must all be in good working condition.

### WARNING

Use extreme caution when towing the vehicle with a cable or chain. A driver must be in the vehicle to steer it and operate the brakes. Passengers other than the driver must not be in the vehicle.

Always follow these emergency towing precautions:

- Place the ignition switch or Engine Start/Stop button to the ACC position so the steering wheel is not locked.
- Shift the gear in N (Neutral).
- Release the parking brake.
- Depress the brake pedal with more force than normal because you have reduced braking performance.
- More steering effort is required because the power steering system will be disabled.
- Use a vehicle heavier than your own to tow your vehicle.
- The drivers of both vehicles must communicate with each other frequently.
- Before emergency towing, check that the removable hook is not broken or damaged.
- Fasten the towing cable or chain securely to the hook.
- Do not jerk the cables, chains, or removable hook. Apply steady and even force.

- Use a towing cable or chain less than 16 ft. (5 m) long. Attach a white or red cloth (about 12 inches (30 cm) wide) in the middle of the cable or chain for easy visibility.

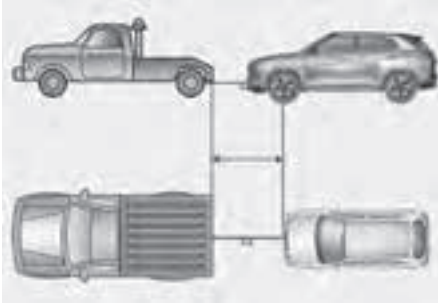

- Drive carefully so the towing cable or chain remains tight during towing.
- Before towing, check the Manual Transmission, Dual Clutch Transmission for fluid leaks under your vehicle. If the transmission fluid is leaking, flatbed equipment or a towing dolly must be used.

### NOTICE

Accelerate or decelerate the vehicle in a slow and gradual manner whilst maintaining tension on the tow rope or chain to start or drive the vehicle. Otherwise tow hooks and the vehicle may be damaged.

### NOTICE

To avoid damage to your vehicle and vehicle components when towing:

- Always pull straight ahead when using the towing hooks. Do not pull from the side or at a vertical angle.
- Do not use the towing hooks to pull the vehicle out of mud, sand, or other conditions from which the vehicle cannot be driven out under its own power.
- Limit the vehicle speed to 15 km/h (10 mph) and drive less than 1.5 km (1 mi.) when towing to avoid serious damage to transmission (if equipped with DCT/IVT/AT).
- The vehicle should be towed at a speed of 25 km/h (15 mph) or less within the distance of 20 km (12 mi.) (if equipped with Manual Transmission).

### Emergency commodity

 If equipped

Your vehicle is equipped with emergency commodities to help you respond to emergency situation.

#### First aid kit

Supplies for use in giving first aid such as scissors, bandage, and adhesive tape, etc. are provided.

#### Triangle reflector

Place the triangle reflector on the road to warn oncoming vehicles during emergencies, such as when the vehicle is parked by the roadside due to problems.

# 9. Maintenance

---

Engine compartment .....	9-4
Maintenance services .....	9-7
Owner's responsibility .....	9-7
Owner maintenance precautions .....	9-7
Owner maintenance .....	9-8
Owner maintenance schedule .....	9-8
Scheduled maintenance services.....	9-10
Normal maintenance schedule (Petrol Engine).....	9-11
Maintenance under severe usage and low mileage conditions (Petrol engine) ...	9-15
Normal maintenance schedule (Diesel Engine) .....	9-17
Maintenance under severe usage and low mileage conditions (Diesel engine)...	9-21
Explanation of scheduled maintenance items .....	9-23
Engine oil and filter .....	9-23
Drive belts.....	9-23
Fuel lines, fuel hoses and connections.....	9-23
Fuel Filter .....	9-23
Vapour hose and fuel filler cap .....	9-23
Vacuum crankcase ventilation hoses .....	9-23
Air cleaner filter .....	9-24
Spark plugs.....	9-24
Valve clearance .....	9-24
Cooling system.....	9-24
Engine coolant .....	9-24
Manual transmission fluid .....	9-24
Automatic transmission fluid .....	9-24
Dual clutch transmission fluid.....	9-24
Intelligent variable transmission fluid .....	9-25
Brake hoses and lines .....	9-25
Brake/clutch fluid .....	9-25
Parking brake.....	9-25
Brake discs, pads, calipers and rotors .....	9-25
Exhaust pipe and muffler .....	9-25
Suspension mounting bolts.....	9-26
Steering gear box, linkage & boots/lower arm ball joint.....	9-26
Drive shafts and related .....	9-26
Air conditioning refrigerant.....	9-26
Engine oil.....	9-26



- Checking the engine oil level (Petrol engine)..... 9-26
- Checking the engine oil level (Diesel engine) ..... 9-28
- Checking the engine oil and filter ..... 9-29
- Engine coolant ..... 9-30
  - Checking the coolant level ..... 9-30
  - Changing coolant ..... 9-32
- Brake/clutch fluid ..... 9-32
  - Checking the brake/clutch fluid level ..... 9-32
- Washer fluid..... 9-33
  - Checking the washer fluid level ..... 9-33
- Parking brake..... 9-34
  - Checking the parking brake..... 9-34
- Fuel filter (for diesel engine) ..... 9-34
  - Draining water from fuel filter ..... 9-34
  - Fuel filter cartridge replacement ..... 9-34
- Air cleaner..... 9-35
  - Filter replacement ..... 9-35
- Cabin air filter ..... 9-36
  - Filter inspection ..... 9-36
  - Filter replacement ..... 9-36
- Wiper blades..... 9-37
  - Blade inspection ..... 9-37
  - Blade replacement ..... 9-37
- Battery ..... 9-39
  - For best battery service ..... 9-41
  - Battery capacity label ..... 9-42
  - Battery recharging ..... 9-42
  - Reset items ..... 9-43
- Tyres and wheels..... 9-44
  - Tyre care ..... 9-44
  - Recommended cold tyre inflation pressures ..... 9-44
  - Check tyre inflation pressure..... 9-45
  - Tyre rotation ..... 9-46
  - Wheel alignment and tyre balance ..... 9-46
  - Tyre replacement ..... 9-47

# 9. Maintenance

---

Wheel replacement.....	9-48
Tyre traction .....	9-48
Tyre maintenance .....	9-48
Tyre sidewall labelling .....	9-48
Low aspect ratio tyres .....	9-51
Fuses.....	9-52
Instrument panel fuse replacement .....	9-53
Engine compartment panel fuse replacement.....	9-53
Fuse/relay panel description.....	9-55
Light bulbs.....	9-68
Headlight, Position light, Turn signal light, Daytime running light (DRL) replacement .....	9-69
Side repeater light replacement .....	9-71
Rear combination light replacement.....	9-71
Backup light replacement .....	9-73
High mounted stop light replacement .....	9-74
License plate light replacement .....	9-74
Interior light replacement .....	9-75
Appearance care.....	9-76
Exterior care .....	9-76
Interior care .....	9-81
Emission control system .....	9-84
Crankcase emission control system .....	9-84
Evaporative emission control system.....	9-84
Exhaust emission control system .....	9-85

## Engine compartment

Smartstream G1.5 MPI

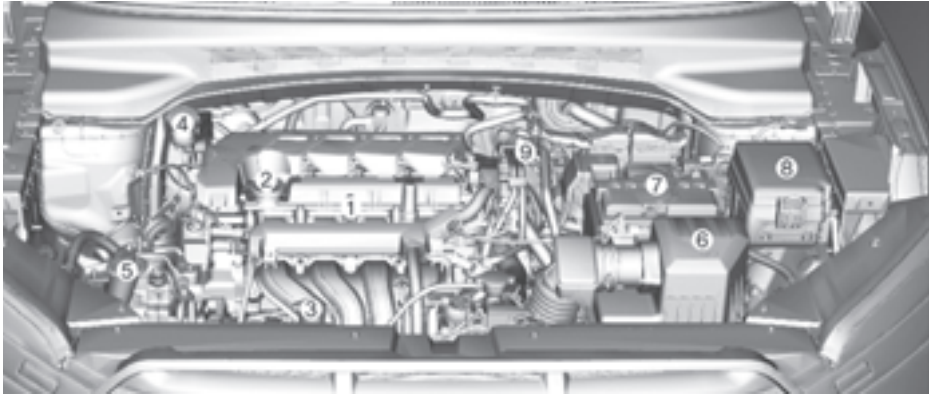

The actual engine compartment in the vehicle may differ from the illustration.

- (1) Engine oil dipstick
- (2) Engine oil filler cap
- (3) Engine coolant reservoir/Engine coolant cap
- (4) Brake/clutch fluid reservoir
- (5) Windscreen washer fluid reservoir
- (6) Air cleaner
- (7) Battery
- (8) Fuse box



## Smartstream G1.5 T-GDi

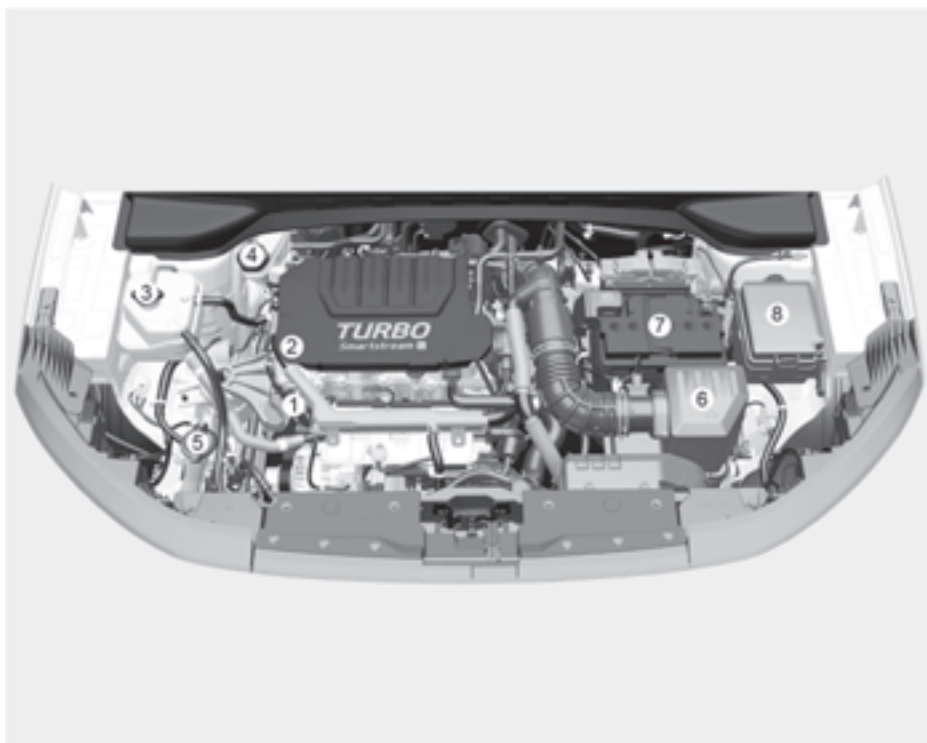

**The actual engine compartment in the vehicle may differ from the illustration.**

- (1) Engine oil dipstick
- (2) Engine oil filler cap
- (3) Engine coolant reservoir/Engine coolant cap
- (4) Brake/clutch fluid reservoir
- (5) Windscreen washer fluid reservoir
- (6) Air cleaner
- (7) Battery
- (8) Fuse box

Diesel 1.5 VGT

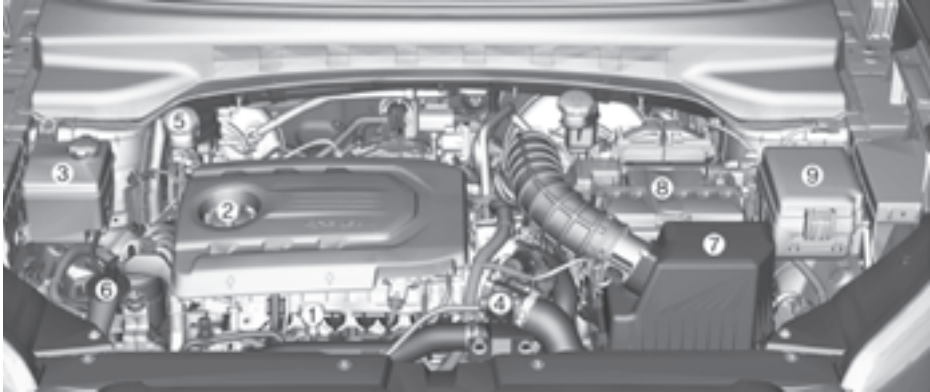

**The actual engine compartment in the vehicle may differ from the illustration.**

- (1) Engine oil dipstick
- (2) Engine oil filler cap
- (3) Engine coolant reservoir/Engine coolant cap
- (4) Radiator cap
- (5) Brake/clutch fluid reservoir
- (6) Windscreen washer fluid reservoir
- (7) Air cleaner
- (8) Battery
- (9) Fuse box

## Maintenance services

You should exercise the utmost care to prevent damage to your vehicle and injury to yourself whenever performing any maintenance or inspection procedures.

We recommend that you have the vehicle maintained and repaired by a HYUNDAI authorised repairer. A HYUNDAI authorised repairer meets HYUNDAI's high service quality standards and receives technical support from HYUNDAI in order to provide you with a high level of service satisfaction.

## Owner's responsibility

Maintenance service and record retention are the owner's responsibility.

You should retain documents that show proper maintenance has been performed on your vehicle in accordance with the Maintenance schedule at the Service Passport in your vehicle. You need this information to establish your compliance with the servicing and maintenance requirements of your vehicle warranties.

Detailed warranty information is provided in your Service passport.

Repairs and adjustments required as a result of improper maintenance or a lack of required maintenance are not covered.

## Owner maintenance precautions

Inadequate, incomplete or insufficient servicing may result in operational problems with your vehicle that could lead to vehicle damage, an accident, or personal injury. This chapter provides instructions only for the maintenance items that are easy to perform. Several maintenance procedures can only be done with special tools, therefore we recommend to contact a HYUNDAI authorised repairer.

Your vehicle should not be modified in any way. Such modifications may adversely affect the performance, safety or durability of your vehicle and may, in addition, violate conditions of the limited warranties covering the vehicle.

### NOTICE

Improper owner maintenance during the warranty period may affect warranty coverage. For information, read the separate Service passport provided with the vehicle. If you are unsure about any service or maintenance procedure we recommend to contact a HYUNDAI authorised repairer.

## Owner maintenance

### WARNING

Performing maintenance on the vehicle can be dangerous. If you lack sufficient knowledge, experience, or proper tools and equipment to do the work, we recommend that it done by a HYUNDAI authorised repairer.

ALWAYS follow these precautions for performing maintenance work:

- Park your vehicle on level ground. Shift the vehicle to P (Park), apply the parking brake, and press the Engine Start/Stop button to the OFF position.

- Block the tyres (front and back) to prevent the vehicle from moving.

Remove loose clothing or jewellery that can become entangled in moving parts.

- If you must run the engine during maintenance, do it in an outdoor area or in an area with plenty of ventilation.
- Keep flames, sparks, or smoking materials away from the battery and fuel-related parts.

### WARNING

#### Touching metal parts



Do not touch metal parts (including strut bars) whilst the engine is operating or hot to prevent serious injury. Turn off the engine and wait until the metal parts cool down before working on the vehicle.

---

The following lists are vehicle checks and inspections that should be performed by the owner or a HYUNDAI authorised repairer at the frequencies indicated to help ensure safe and dependable operation of your vehicle.

Any adverse conditions should be brought to the attention of your authorised HYUNDAI dealer as soon as possible.

These Owner Maintenance vehicle checks are generally not covered by warranties and you may be charged for labour, parts and lubricants used.

## Owner maintenance schedule

### *When you stop for fuel:*

- Check the coolant level in the engine coolant reservoir.
- Check the windscreen washer fluid level.
- Check for low or under-inflated tyres.

### WARNING

Be careful when checking your coolant level when the engine is hot. This may result in coolant being blown out of the opening and cause serious burns and other injuries.

---

***Whilst operating your vehicle:***

- Note any changes in the sound of the exhaust or any smell of exhaust fumes in the vehicle.
- Check for vibrations in the steering wheel. Notice if there is any increased steering effort or looseness in the steering wheel, or change in its straight-ahead position.
- Notice if your vehicle constantly turns slightly or “pulls” to one side when travelling on smooth, level road.
- When stopping, listen and check for unusual sounds, pulling to one side, increased brake pedal travel or “hard-to-push” brake pedal.
- If any slipping or changes in the operation of your transmission occurs, check the transmission fluid level.
- Check the transmission P (Park) function.
- Check the parking brake.
- Check for fluid leaks under your vehicle (water dripping from the air conditioning system during or after use is normal).

***At least monthly:***

- Check coolant level in the engine coolant reservoir.
- Check the operation of all exterior lights, including the stoplights, turn signals and hazard warning flashers.
- Check the inflation pressures of all tyres including the spare for tyres that are worn, show uneven wear, or are damaged.
- Check for loose wheel lug nuts.

***At least twice a year: (for example, every Spring and Autumn)***

- Check radiator, heater and air conditioning hoses for leaks or damage.
- Check windscreen washer spray and wiper operation. Clean wiper blades with a clean cloth dampened with washer fluid.
- Check headlight alignment.
- Check muffler, exhaust pipes, shields and clamps.
- Check the seat belts for wear and function.

***At least once a year:***

- Clean body and door drain holes.
- Lubricate door hinges and bonnet hinges.
- Lubricate door and bonnet locks and latches.
- Lubricate door rubber weather strips.
- Check the air conditioning system.
- Inspect and lubricate automatic transmission linkage and controls.
- Clean the battery and terminals.
- Check the brake fluid level.

## Scheduled maintenance services

- \*1 Check the engine oil level and leak every 500 km (350 miles) or before starting a long trip.
- \*2 Driving in ambient temperature over 40°C (104°F) or driving at constant highway speeds must conform the severe driving conditions.
- \*3 The engine oil level should be checked regularly and maintained properly. Operating with an insufficient amount of oil can damage the engine, and such damage is not covered by warranty.
- \*4 Inspect for excessive valve noise and/or engine vibration and adjust if necessary. We recommend that an authorized HYUNDAI dealer should perform the operation.
- \*5 When adding coolant, use only deionized water or soft water for your vehicle and never mix hard water in the coolant filled at the factory. An improper coolant mixture can result in serious malfunction or engine damage.
- \*6 Manual/Auto/iVT/DCT transaxle fluid should be changed anytime the vehicle has been submerged in water.
- \*7 It is applicable only when using a qualified fuel <"EN228 or equivalent">. If the same is not available, one bottle of additive is recommended. Additives are available from your authorised HYUNDAI dealer along with information on how to use them. Do not mix other additives.
- \*8 Fuel filter is considered to be maintenance free but the quality of fuel used may impact the frequency of maintenance needed. If there are some important safety matters like fuel flow restriction, surging, loss of power, hard starting problem, etc., it is recommended to contact authorised HYUNDAI dealer to replace the filter immediately regardless of maintenance schedule.
- \*9 Inspect drive belt tensioner, idler & alternator pulley, starter & all chassis electrical items. Correct or replace if necessary.
- \*10 For your convenience, it can be replaced prior to it's interval when you do maintenance of other items.
- \*11 Adjust alternator and power steering (and water pump drive belt) and air conditioner drive belt (if equipped). Inspect if necessary, correct or replace.

## Normal maintenance schedule (Petrol Engine)

I: Inspect and if necessary, adjust, correct, clean or replace.

C: Clean or replace (if necessary).

R: Replace or change.

MAINTENANCE INTERVAL		Number of months or driving distance, whichever comes first									
		Months	2	12	24	36	48	60	72	84	96
		Kms x 1,000	1.5	10	20	30	40	50	60	70	80
MAINTENANCE ITEM											
<b>ENGINE BAY</b>											
Engine oil & filter *1 *2 *3 *4		I	R	R	R	R	R	R	R	R	
Drive belt		-	-	-	I	-	-	I	-	-	
Air cleaner filter	Smartstream G1.5 MPI	C	C	C	R	C	C	R	C	C	
	Smartstream G1.5 T-GDi	C	C	R	C	R	C	R	C	R	
Battery condition & specific gravity		I	I	I	I	I	I	I	I	I	
Spark Plugs *10	Smartstream G1.5 MPI	Replace every 165,000 km (110,000 mi.)									
	Smartstream G1.5 T-GDi	Replace every 75,000 km (50,000 mi.)									
Vacuum Hose		-	-	-	I	-	-	I	-	-	
Idler/ damper pulley/ Adj. Bolt		Inspect when replacing the drive belt or timing belt/chain									
Brake/Clutch fluid		I	I	R	I	I	R	I	I	I	
Engine Coolant (topup & specify gravity)*5		Inspect at every service; Replace first at 1,00,000 Km or 60 months; then at every 40,000 Km or 24 months									
Manual /Automatic /IVT /DCT fluid (if equipped) *6		No check, No service required									

## Maintenance

---

I: Inspect and if necessary, adjust, correct, clean or replace.

C: Clean or replace (if necessary).

R: Replace or change.

MAINTENANCE INTERVAL	Number of months or driving distance, whichever comes first									
	Months	2	12	24	36	48	60	72	84	96
	Kms x 1,000	1.5	10	20	30	40	50	60	70	80
MAINTENANCE ITEM										
<b>VEHICLE ON FLOOR</b>										
Wiper (wiper blade , washer fluid)	-	I	I	I	I	I	I	I	I	I
Brake/Clutch (Pedal free play/Pipes/Hoses/Connectors)	I	I	I	I	I	I	I	I	I	I
Fuel filler cap	I	I	I	I	I	I	I	I	I	I
Cabin air filter	I	C	R	C	R	C	R	C	R	R
Check AC system (refrigerant/ compressor)	I	I	I	I	I	I	I	I	I	I
Cooling system (water pump, hoses) & leakage	I	I	I	I	I	I	I	I	I	I
<b>VEHICLE ON LIFT</b>										
Steering gear rack, linkage and boots	I	I	I	I	I	I	I	I	I	I
Exhaust system	I	I	I	I	I	I	I	I	I	I
Fuel additives * <sup>7</sup>	-	Replace every 10,000 km (6,000 mi.) or 12 months								
Fuel filter * <sup>8</sup>	-	I	I	I	I	I	I	I	I	I
Fuel tank air filter	-	-	I	-	R	-	I	-	R	R
Front & rear suspension (linkages & ball joints)	-	I	I	I	I	I	I	I	I	I



I: Inspect and if necessary, adjust, correct, clean or replace.

C: Clean or replace (if necessary).

R: Replace or change.

TR: Tire Rotation.

L: Lubricate

MAINTENANCE INTERVAL	Number of months or driving distance, whichever comes first										
	Months	2	12	24	36	48	60	72	84	96	
	Kms x 1,000	1.5	10	20	30	40	50	60	70	80	
MAINTENANCE ITEM											
Tyre Pressure, condition & rotation	-	I,T R	I,T R	I,T R	I,T R	I,T R	I,T R	I,T R	I,T R	I,T R	
Fuel lines, hoses and connections	I	I	I	I	I	I	I	I	I	I	
Driveshafts & boots	I	I	I	I	I	I	I	I	I	I	
Fluid leakages	I	I	I	I	I	I	I	I	I	I	
Front and rear wheel bearings & bushes	I	I	I	I	I	I	I	I	I	I	
Parking brake (disc/drum, pad/shoe & operation)	-	C	C	C	C	C	C	C	C	C	
Wheel Alignment & Balancing	-	Inspect and if necessary, adjust									
<b>FINAL CHECKS</b>											
Bolt and nuts on chassis and body	I	I	I	I	I	I	I	I	I	I	
Lubricate locks & hinges	I	L	L	L	L	L	L	L	L	L	
Check all electrical systems (Drive belts, alternator) *9	I	I	I	I	I	I	I	I	I	I	
Warning lights operation & GDS system check	I	I	I	I	I	I	I	I	I	I	
Ext & int. lights, horn & gauges	I	I	I	I	I	I	I	I	I	I	

## Maintenance

---

I: Inspect and if necessary, adjust, correct, clean or replace.

C: Clean or replace (if necessary).

R: Replace or change.

MAINTENANCE INTERVAL	Number of months or driving distance, whichever comes first										
	Months	2	12	24	36	48	60	72	84	96	
	Kmsx 1,000	1.5	10	20	30	40	50	60	70	80	
MAINTENANCE ITEM											
Power window / Sunroof operation (if equipped)		I	C	C	C	C	C	C	C	C	C
All seat belt operation		I	I	I	I	I	I	I	I	I	I
Road test		-	-	-	I	-	-	I	-	-	-

## Maintenance under severe usage and low mileage conditions (Petrol engine)

The following items must be serviced more frequently on cars mainly used under severe and low mileage driving conditions. Refer to the chart below for the appropriate maintenance intervals.

I: Inspect and if necessary, adjust, correct, clean or replace

R: Replace

Maintenance item		Maintenance operation	Maintenance intervals	Driving condition
Engine oil and engine oil filter	Smartstream G1.5 MPI	R	Replace every 7,500 km (5,000 mi.) or 6 months	A, B, C, D, E, F, G, H, I, J, K, L
	Smartstream G1.5 T-GDi	R	Replace every 5,000 km (3,000 mi.) or 6 months	
Air cleaner filter		R	Replace more frequently depending on the condition	C, E
Spark plugs		R	Replace more frequently depending on the condition	A, B, F, G, H, I, K
Steering gear rack, linkage and boots		I	Inspect more frequently depending on the condition	C, D, E, F, G
Front suspension ball joints		I	Inspect more frequently depending on the condition	C, D, E, F, G
Disc brakes and pads, calipers and rotors		I	Inspect more frequently depending on the condition	C, D, E, G, H
Driveshaft and boots		I	Inspect more frequently depending on the condition	C, D, E, F, G, H, I, J
Cabin air filter		R	Replace more frequently depending on the condition	C, E, G
Automatic Transmission fluid		R	Every 100,000 km (62,000 mi.)	A, C, D, E, F, G, H, I, K, J
Intelligent Variable Transmission fluid		R	Every 90,000 km (60,000 mi.)	A, C, D, E, F, G, H, I, K, J

Maintenance item	Maintenance operation	Maintenance intervals	Driving condition
Dual Clutch Transmission fluid	R	Every 120,000 km (80,000 mi.)	C, D, F, G, H, I, J
Manual Transmission fluid	R	Every 120,000 km (80,000 mi.)	C, D, E, F, G, H, I, J

**Severe driving conditions**

- A. Repeatedly driving short distance of less than 8 km (5 mi.) in normal temperature or less than 16 km (10 mi.) in freezing temperature
- B. Extensive engine idling or low speed driving for long distances
- C. Driving on rough, dusty, muddy, unpaved, graveled or salt-spread roads
- D. Driving in areas using salt or other corrosive materials or in very cold weather
- E. Driving in the heavy dust conditions
- F. Driving in heavy traffic
- G. Driving on uphill, downhill, or mountain roads
- H. Using for towing or camping, and driving with loading on the roof
- I. Driving for patrol car, taxi, or other commercial use
- J. Frequently driving under high speed or rapid acceleration/deceleration
- K. Frequently driving in stop-and-go conditions
- L. Engine oil usage which is not recommended (Mineral type, Semi-synthetic, Lower grade spec, etc.)

## Normal maintenance schedule (Diesel Engine)

I: Inspect and if necessary, adjust, correct, clean or replace.

C: Clean or replace (if necessary).

R: Replace or change.

MAINTENANCE INTERVAL	Number of months or driving distance, whichever comes first										
	Months	2	12	24	36	48	60	72	84	96	
	Kms x 1,000	1.5	10	20	30	40	50	60	70	80	
MAINTENANCE ITEM											
<b>ENGINE BAY</b>											
Engine oil & filter *1 *2 *3 *4	I	R	R	R	R	R	R	R	R	R	
Drive belt	-	-	-	I	-	-	I	-	-		
Air cleaner filter	-	C	R	C	R	C	R	C	R		
Battery condition & specific gravity	I	I	I	I	I	I	I	I	I		
Hoses (Vaccum/ EGR / VGT/ WGT)	-	-	-	I	-	-	I	-	-		
Idler/ damper pulley/ Adj. Bolt	Inspect when replacing the drive belt or timing belt/chain										
Brake/Clutch fluid	I	I	R	I	I	R	I	I	I		
Engine Coolant (topup & specify gravity)*5	Inspect at every service; Replace first at 1,00,000 Km or 60 months; then at every 40,000 Km or 24 months										
Manual /Automatic /IVT /DCT fluid (if equipped) *6	No check, No service required										

## Maintenance

I: Inspect and if necessary, adjust, correct, clean or replace.

C: Clean or replace (if necessary).

R: Replace or change.

MAINTENANCE INTERVAL	Number of months or driving distance, whichever comes first									
	Months	2	12	24	36	48	60	72	84	96
	Kms x 1,000	1.5	10	20	30	40	50	60	70	80
MAINTENANCE ITEM										
<b>VEHICLE ON FLOOR</b>										
Wiper (wiper blade , washer fluid)	-	I	I	I	I	I	I	I	I	I
Brake/Clutch (Pedal free play/Pipes/Hoses/Connectors)	I	I	I	I	I	I	I	I	I	I
Fuel filler cap	I	I	I	I	I	I	I	I	I	I
Cabin air filter	I	C	R	C	R	C	R	C	R	R
Check AC system (refrigerant/ compressor)	I	I	I	I	I	I	I	I	I	I
Cooling system (water pump, hoses) & leakage	I	I	I	I	I	I	I	I	I	I
<b>VEHICLE ON LIFT</b>										
Steering gear rack, linkage and boots	I	I	I	I	I	I	I	I	I	I
Exhaust system	I	I	I	I	I	I	I	I	I	I
Fuel filter *8	-	I	R	I	R	I	R	I	R	R
Urea solution lines, hoses and connections	I	I	I	I	I	I	I	I	I	I
Urea solution tank cap	I	I	I	I	I	I	I	I	I	I
Front & rear suspension (linkages & ball joints)	-	I	I	I	I	I	I	I	I	I

I: Inspect and if necessary, adjust, correct, clean or replace.

C: Clean or replace (if necessary).

R: Replace or change.

TR: Tire Rotation.

L: Lubricate

MAINTENANCE INTERVAL	Number of months or driving distance, whichever comes first										
	Months	2	12	24	36	48	60	72	84	96	
	Kms x 1,000	1.5	10	20	30	40	50	60	70	80	
MAINTENANCE ITEM											
Tyre Pressure, condition & rotation		-	I,T R	I,T R	I,T R	I,T R	I,T R	I,T R	I,T R	I,T R	
Fuel lines, hoses and connections		I	I	I	I	I	I	I	I	I	
Driveshafts & boots		I	I	I	I	I	I	I	I	I	
Fluid leakages		I	I	I	I	I	I	I	I	I	
Front and rear wheel bearings & bushes		I	I	I	I	I	I	I	I	I	
Parking brake (disc/drum, pad/shoe & operation)		-	C	C	C	C	C	C	C	C	
Wheel Alignment & Balancing		-	Inspect and if necessary, adjust								
<b>FINAL CHECKS</b>											
Bolt and nuts on chassis and body		I	I	I	I	I	I	I	I	I	
Lubricate locks & hinges		I	L	L	L	L	L	L	L	L	
Check all electrical systems (Drive belts, alternator) *9		I	I	I	I	I	I	I	I	I	
Warning lights operation & GDS system check		I	I	I	I	I	I	I	I	I	
Ext & int. lights, horn & gauges		I	I	I	I	I	I	I	I	I	

## Maintenance

---

I: Inspect and if necessary, adjust, correct, clean or replace.

C: Clean or replace (if necessary).

R: Replace or change.

MAINTENANCE INTERVAL	Number of months or driving distance, whichever comes first										
	Months	2	12	24	36	48	60	72	84	96	
	Kms x 1,000	1.5	10	20	30	40	50	60	70	80	
MAINTENANCE ITEM											
Power window / Sunroof operation (if equipped)		I	C	C	C	C	C	C	C	C	C
All seat belt operation		I	I	I	I	I	I	I	I	I	I
Road test		-	-	-	I	-	-	I	-	-	-



## Maintenance under severe usage and low mileage conditions (Diesel engine)

The following items must be serviced more frequently on cars mainly used under severe and low mileage driving conditions. Refer to the chart below for the appropriate maintenance intervals.

I: Inspect and if necessary, adjust, correct, clean or replace

R: Replace

Maintenance item	Maintenance operation	Maintenance intervals	Driving condition
Engine oil and engine oil filter	R	Every 5,000 km (3,000 mi.) or 6 months	A, B, C, D, E, F, G, H, I, J, K, L
Air cleaner filter	R	Replace more frequently depending on the condition	C, E
Steering gear rack, linkage and boots	I	Inspect more frequently depending on the condition	C, D, E, F, G
Front suspension ball joints	I	Inspect more frequently depending on the condition	C, D, E, F, G
Disc brakes and pads, calipers and rotors	I	Inspect more frequently depending on the condition	C, D, E, G, H
Driveshaft and boots	I	Inspect more frequently depending on the condition	C, D, E, F, G, H, I, J
Cabin air filter	R	Replace more frequently depending on the condition	C, E, G
Automatic Transmission fluid	R	Every 100,000 km (62,000 mi.)	A, C, D, E, F, G, H, I, J, K
Manual Transmission fluid	R	Every 120,000 km (80,000 mi.)	C, D, E, F, G, H, I, J

**Severe driving conditions**

- A. Repeatedly driving short distance of less than 8 km (5 mi.) in normal temperature or less than 16 km (10 mi.) in freezing temperature
- B. Extensive engine idling or low speed driving for long distances
- C. Driving on rough, dusty, muddy, unpaved, graveled or salt-spread roads
- D. Driving in areas using salt or other corrosive materials or in very cold weather
- E. Driving in the heavy dust conditions
- F. Driving in heavy traffic
- G. Driving on uphill, downhill, or mountain roads
- H. Using for towing or camping, and driving with loading on the roof
- I. Driving for patrol car, taxi, or other commercial use
- J. Frequently driving under high speed or rapid acceleration/deceleration
- K. Frequently driving in stop-and-go conditions
- L. Engine oil usage which is not recommended (Mineral type, Semi-synthetic, Lower grade spec, etc.)

## Explanation of scheduled maintenance items

### Engine oil and filter

The engine oil and filter should be changed at the intervals specified in the Maintenance schedule (refer to the Service Passport in your vehicle). If the vehicle is being driven in severe conditions, more frequent oil and filter changes are required.

### Drive belts

Inspect all drive belts for evidence of cuts, cracks, excessive wear or oil saturation. Replace them if necessary.

Check the drive belts periodically for proper tension and adjusted as necessary.

#### **i** Information

Always turn off the engine before inspecting the drive belts.

### Fuel lines, fuel hoses and connections

Check the fuel lines, fuel hoses and connections for leakage and damage. We recommend that you have the any damaged or leaking parts replaced by a HYUNDAI authorised repairer immediately.

#### **⚠** WARNING

Diesel engine

Never manipulate or modify the injection system while running the diesel engine or within 30 seconds after turning OFF the diesel engine. The high-pressure pump, high-pressure pipes, rail, and injectors are still subject to high pressure immediately after stopping the diesel engine.

When the fuel leakage vents out, it may cause serious body injury. Any people, who are implanted with the artificial cardiac pacemaker, should remain away from the ECU or the wiring harness by at least 30 cm, while running the diesel engine. The high currents of the electronic engine control system produce a considerable amount of magnetic fields.

### Fuel Filter

The fuel filter is considered to be maintenance free but periodic inspection is recommended depending on the fuel quality. If there is fuel flow restriction, surging, loss of power, or hard starting, we recommend that you contact a HYUNDAI authorised repairer to have the fuel filter replaced immediately.

### Vapour hose and fuel filler cap

The vapour hose and fuel filler cap should be inspected at those intervals specified in the Maintenance schedule. Make sure a new vapour hose or fuel filler cap is correctly replaced.

### Vacuum crankcase ventilation hoses

Visually check for proper installation, chafing, cracks, deterioration, and any leakage. Replace any deteriorated or damaged parts immediately.

### Air cleaner filter

A genuine HYUNDAI air cleaner filter is recommended when the filter is replaced.

### Spark plugs

Be sure to install new spark plugs of the correct heat range.

When installing new spark plugs, make sure the ignition coils are clean and free of any oil or debris. Clean and wipe off the bottom portion of the ignition coil to prevent any contamination with the spark plug during installation.

#### **WARNING**

Do not remove spark plugs from the vehicle when the engine is hot. You may damage the engine and may also risk burn injury.

---

### Valve clearance

Inspect excessive valve noise and/or engine vibration and adjust if necessary.

We recommend that the system be serviced by a HYUNDAI authorised repairer.

### Cooling system

Check cooling system components, such as radiator, coolant reservoir, hoses and connections for leakage and damage. Replace any damaged parts.

### Engine coolant

The coolant should be changed at the intervals specified in the Maintenance schedule.

### Manual transmission fluid

 if equipped

Inspect the manual transmission fluid according to the Maintenance schedule.

### Automatic transmission fluid

 if equipped

Inspect the automatic transmission fluid according to the Maintenance schedule.

#### **Information**

A new automatic transmission fluid should be red. The red dye is added so the assembly plant can identify it as automatic transmission fluid and distinguish it from engine oil or anti-freeze. The red dye, which is not an indicator of fluid quality, is not permanent. As the vehicle is driven, the automatic transmission fluid will begin to look darker. The color may eventually appear light brown. Therefore, we recommend that the system be replaced by an authorised HYUNDAI dealer according to the scheduled maintenance at the beginning of this chapter.

Use only the specified automatic transmission fluid. (Refer to 'Recommended lubricants and capacities' in chapter 2.)

---

### Dual clutch transmission fluid

 if equipped

The dual clutch transmission fluid level does not need to be checked under normal usage conditions.

If driven in severe operating conditions, we recommend that the dual clutch transmission fluid be changed by a HYUNDAI authorised repairer according to the Maintenance schedule under severe conditions.

**NOTICE**

Only use the dual clutch transmission fluid specified in the “Recommended lubricants and capacities” section in chapter 2 to prevent transmission damage.

## Intelligent variable transmission fluid

 if equipped

Intelligent variable transmission fluid should not be checked under normal usage conditions.

We recommend that the intelligent variable transmission fluid is changed by an authorized HYUNDAI dealer according to the maintenance schedule.

### *i* Information

Intelligent variable transmission fluid color is light amber when new.

As the vehicle is driven, the intelligent variable transmission fluid will begin to look darker.

This is a normal condition. It does not need to be replaced based on the color change.

**NOTICE**

The use of a non-specified fluid could result in transmission malfunction and failure.

Use only specified intelligent variable transmission fluid.

## Brake hoses and lines

Visually check for proper installation, chafing, cracks, deterioration and any leakage. Replace any deteriorated or damaged parts immediately.

## Brake/clutch fluid

Check the brake/clutch fluid level in the brake fluid reservoir. The level should be between the MIN and the MAX marks on the side of the reservoir. Use only hydraulic brake fluid conforming to DOT 4 specification.

## Parking brake

Inspect the parking brake system including the cables.

## Brake discs, pads, calipers and rotors

Check the pads, the disc, and the rotor for any excessive wear-out. Inspect calipers for any fluid leakage.

For more information on checking the pads or lining wear limit, visit <http://service.hyundai-motor.com>

## Exhaust pipe and muffler

Visually inspect the exhaust pipes, muffler and hangers for cracks, deterioration, or damage. Start the engine and listen carefully for any exhaust gas leakage. Tighten connections or replace parts as necessary.

## Suspension mounting bolts

Check the suspension connections for looseness or damage. Retighten to the specified torque.

## Steering gear box, linkage & boots/lower arm ball joint

With the vehicle stopped and the engine off, check for excessive free-play in the steering wheel. Check the linkage for bends or damage. Check the dust boots and ball joints for deterioration, cracks, or damage.

Replace any damaged parts.

## Drive shafts and related

Check the drive shafts, boots and clamps for cracks, deterioration, or damage. Replace any damaged parts and, if necessary, repack the grease.

## Air conditioning refrigerant

Check the air conditioning lines and connections for leakage and damage.

## Engine oil

### Checking the engine oil level (Petrol engine)

Engine oil is used for lubricating, cooling, and operating various hydraulic components in the engine. Engine oil consumption whilst driving is normal, and it is necessary to check and refill the engine oil regularly. Also, check and refill the oil level within the recommended maintenance schedule to prevent deterioration of oil performance.

Check the engine oil following the below procedure.

1. Follow all of the oil manufacturer's precautions.
2. Make sure the vehicle is on the level ground in P (Park) with the parking brake applied.
3. Turn on the engine and warm the engine up until the coolant temperature reaches a constant normal temperature.
4. Turn off the engine, remove the oil filler cap and pull the dipstick out. Wait for 15 minutes for the oil to return to the oil pan.
5. Wipe the dipstick clean and re-insert it fully.
6. Pull the dipstick out again and check the level. The level should be between F (Full) and L (Low).

Smartstream G1.5 MPI

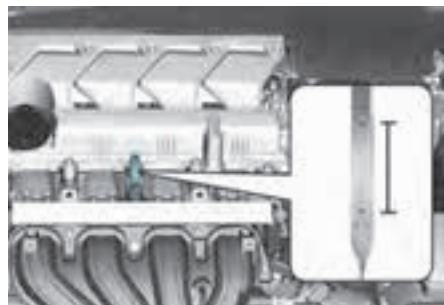

Smartstream G1.5 T-GDi

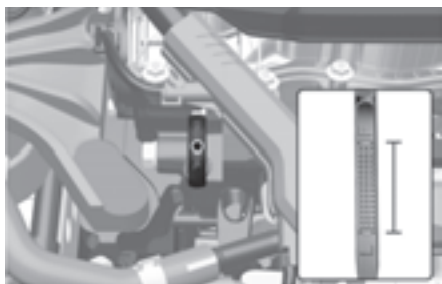

7. If the oil level is below L, add enough oil to bring the level to F.

Smartstream G1.5 MPI



Smartstream G1.5 T-GDi

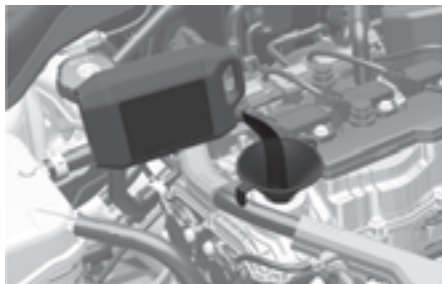

Use only the specified engine oil (Refer to the “Recommended lubricants and capacities” section in chapter 2).

### NOTICE

To prevent damage to your engine:

- Do not spill engine oil when adding or changing engine oil. Wipe off spilled oil immediately.
- The engine oil consumption may increase whilst you break in a new vehicle, and it should stabilize after driving 6,000 km (4,000 mi.).
- The engine oil consumption can be affected by driving habits, climate conditions, traffic conditions, oil quality, etc. Therefore, it is recommended that you inspect the engine oil level regularly and refill it if necessary.

## Checking the engine oil level (Diesel engine)

Range	Required action
A	Recommend to contact an authorized HYUNDAI dealer.
B	Do not refill engine oil.
C	Normal. You may add engine oil as long as the oil level does not go above the C range.
D	You must add oil and make sure that the oil level is in the C Range.

1. Follow all of the oil manufacturer's precautions.
2. Make sure the vehicle is on the level ground in P (Park) with the parking brake applied.
3. Turn on the engine and warm the engine up until the coolant temperature reaches a constant normal temperature.
4. Turn off the engine, remove the oil filler cap and pull the dipstick out. Wait for 15 minutes for the oil to return to the oil pan.
5. Wipe the dipstick clean and re-insert it fully.
6. Pull the dipstick out again and check the level. The level should be in C range.

Diesel 1.5 VGT

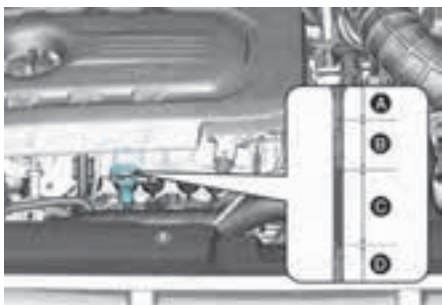

7. If the level is in the D range, add enough engine oil to bring the level up the range.

Diesel 1.5 VGT



Use only the specified engine oil (Refer to the "Recommended lubricants and capacities" section in chapter 2).

### NOTICE

To prevent damage to your engine:

- Do not spill engine oil when adding or changing engine oil. Wipe off spilled oil immediately.
- The engine oil consumption may increase whilst you break in a new vehicle, and it should stabilize after driving 6,000 km (4,000 mi.).
- The engine oil consumption can be affected by driving habits, climate conditions, traffic conditions, oil quality, etc. Therefore, it is recommended that you inspect the engine oil level regularly and refill it if necessary.



## Checking the engine oil and filter

### 2C\_RecommendedEngineOil

- The lubrication, rust prevention, cooling, and cleaning effect of the engine oil will gradually degrade during its use.

We recommend that the engine oil and filter be changed by a HYUNDAI authorised repairer according to the Maintenance schedule at the Service Passport in your vehicle.

- If the Maintenance schedule to replace engine oil is exceeded, the engine oil performance may deteriorate, and the engine condition may be affected. Therefore, replace the engine oil according to the Maintenance schedule.
- To keep the engine in optimal condition, use the recommended engine oil and filter. If the recommended engine oil and filter are not used, replace it according to the Maintenance schedule under severe usage conditions.
- The purpose of the Maintenance schedule for engine oil replacement is to prevent oil deterioration and it is irrelevant to oil consumption. Check and refill engine oil regularly.

## *i* Information

### Smartstream G1.5 T-GDI

When the oil pressure is low due to insufficient engine oil, the Engine Oil Pressure (🛢️) warning light illuminates. In addition, the enhanced engine protection system, which limits the engine's power is activated and the Malfunction Indicator Lamp (🚗) illuminates when the vehicle is driven in this state continuously. When oil pressure is restored, the Engine Oil Pressure warning light turns off and the engine power is no longer limited.

## CAUTION

The engine oil is very hot immediately after the vehicle has been driven and can cause burns during replacement. Replace the engine oil after the engine oil has cooled down.

Never add any additives to the engine oil. Engine oil additives can change the properties of engine oil and may cause serious engine failure.

## WARNING

Used engine oil may cause irritation or cancer of the skin if left in contact with the skin for prolonged periods of time. Used engine oil contains chemicals that have caused cancer in laboratory animals. Always protect your skin by washing your hands thoroughly with soap and warm water as soon as possible after handling used oil.

## Engine coolant

The high-pressure cooling system has a reservoir filled with year-round antifreeze coolant. The reservoir is filled at the factory.

Check the antifreeze protection and coolant level at least once a year, at the beginning of the winter season and before travelling to a colder climate.

### Checking the coolant level



Check the condition and connections of all cooling system hoses and heater hoses. Replace any swollen or deteriorated hoses.

The coolant level should be filled between F/MAX and L/MIN marks on the side of the coolant reservoir when the engine is cool.

If the coolant level is low, add enough distilled (deionized) water to bring the level to the F/MAX mark, but do not overfill. If frequent additions are required, we recommend that you see a HYUNDAI authorised repairer for a cooling system inspection.

### WARNING



Never remove the radiator cap or the drain plug whilst the engine and radiator are hot. Hot coolant and steam may blow out under pressure, causing serious injury.

Turn the engine off and wait until the engine cools down. Use extreme care when removing the radiator cap. Wrap a thick towel around it, and turn it counterclockwise slowly to the first stop. Step back whilst the pressure is released from the cooling system. When you are sure all the pressure has been released, press down on the cap, using a thick towel, and continue turning counterclockwise to remove it.

### Information

The coolant level is influenced by the engine temperature. Before checking or refilling the coolant, turn the engine off.

**⚠ WARNING**

The electric motor for the cooling fan may continue to operate or start up when the engine is not running and can cause serious injury. Keep hands, clothing and tools away from the rotating fan blades of the cooling fan.

Always turn off the vehicle unless the vehicle has to be inspected with the engine on. Be cautious as the cooling fan may operate if the negative (-) battery terminal is not disconnected.

**⚠ WARNING**

Make sure the coolant cap is properly closed after refilling coolant. Otherwise the engine could be overheated whilst driving.

1. Check if the coolant cap label is straight in front.



2. Make sure that the tiny protrusions inside the coolant cap is securely interlocked.

**Recommended coolant**

- When adding coolant, use only deionized water, distilled water or soft water for your vehicle and never mix hard water in the coolant filled at the factory.
- An incorrect coolant mixture can result in severe malfunction or engine damage.
- The engine in your vehicle has aluminium engine parts and must be protected by an phosphate-based ethylene glycol coolant to prevent corrosion and freezing.
- Do not use alcohol or methanol coolant or mix them with the specified coolant.
- Do not use a solution that contains more than 60 % antifreeze or less than 35 % antifreeze, which would reduce the effectiveness of the solution.

For mixing percentage, refer to the following table:

Ambient Temperature	Mixture Percentage (volume)	
	Antifreeze	Water
-15 °C (5 °F)	35	65
-25 °C (-13 °F)	40	60
-35 °C (-31 °F)	50	50
-45 °C (-49 °F)	60	40

### **i** Information

If in doubt about the mix ratio, a 50 % water and 50 % antifreeze mix is the easiest to mix together as it will be the same quantity of each. It is suitable to use for most temperature ranges of -35 °C (-31 °F) and higher.

---

### Changing coolant

We recommend that you have the coolant changed by a HYUNDAI authorised repairer according to the Maintenance schedule at the Service Passport in your vehicle.

### **!** WARNING

Do not use engine coolant or antifreeze in the washer fluid reservoir.

Engine coolant can severely obscure visibility when sprayed on the windscreen and may cause loss of vehicle control resulting in an accident.

Engine coolant may also cause damage to paint and body trim.

---

### **NOTICE**

To prevent damage to engine parts, put a thick towel around the engine coolant cap before refilling the coolant to prevent the coolant from overflowing into engine parts, such as the alternator.

---

## Brake/clutch fluid

### Checking the brake/clutch fluid level

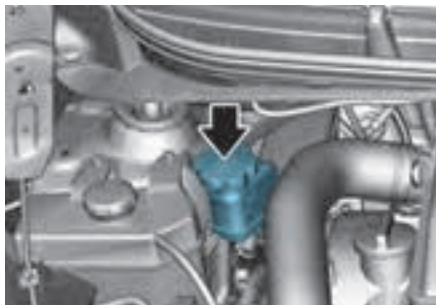

Check the fluid level in the reservoir periodically. The fluid level should be between MAX and MIN marks on the side of the reservoir.

Before removing the reservoir cap and adding brake/clutch fluid, clean the area around the reservoir cap thoroughly to prevent brake/clutch fluid contamination.

If the level is low, add fluid to the MAX level. The level will fall with accumulated mileage. This is a normal condition associated with the wear of the brake linings.

If the fluid level is excessively low, we recommend that your vehicle be inspected by a HYUNDAI authorised repairer.

### **!** WARNING

If the brake system requires frequent additions of fluid this could indicate a leak in the brake system. We recommend that the vehicle be inspected by a HYUNDAI authorised repairer.

---

**⚠ WARNING**

Do not let brake/clutch fluid into your eyes. If brake/clutch fluid gets in your eyes, flush your eyes with clean water for at least 15 minutes and get immediate medical attention.

**NOTICE**

- Do not allow brake/clutch fluid to contact the vehicle's body paint, as it will result in paint damage.
- NEVER use brake/clutch fluid which has been exposed to open air for an extended time, as its quality cannot be guaranteed.
- Do not use the wrong type of brake/clutch fluid. A few drops of mineral based oil, such as engine oil in your brake system can damage brake system parts.

***i* Information**

Use only the specified brake/clutch fluid (Refer to the "Recommended lubricants and capacities" section in chapter 2).

## Washer fluid

### Checking the washer fluid level

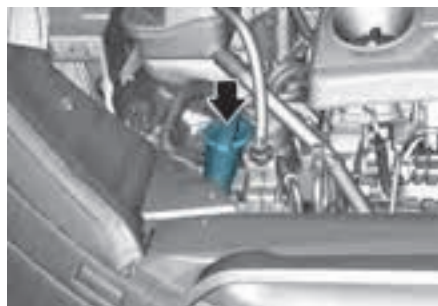

Check the fluid level in the washer fluid reservoir and add fluid if necessary. Plain water may be used if washer fluid is not available. However, use washer solvent with antifreeze characteristics in cold climates to prevent freezing.

**⚠ WARNING**

To prevent serious injury or death, take the following safety precautions when using washer fluid:

- Do not use engine coolant or antifreeze in the washer fluid reservoir. Engine coolant can severely obscure visibility when sprayed on the windscreen and may cause loss of vehicle control resulting in an accident or damage to paint and body trim.
- Do not allow sparks or flame to contact the washer fluid or the washer fluid reservoir. Washer fluid may contain alcohol and can be flammable.
- Do not drink washer fluid and avoid contact with skin. Washer fluid is harmful to humans and animals.
- Keep washer fluid away from children and animals.

## Parking brake

### Checking the parking brake



Check the stroke of the parking brake by counting the number of “clicks” heard whilst fully applying it from the released position. Also, the parking brake alone should securely hold the vehicle on a fairly steep grade. If the stroke is more or less than specified, we recommend that the system be serviced by a HYUNDAI authorised repairer.

**Stroke : 5~7 “clicks” at a force of 20 kg (44 lbs, 196 N).**

## Fuel filter (for diesel engine)

### Draining water from fuel filter

The fuel filter in the diesel engine separates water from fuel and prevents water from accumulating.

When water is accumulated inside the fuel filter, the fuel filter (⚠) warning light illuminates with the engine on.

If this occurs, we recommend that you have the system checked by a HYUNDAI authorised repairer.

#### **NOTICE**

When accumulated water is not drained at the proper timing, water may permeate in the fuel filter, damaging the major vehicle components, such as the fuel system.

### Fuel filter cartridge replacement

We recommend the fuel filter cartridge be replaced by a HYUNDAI authorised repairer according to the maintenance schedule at the beginning of this chapter.

## Air cleaner

### Filter replacement

The air cleaner filter can be cleaned for inspection using compressed air.

Do not attempt to wash or to rinse it, as water will damage the filter.

If soiled, the air cleaner filter must be replaced.

Replace the filter according to the Maintenance schedule.

1. Loosen the hose clamp and remove hose from cleaner.



2. Open the cleaner cover by opening the clips.



3. Remove the used filter and wipe the inside of the air cleaner housing carefully not to remain dusts in cover housing.

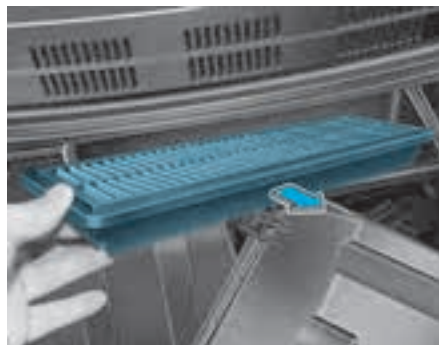

4. Place the new filter with clean hands and ensure the rubber gasket is not taken off.
5. Reassemble in the reverse order of removal.

### *i* Information

If the vehicle is operated in extremely dusty or sandy areas, replace the air cleaner filter more often than the usual recommended intervals. (Refer to “9-15” in this chapter.)

### NOTICE

- Do not drive with the air cleaner filter removed. This will result in excessive engine wear.
- When removing the air cleaner filter, be careful that dust or dirt does not enter the air intake, or damage may result.
- We recommend that you use parts for replacement from a HYUNDAI authorised repairer. Use of non-genuine parts could damage the engine.
- Do not blow the inner part of the air filter with compressed air. Dust or dirt may enter the air intake.
- Check that the replaced filter is firmly fixed when reassembling the air cleaner filter, and that the levers are firmly assembled.

## Cabin air filter

### Filter inspection

The cabin air filter should be replaced according to the Maintenance schedule. If the vehicle is operated in severely air-polluted cities or on dusty rough roads for a long period, it should be inspected more frequently and replaced sooner. Replace the cabin air filter by following the procedure below and be careful to avoid damaging other components.

### Filter replacement

1. Open the glove box and remove the support rod (1).



2. Push in both sides of the glove box as shown. This will ensure that the glove box stopper pins will get released from its holding location allowing the glove box to hang.





- Remove the climate control air filter cover.

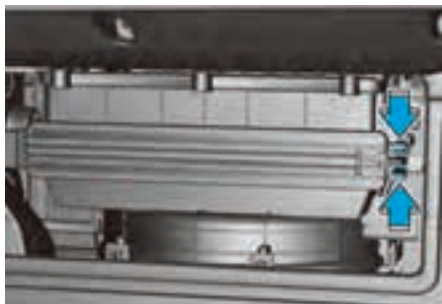

- Replace the cabin air filter.
- Reassemble in the reverse order of disassembly.

#### NOTICE



Install a new cabin air filter in the correct direction with the arrow symbol (↓) facing downwards, to prevent noise and reduce effectiveness.

## Wiper blades

### Blade inspection

Contamination of the windscreen or wiper blades with foreign substances may reduce the effectiveness of the windscreen wipers.

Common sources of contamination are insects, tree sap, and hot wax treatments used by some commercial car washes. If the blades are not wiping properly, clean both the window and the blades with glass cleaner or mild detergent, and rinse thoroughly with clean water. Replace blades as needed.

#### NOTICE

To prevent damage to the wiper blades, arms, or other components, do not:

- Use petrol, kerosene, paint thinner, or other solvents on or near them.
- Attempt to move the wipers manually.

### Blade replacement

When the wipers no longer clean adequately, the blades may be worn or cracked. Replace the wipers with new ones.

#### NOTICE

To prevent damage:

- Never use non-specified wiper blades.
- Lift the wiper arms when in the top wiping position.
- Always return the wiper arms to the windscreen before driving.

### **Front windscreen wiper blade replacement**

1. Raise the wiper arm and turn the wiper blade assembly to expose the plastic locking clip.



2. Compress the clip and slide the blade assembly downward.



3. Lift it off the arm.
4. Install the blade assembly in the reverse order of removal.

#### **NOTICE**

- Avoid the wipers from touching the windscreen when the wiper blade is disassembled to prevent windscreen damage.
- The wiper may not operate for about 10 seconds if the wiper is operated without washer fluid or the blades are frozen to prevent damage to the motor.

## Rear window wiper blade replacement

 If equipped



1. Raise the wiper arm and then rotate the wiper blade assembly (1).
2. Pull out the wiper blade assembly (2).
3. Install the new blade assembly by inserting the centre part into the slot in the wiper arm until it clicks into place (3).



4. If the replacement is complete, put down the wiper arm onto the rear windscreen, and turn the vehicle ON and operate the wipers to check the blade is installed correctly.

## Battery

### WARNING

To prevent **SERIOUS INJURY** or **DEATH** to you or bystanders, always follow these precautions when working near or handling the battery:



Always read and follow instructions carefully when handling a battery.



Wear eye protection designed to protect the eyes from acid splashes.



Keep all flames, sparks, or smoking materials away from the battery.



Hydrogen is always present in battery cells, is highly combustible, and may explode if ignited.



Keep batteries out of reach of children.



Batteries contain sulfuric acid which is highly corrosive. Do not allow acid to contact your eyes, skin or clothing.

If acid gets into your eyes, flush your eyes with clean water for at least 15 minutes and get immediate medical attention. If acid gets on your skin, thoroughly wash the area. If you feel pain or a burning sensation, get medical attention immediately.



The battery contains lead. Do not dispose of it after use. Please return the battery to an authorised HYUNDAI dealer to be recycled.

- When lifting a plastic-cased battery, excessive pressure on the case may cause battery acid to leak. Lift with a battery carrier or with your hands on opposite corners.
- Do not attempt to jump start your vehicle if your battery is frozen.
- NEVER attempt to recharge the battery when the vehicle's battery cables are connected to the battery.

- The electrical ignition system works with high voltage. NEVER touch these components with the engine running or when the Engine Start/Stop button is in the ON position.

---

### NOTICE

Always follow these instructions when handling your vehicle's battery to prevent damage to your battery:

- When you do not use the vehicle for a long time in a low temperature area, disconnect the battery and keep it indoors.
  - Always charge the battery fully to prevent battery case damage in low temperature areas.
  - Prevent liquid from wetting the battery terminals. The performance of the battery may be degraded, and may cause injury. Be cautious when loading liquid in the tailgate.
  - Do not tilt the battery.
  - If you connect unauthorised electronic devices to the battery, the battery may be discharged. Never use unauthorised devices.
-

## For best battery service

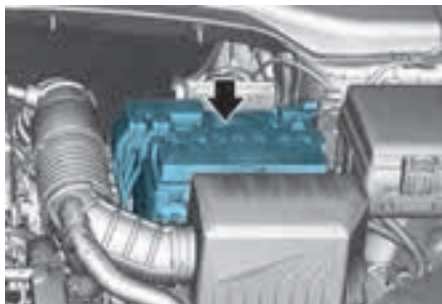

- Keep the battery securely mounted.
- Keep the battery top clean and dry.
- Keep the terminals and connections clean, tight, and coated with petroleum jelly or terminal grease.
- Rinse any spilled acid from the battery immediately with a solution of water and baking soda.
- If the vehicle is not going to be used for an extended time, disconnect the battery cables.

## *i* Information

For batteries marked with UPPER and LOWER



If your vehicle is equipped with a battery marked with LOWER (MIN) and UPPER (MAX) on the side, you should check the electrolyte level.

The electrolyte level should be between LOWER (MIN) and UPPER (MAX).

Be careful not to spill distilled (or de-mineralized) water over the battery surface or other adjacent components.

Also, do not overfill the battery cells. If not, it may corrode the battery or other components. Finally, securely close the cell cap. However, we recommend you to contact an authorized HYUNDAI dealer for better battery service.

## **NOTICE**

If the Electrolyte level is Low, add distilled (or demineralized) water. Never add sulfuric acid or other electrolyte.

## Battery capacity label



- The actual battery label in the vehicle may differ from the illustration.
1. CMF45L-DIN: The HYUNDAI model name of battery
  2. 12V: The nominal voltage
  3. 45Ah (20HR): The nominal capacity (in Ampere hours)
  4. RC 80min: The nominal reserve capacity (in min.)
  5. CCA410 (SAE/EN): The cold-test current in amperes by SAE
  6. 410A: The cold-test current in amperes by EN

## Battery recharging

### ***By battery charger***

Your vehicle has a maintenance free, calcium based battery.

- If the battery becomes discharged in a short time (because, for example, the headlights or interior lights were left on whilst the vehicle was not in use), recharge it by slow charging (trickle) for 10 hours.
- If the battery gradually discharges because of high electric load whilst the vehicle is being used, recharge it at 20-30 A for two hours.

### **⚠ WARNING**

Always follow these instructions when recharging your vehicle's battery to avoid the risk of **SERIOUS INJURY** or **DEATH** from explosions or acid burns:

- Before performing maintenance or recharging the battery, turn off all accessories and press the Engine Start/Stop button to the OFF position.
- Keep all flames, sparks, or smoking materials away from the battery.
- Always work outdoors or in an area with plenty of ventilation.
- Wear eye protection when checking the battery during charging.
- The battery must be removed from the vehicle and placed in a well ventilated area.

- Watch the battery during charging, and stop or reduce the charging rate if the battery cells begin boiling violently.
- The negative battery cable must be removed first and installed last when the battery is disconnected. Disconnect the battery charger in the following order:
  1. Turn off the battery charger main switch.
  2. Unhook the negative clamp from the negative battery terminal.
  3. Unhook the positive clamp from the positive battery terminal.
- We recommend that you use a genuine HYUNDAI approved battery or the equivalent specified for your vehicle when you replace the battery.

### NOTICE

#### AGM battery (if equipped)

- Absorbent Glass Matt (AGM) batteries are maintenance-free and we recommend that the AGM battery be serviced by a HYUNDAI authorised repairer. For charging your AGM battery, use only fully automatic battery chargers that are specially developed for AGM batteries.
- When replacing the AGM battery, we recommend that you use parts for replacement from a HYUNDAI authorised repairer.
- Do not open or remove the cap on top of the battery. This may cause leaks of internal electrolyte that could result in severe injury.

### By jump starting

After a jump start from a good battery, drive the vehicle for 20-30 minutes before it is shutoff. The vehicle may not restart if you shut it off before the battery had a chance to adequately recharge. See “Jump starting” in chapter 8 for more information on jump starting procedures.

### *i* Information



An inappropriately disposed battery can be harmful to the environment and human health. Dispose of the battery according to your local law(s) or regulation.

### Reset items

The following items may need to be reset after the battery has been discharged or the battery has been removed:

- Driving info/Since refuelling/Accumulated info (refer to chapter 4)
- Power window (refer to chapter 5)
- Sunroof (refer to chapter 5)
- Climate control system (refer to chapter 5)
- Clock (refer to Infotainment system manual)
- Infotainment system (refer to Infotainment system manual)

## Tyres and wheels

### WARNING

Tyre failure may cause loss of vehicle control and result in a collision. To reduce risk of serious injury or death:

- Inspect your tyres monthly for proper inflation as well as wear and damage.
  - The recommended cold tyre pressure for your vehicle can be found in this manual and on the tyre label located on the driver's side centre pillar. Always use a tyre pressure gauge to measure tyre pressure. Tyres with too much or too little pressure wear unevenly causing poor handling.
  - Check the pressure of the spare every time you check the pressure of the other tyres on your vehicle.
  - Replace tyres that are worn, show uneven wear, or are damaged. Worn tyres can cause loss of braking effectiveness, steering control, or traction.
  - Always replace tyres with the same size, type, construction, and tread pattern as each tyre that was originally supplied with this vehicle. Using tyres and wheels other than the recommended sizes may cause unusual handling characteristics, poor vehicle control, or negatively affect your vehicle's Anti-Lock Brake System (ABS) resulting in a serious accident.
- 

## Tyre care

For proper maintenance, safety, and maximum fuel economy, always maintain recommended tyre inflation pressures and stay within the load limits and weight distribution recommended for your vehicle.



All specifications (sizes and pressures) can be found on a label attached to the driver's side centre pillar.

### Recommended cold tyre inflation pressures

Check all tyre pressures (including the spare) when the tyres are cold. "Cold tyres" mean the vehicle has not been driven for at least three hours or driven less than 1.6 km (1 mi.).

Warm tyres normally exceed the recommended cold tyre pressures by 28 to 41 kPa (4 to 6 psi). Do not release air from warm tyres to adjust the pressure. The tyres are under-inflated. For recommended inflation pressure, refer to the "Tyres and wheels" section in chapter 2.



**⚠ WARNING**

- Recommended pressures must be maintained for the best ride, vehicle handling, and minimum tyre wear.
- Over-inflation or under-inflation can reduce tyre life, adversely affect vehicle handling, and lead to sudden tyre failure that may result in loss of vehicle control resulting in a collision.
- Severe under-inflation may lead to severe heat build-up, causing blowouts, tread separation, and other tyre failures that may result in loss of vehicle control resulting in a collision. This risk is much higher on hot days and when driving for a long time at high speeds.
- Under-inflation may cause excessive wear, poor handling, and reduced fuel economy. Wheel deformation is also possible. Keep your tyre pressures at the proper levels. If a tyre frequently needs refilling, we recommend that your vehicle be inspected by a HYUNDAI authorised repairer.
- Over-inflation produces a harsh ride, excessive wear at the centre of the tyre tread, and a greater possibility of damage from road hazards.

**Check tyre inflation pressure**

Check your tyres, including the spare tyre(if equipped), at least once a month.

***How to check***

Use a good quality tyre pressure gauge to check the tyre pressure. You cannot tell if your tyres are properly inflated simply by looking at them. Radial tyres may look properly inflated when they are underinflated.

Remove the valve cap from the tyre valve stem. Press the tyre gauge firmly onto the valve to get a pressure measurement. If the cold tyre inflation pressure matches the recommended pressure on the tyre and loading information label, no further adjustment is necessary. If the pressure is low, add air until it reaches the recommended pressure.

Be sure to put the valve caps back on the valve stems. Without the valve cap, dirt or moisture may get into the valve core and cause air leakage. If a valve cap is missing, install a new one as soon as possible.

If you overfill the tyre, release air by pushing on the metal stem in the centre of the tyre valve. Recheck the tyre pressure with the tyre gauge. Be sure to put the valve caps back on the valve stems. Without the valve cap, dirt or moisture may get into the valve core and cause air leakage. If a valve cap is missing, install a new one as soon as possible.

## Tyre rotation

To equalize tread wear, HYUNDAI recommends that the tyres be rotated according to the Maintenance schedule or sooner if irregular wear develops.

During rotation, check the tyres for correct balance.

When rotating tyres, check for uneven wear and damage. Abnormal wear is usually caused by incorrect tyre pressure, improper wheel alignment, out-of-balance wheels, severe braking, or severe cornering. Look for bumps or bulges in the tread or side of the tyre. Replace the tyre if you find any of these conditions. Replace the tyre if fabric or cord is visible. After rotation, be sure to bring the front and rear tyre pressures to specification and check nut torque (proper torque is 79-94 lbf-ft (11-13 kgf·m)).

With a full-size spare tyre (if equipped)

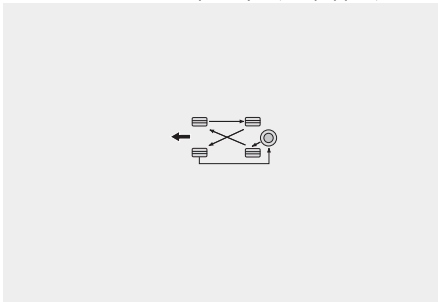

Without a spare tyre

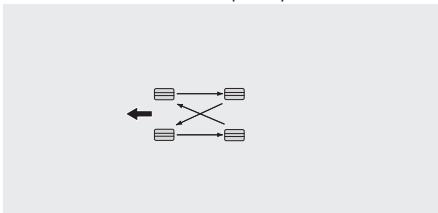

Directional tyres (if equipped)

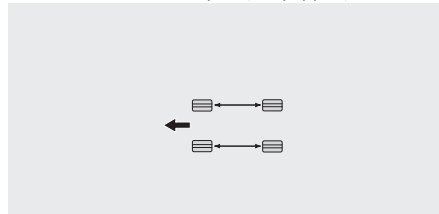

Disc brake pads should be inspected for wear whenever tyres are rotated.

### **i** Information

When installing an unsymmetrical tyre, install the side marked “outside” facing out.

### **!** WARNING

- Do not use the compact spare tyre for tyre rotation.
- Do not mix bias ply and radial ply tyres under any circumstances. This may cause unusual handling characteristics that may cause loss of vehicle control and result in a collision.

## Wheel alignment and tyre balance

The wheels on your vehicle were aligned and balanced carefully at the factory, and you may not need to have your wheels aligned again. If you notice unusual tyre wear or your vehicle pulling to one side, the alignment may need to be adjusted.

If you notice your vehicle vibrating when driving on a smooth road, your wheels may need to be rebalanced.

### **NOTICE**

Only use approved wheel weights or your vehicle’s aluminium wheels may be damaged.

## Tyre replacement



[A] Tread wear indicator

If the tyre is worn evenly, a tread wear indicator appears as a solid band across the tread. This shows there is less than 1/16 inches (1.6 mm) of tread left on the tyre. Replace the tyre when this happens.

Do not wait for the band to appear across the entire tread before replacing the tyre.

### NOTICE

When replacing the tyres, recheck and tighten the wheel nuts after driving about 1,000 km (620 miles). If the steering wheel shakes or the vehicle vibrates while driving, the tyre is out of balance. Align the tyre balance. If the problem is not solved, we recommend that you contact an authorised HYUNDAI dealer.

### ⚠ WARNING

To reduce the risk of death or serious injury:

- Replace tyres that are worn, show uneven wear, or are damaged. Worn tyres may cause loss of braking effectiveness, steering control, and traction.
- Always replace tyres with the same size as each tyre that was originally supplied with this vehicle. Using tyres and wheels other than the recommended sizes may cause unusual handling characteristics, poor vehicle control, or negatively affect your vehicle's Anti-Lock Brake System (ABS).
- When replacing tyres (or wheels), it is recommended to replace the two front or two rear tyres (or wheels) as a pair. Replacing just one tyre may seriously affect your vehicle's handling.
- Tyres degrade over time, even when they are not being used. Regardless of the remaining tread, HYUNDAI recommends that tyres be replaced after 6 years of normal service.
- Driving in hot climates or excessive loading may accelerate the tyre aging process.

### Compact spare tyre replacement

**+** if equipped

A compact spare tyre has a shorter tread life than a regular size tyre. Replace it when you can see the tread wear indicator bars on the tyre. The replacement compact spare tyre should be the same size and design tyre as the one provided with your vehicle and must be mounted on the same compact spare tyre wheel. The compact spare tyre is not designed to be mounted on a regular size wheel, and the compact spare tyre wheel is not designed for mounting a regular size tyre.

**⚠ WARNING**

The normal size tyre should be repaired or replaced as soon as possible to avoid failure of the spare and loss of vehicle control resulting in a collision.

The compact spare tyre is for emergency use only. Do not operate your vehicle over 80 km/h (50 mph) when using the compact spare tyre.

---

### Wheel replacement

When replacing the metal wheels for any reason, make sure the new wheels are equivalent to the original factory units in diameter, rim width, and offset.

**⚠ WARNING**

A wheel that is not the correct size may adversely affect wheel and bearing life, braking and stopping abilities, handling characteristics, ground clearance, body-to-tyre clearance, snow chain clearance, speedometer and odometer calibration, headlight aim and bumper height.

---

### Tyre traction

Tyre traction can be reduced if you drive on worn tyres or the tyres that are improperly inflated, or on slippery road surfaces. Replace the tyres when tread wear indicators appear. To reduce the possibility of losing control, slow down whenever there is rain, snow, or ice on the road.

### Tyre maintenance

In addition to proper inflation, correct wheel alignment helps decrease the tyre wear. If you find a tyre is worn unevenly, have your dealer check the wheel alignment. When you have new tyres installed, make sure they are balanced. This may increase ride comfort and tyre life. Additionally, a tyre must always be rebalanced if it is removed from the wheel.

### Tyre sidewall labelling

This information identifies and describes the fundamental characteristics of the tyre and also provides the tyre identification number (TIN) for safety standard certification. The TIN can be used to identify the tyre in case of a recall.

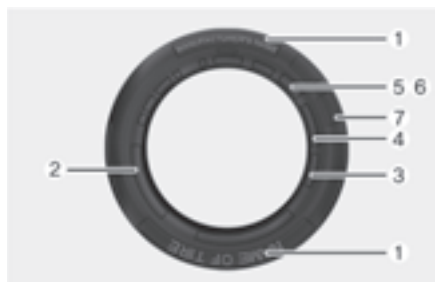

#### 1. **Manufacturer or brand name**

Manufacturer or brand name is shown.

#### 2. **Tyre size designation**

A tyre's sidewall is marked with a tyre size designation. You need this information when selecting replacement tyres for your vehicle. The following explains what the letters and numbers in the tyre size designation mean.

Example tyre size designation:

(These numbers are provided as an example only. Your tyre size designator may vary depending on your vehicle.)

**215/60 R17 96H**

215: Tyre width in millimeters.

60: Aspect ratio. The tyre's section height as a percentage of its width.

R: Tyre construction code (Radial).

17: Rim diameter in inches.

96: Load Index, a numerical code associated with the maximum load the tyre can carry.

H: Speed Rating Symbol. See the speed rating chart in this section for additional information.

**Wheel size designation**

Wheels are also marked with important information that you need if you ever have to replace one.

Example wheel size designation:

**6.0J X 17**

6.0: Rim width in inches.

J: Rim contour designation.

17: Rim diameter in inches.

**Tyre speed ratings**

The chart below lists many of the different speed ratings currently being used for passenger vehicle tyres. The speed rating is part of the tyre size designation on the sidewall of the tyre. This symbol corresponds to that tyre's designed maximum safe operating speed.

Speed Rating Symbol	Maximum Speed
S	180 km/h (112 mph)
T	190 km/h (118 mph)
H	210 km/h (130 mph)
V	240 km/h (149 mph)
W	270 km/h (168 mph)
Y	300 km/h (186 mph)

**3. Checking tyre life (TIN: Tyre Identification Number)**

Any tyres that are over six years old, based on the manufacturing date, (including the spare tyre) must be replaced by new ones. You can find the manufacturing date on the tyre sidewall (possibly on the inside of the wheel), displaying the DOT Code. The DOT Code is a series of numbers on a tyre consisting of numbers and English letters. The manufacturing date is designated by the last four digits (characters) of the DOT code.

**DOT: XXXX XXXX OOOO**

The front part of the DOT shows a plant code number, tyre size and tread pattern and the last four numbers indicate week and year manufactured.

For example:

DOT XXXX XXXX 1523 represents that the tyre was produced in the 15th week of 2023.

**i Information****Tyre age**

Tyres degrade over time, even when they are not being used.

Regardless of the remaining tread, it is recommended that tyres generally be replaced after six (6) years of normal service. Heat caused by hot climates or frequent high loading conditions can accelerate the aging process. Failure to follow this warning could cause sudden tyre failure, which could lead to a loss of control and an accident involving serious injury or death.

#### **4. Tyre ply composition and material**

The number of layers or plies of rubber-coated fabric in the tyre. Tyre manufacturers also must indicate the materials in the tyre, which include steel, nylon, polyester, and others. The letter “R” means radial ply construction. The letter “D” means diagonal or bias ply construction; and the letter “B” means belted-bias ply construction.

#### **5. Maximum permissible inflation pressure**

This number is the greatest amount of air pressure that should be put in the tyre. Do not exceed the maximum permissible inflation pressure. Refer to the Tyre and Loading Information label for recommended inflation pressure.

#### **6. Maximum load rating**

This number indicates the maximum load in kilograms and pounds that can be carried by the tyre. When replacing the tyres on the vehicle, always use a tyre that has the same load rating as the factory installed tyre.

#### **7. Uniform tyre quality grading**

Quality grades can be found where applicable on the tyre sidewall between tread shoulder and maximum section width.

For example:  
TREADWEAR 200  
TRACTION AA  
TEMPERATURE A

#### **Tread wear**

The tread wear grade is a comparative rating based on the wear rate of the tyre when tested under controlled conditions on a specified government test course. For example, a tyre graded 150 would wear one-and-a-half times (1½) as well on the government course as a tyre graded 100.

The relative performance of tyres depends upon the actual conditions of their use, however, and may depart significantly from the norm due to variations in driving habits, service practices, and differences in road characteristics and climate.

These grades are molded on the sidewalls of passenger vehicle tyres. The tyres available as standard or optional equipment on your vehicle may vary depending on the grade.

#### **Traction - AA, A, B & C**

The traction grades, from highest to lowest, are AA, A, B, and C. Those grades represent the tyre’s ability to stop on wet pavement as measured under controlled conditions on specified government test surfaces of asphalt and concrete. A tyre marked C may have poor traction performance.

#### **WARNING**

The traction grade assigned to this tyre is based on straight ahead braking traction tests, and does not include acceleration, cornering, hydroplaning, or peak traction characteristics.

---

### Temperature - A, B & C

The temperature grades are A (the highest), B and C representing the tyre's resistance to the generation of heat and its ability to dissipate heat when tested under controlled conditions on a specified indoor laboratory test wheel.

Sustained high temperature may cause the material of the tyre to degenerate and reduce tyre life, and excessive temperature may lead to sudden tyre failure. The grade C corresponds to a level of performance that all passenger car tyres must meet the Federal Motor Vehicle Safety Standard No. 109. Grades A and B represent higher levels of performance on the laboratory test wheel than the minimum required by law.

#### WARNING

The temperature grade for this tyre is established for a tyre that is properly inflated and not overloaded. Excessive speed, under-inflation, over-inflation, or excessive loading, either separately or in combination, may cause heat build-up and possible sudden tyre failure.

### Low aspect ratio tyres

 if equipped

The aspect ratio is lower than 50 on low aspect ratio tyres.

Because low aspect ratio tyres are optimized for handling and braking, their sidewall is a little stiffer than a standard tyre. Also low aspect ratio tyres tend to be wider and consequently have a greater contact patch with the road surface. In some instances they may generate more road noise compared with standard tyres.

#### CAUTION

Low aspect wheels and tyres are easily damaged. To reduce the risk of damage:

- When driving on rough roads, passing over a pothole, speed bump, manhole, or kerb stone, drive the vehicle slowly not to damage the tyres and wheels. Damage is not covered by your vehicle warranty.
- Inspect the tyre condition and pressure every 3,000 km (1,800 mi.).
- It is difficult to visually inspect for tyre damage with your eyes. If any damage is found, we recommend that you contact a HYUNDAI authorised repairer to replace the tyre.

## Fuses

Blade type



Cartridge type



Multi type

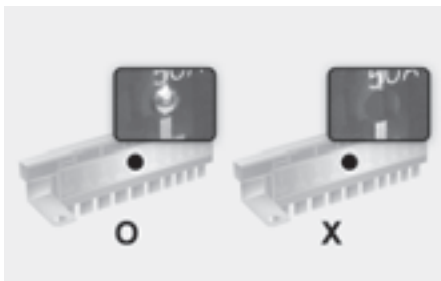

A vehicle's electrical system is protected from electrical overload damage by fuses.

This vehicle has 2 (or 3) fuse panels, one located in the driver's side panel bolster, the other in the engine compartment.

If any of your vehicle's lights, accessories, or controls do not work, check the appropriate circuit fuse. If a fuse has blown, the element inside the fuse is melted or broken.

If the electrical system does not work, first check the driver's side fuse panel. Before replacing a blown fuse, turn off the engine and all switches, and then disconnect the negative battery cable. Always replace a blown fuse with one of the same rating.

If the replacement fuse blows, this indicates an electrical problem. Avoid using the system involved and we recommend that you contact a HYUNDAI authorised dealer.

### WARNING

Never replace a fuse with anything but another fuse of the same rating.

- A higher capacity fuse may cause damage and possibly cause a fire.
- Do not install a wire or aluminium foil instead of the proper fuse - even as a temporary repair. It may cause extensive wiring damage and possibly a fire.

### NOTICE

Do not use a screwdriver or any other metal object to remove fuses because it may cause a short circuit and damage the system.



## Instrument panel fuse replacement

1. Turn off the vehicle.
2. Turn off all other switches.
3. Open the fuse panel cover.



4. Refer to the label on the inside of the fuse panel cover to locate the suspected fuse location.



5. Pull the suspected fuse straight out. Use the removal tool provided in the engine compartment fuses panel cover.
6. Check the removed fuse and replace it if it is blown. Spare fuses are provided in the instrument panel fuse panels (or in the engine compartment fuse panel).
7. Push in a new fuse of the same rating, and make sure it fits tightly in the clips. If it is not tight, we recommend that you contact a HYUNDAI authorised repairer.

In an emergency, if you do not have a spare fuse, use a fuse of the same rating from a circuit you may not need for operating the vehicle.

If the headlights or other electrical components do not work and the fuses are undamaged, check the fuse panel in the engine compartment.

## Engine compartment panel fuse replacement

### **Blade fuse / Cartridge fuse**

1. Turn off the vehicle.
2. Turn off all other switches.
3. Remove the fuse panel cover by pressing the tap and pulling up.
4. Refer to the label on the inside of the fuse panel cover to locate the suspected fuse location.

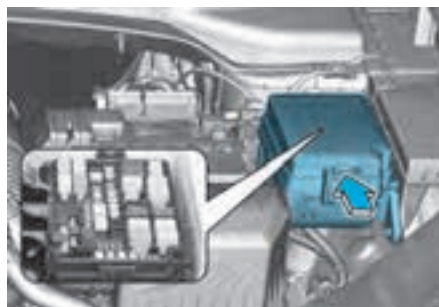

5. Pull the suspected fuse straight out. Use the removal tool provided in the engine compartment fuses panel cover.
6. Check the removed fuse and replace it if it is blown. To remove or insert the fuse, use the fuse puller in the engine compartment fuse panel.
7. Push in a new fuse of the same rating, and make sure it fits tightly in the clips. If it is not tight, we recommend that your vehicle be inspected by a HYUNDAI authorised repairer.

**NOTICE**

Always securely install the fuse panel cover. Water may contact the fuse and cause an electrical failure.

---

**i Information**

If the main fuse is blown, we recommend that you contact a HYUNDAI authorised dealer.

---

**Main fuse (Multi fuse)**

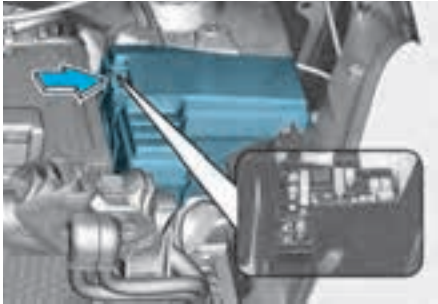

If the multi fuse or midi fuse is blown, we recommend that you contact an authorised HYUNDAI dealer.

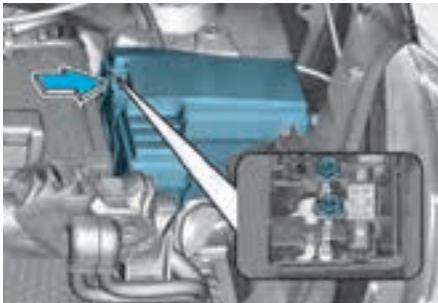

If the main fuse is blown, it must be removed as follows:

1. Disconnect the negative battery cable.
2. Remove the nuts shown in the picture above.
3. Replace the fuse with a new one of the same rating.
4. Reinstall in the reverse order of removal.

## Fuse/relay panel description

### *Instrument panel fuse panel*



Inside the fuse panel cover, you can find the fuse/relay label describing fuse/relay names and ratings.









#### ***i*** Information





Not all fuse panel descriptions in this manual may be applicable to your vehicle. When you inspect the fuse panel on your vehicle, refer to the fuse panel label in your vehicle.





---







**Instrument panel fuse panel**

Fuse Name	Symbol	Fuse Rating	Circuit Protected
REAR AIR VENTILATION	REAR 	10 A	Rear Seat RH Control Module
TAILGATE		10 A	Tailgate Relay
DOOR LOCK		20 A	Door Lock/Unlock Relay
ISG	ISG	10 A	Instrument Cluster, Front A/C Control Module, Front Smart Phone Wireless Charger, Audio, A/V & Navigation Head Unit, ADAS Unit (Parking), ADAS Unit (Parking)
AIRBAG IND.	IND 	7.5 A	Instrument Cluster
AIRBAG		15 A	SRS Control Module
USB CHARGER1	1 USB CHARGER	10 A	Luggage USB Charger RH, Rear USB Charger
MODULE6	6 MODULE	7.5 A	IBU, IAU
SAFETY P/WINDOW LH	SAFETY LH 	25 A	Driver Safety Power Window Module (LHD)
SAFETY P/WINDOW RH	SAFETY RH 	25 A	Driver Safety Power Window Module (RHD)
MODULE 1	1 MODULE	7.5 A	Data Link Connector, Rain Sensor, Driver/passenger Power Outside Mirror, Driver IMS Control Module, Outside Mirror Folding/Unfolding Relay
FRONT AIR VENTILATION	FRNT 	10 A	Front Air Ventilation Seat Control Module

Fuse Name	Symbol	Fuse Rating	Circuit Protected
A/C2	<sup>2</sup> A/C	10 A	Front A/C Control Module, Blower Resistor, Blower Motor, E/R Junction Block (RLY. 15)
MODULE4	<sup>4</sup> MODULE	7.5 A	Front Radar, Rear Radar LH/RH, Dosing Control Module, ESP Control Switch, Crash Pad Switch, Electric Parking Brake Switch, Console Switch RH, Drive Switch
MODULE3	<sup>3</sup> MODULE	7.5 A	IAU, A/T Shift Lever
USB CHARGER2	<sup>2</sup> USB CHARGER	10 A	Front USB Charger, Front Smart Phone Wireless USB Charger
REAR WIPER		15 A	Rear Wiper Motor, E/R Junction Block (RLY. 17)
P/WINDOW RH	<sup>RH</sup> 	25 A	Power Window Main Switch, Passenger Power Window Switch(LHD)
AMP	<b>AMP</b>	25 A	AMP
FRONT WIPER1	<sup>1</sup> 	10 A	IBU, ECM/PCM, Front Wiper Motor, E/R Junction Block (RLY. 9)
IBU1	<sup>1</sup> IBU	15 A	IBU, IAU, Driver Door NFC Module
MULTIMEDIA	MULTI MEDIA	15 A	Audio, A/V & Navigation Head Unit
ABS		10 A	ABS Control Module, ESP Control Module
CLUSTER	CLUSTER	7.5 A	Instrument Cluster

Fuse Name	Symbol	Fuse Rating	Circuit Protected
MODULE2	2 MODULE	10 A	AMP, Luggage USB Charger LH, Power Outside Mirror Switch, IBU, Audio, A/V & Navigation Head Unit, ADAS Unit (Parking), Emergency Call (E-Call) Unit, IAU, Console Keyboard Unit (Audio), Front A/C Control Module, Low DC-DC Converter, E/R Junction Block (RLY. 11-1)
A/C1	1 A/C	7.5 A	Front A/C Control Module, E/R Junction Block (RLY. 15), PM Sensor
SUNROOF		20 A	Sunroof Glass Motor
P/WINDOW LH	LH 	25 A	Power Window Main Switch, Passenger Power Window Switch(LHD)
DRIVER P/SEAT	DRV 	30 A	Driver Power Seat Switch, Driver IMS Control Module
START		7.5 A	ECM/PCM, IBU, E/R Junction Block (RLY. 2), Transaxle Range Switch, Ignition Lock & Clutch Switch
REAR A/C	REAR A/C	10 A	E/R Junction Block (RLY. 11-2)
MEMORY1	1 MEMORY	10 A	Emergency Call (E-Call) Unit, Built-In Camera, ADAS Unit (Parking)
MODULE5	5 MODULE	10 A	Audio, A/V & Navigation Head Unit, Front A/C Control Module, Head Lamp LH/RH, AMP, Front Air Ventilation Seat Control Module, Driver IMS Control Module, Rear Seat LH Control Module
MDPS		7.5 A	MDPS Unit
P/OUTLET 1	1 POWER OUTLET	20 A	Front Power Outlet #1
MODULE7	7 MODULE	7.5 A	E/R Junction Block (RLY. 11-2), Ionizer

Fuse Name	Symbol	Fuse Rating	Circuit Protected
WASHER		15 A	Multifunction Switch
PASSENGER P/SEAT		30 A	Passenger Power Seat Module, Passenger Seat Manual Switch
REAR DEFOGGER		10 A	Front A/C Control Module, Driver/Passenger Power Outside Mirror, ECM/PCM
BRAKE SWITCH	BRAKE SWITCH	10 A	IBU, Stop Lamp Switch
MEMORY2	<sup>2</sup> MEMORY	10 A	Instrument Cluster, Front A/C Control Module, Low DC-DC Converter
IG1	IG1	25 A	E/R Junction Block (Fuse - F33/F34-1/F34-2/F35)
IBU2	<sup>2</sup> IBU	7.5 A	IBU
MODULE8	<sup>8</sup> MODULE	10 A	ADAS Unit (Parking), DBC & SVM Switch, Console Switch RH
FRONT WIPER2	<sup>2</sup> 	25 A	Front Wiper Motor, E/R Junction Block (RLY. 9)



**Engine compartment fuse panel (Engine compartment junction block)**

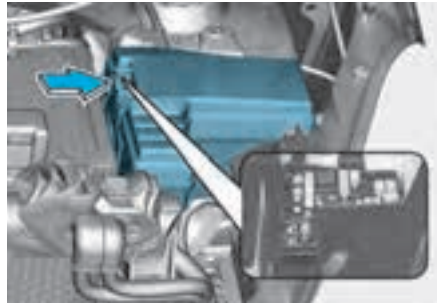

Inside the fuse panel cover, you can find the label describing fuse names and ratings.

**i Information**



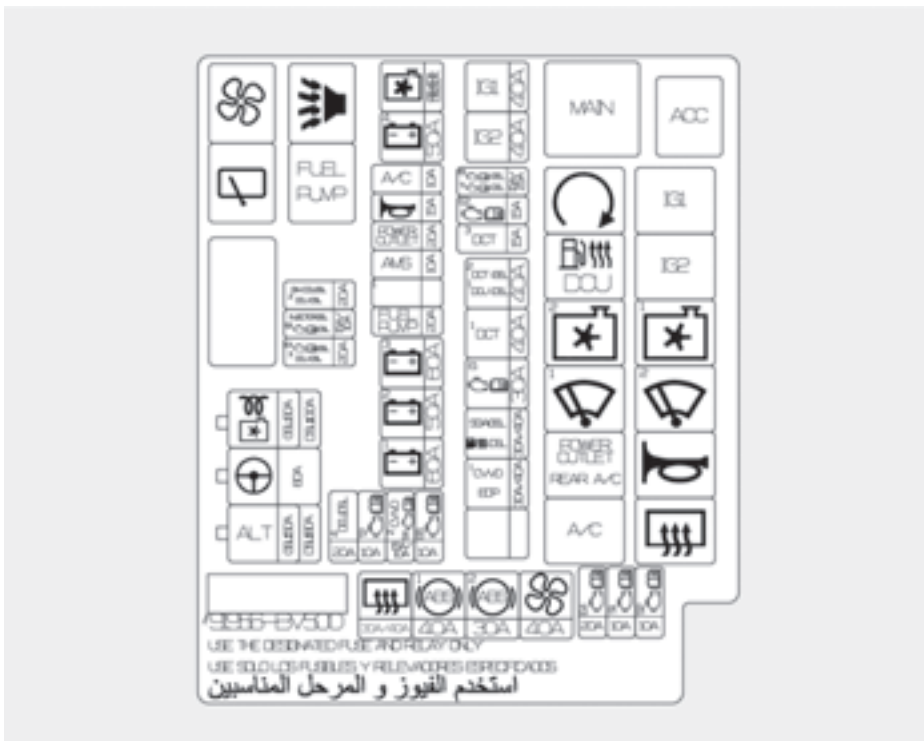



Not all fuse panel descriptions in this manual may be applicable to your vehicle. When you inspect the fuse panel on your vehicle, refer to the fuse panel label in your vehicle.













**Engine compartment fuse panel (Relay)**







Relay No.	Symbol	Type	Relay Name
E61 (RLY. 1)	<b>MAIN</b>	MINI	Main Relay
E62 (RLY. 2)	<b>ACC</b>	MICRO	ACC Relay
E63 (RLY. 3)			Start Relay
E64 (RLY. 4)	<b>IG1</b>		IG1 Relay
E65-1 (RLY. 5-1)			Fuel Filter Heater Relay
E65-2 (RLY. 5-2)	<b>DCU</b>		DCU Relay
E66 (RLY. 6)	<b>IG2</b>		IG2 Relay
E67 (RLY. 7)			Cooling Fan #2 Relay
E68 (RLY. 8)			Cooling Fan #1 Relay
E69 (RLY. 9)			Wiper High Relay









## Maintenance

Relay No.	Symbol	Type	Relay Name
E70 (RLY. 10)	<sup>2</sup> 	MICRO	Wiper Low Relay
E71-1 (RLY. 11-1)	POWER OUTLET		Power Outlet Relay
E71-2 (RLY. 11-2)	REAR A/C		Rear A/C Relay
E72 (RLY. 12)			Horn Relay
E73 (RLY. 13)	A/C		A/C Relay
E74 (RLY. 14)			Rear Defogger Relay
E75 (RLY. 15)			Blower Relay
E76 (RLY. 16)			Burglar Alarm Horn Relay
E77 (RLY. 17)			Rear Wiper Relay
E78 (RLY. 18)	FUEL PUMP		Fuel Pump Relay

### Engine compartment fuse panel

Fuse Name	Symbol	Fuse Rating	Circuit Protected
ALT	ALT	150 A	Alternator, Fuse - F4/F5/F6/F7
MDPS		80 A	MDPS Unit
C/FAN		80 A	Cooling Fan Controller
GLOW		100 A	Glow Relay Unit
REAR DEFOGGER		30 A/40 A	RLY. 14 (Rear Defogger Relay)
ABS1	<sup>1</sup> 	40 A	ABS Control Module, ESP Control Module
ABS2	<sup>2</sup> 	30 A	ABS Control Module, ESP Control Module
BLOWER		40 A	RLY. 15 (Blower Relay)
ECU4	<sup>E4</sup> 	20 A	ECM
SENSOR1	<sup>S1</sup> 	10 A	RLY. 18 (Fuel Pump Relay), Inlet Metering Valve
SENSOR2	<sup>S2</sup> 	10 A	RLY. 13/RLY. 8/RLY. 7/RLY. 5-1 (A/C Relay/Cooling Fan #2 Relay/Cooling Fan #1 Relay/Fuel Filter Heater Relay), Stop Lamp Switch, Camshaft Position Sensor, Lambda Sensor (Up/Down)
CVVD1	CVVD1	40 A	CVVD Actuator
EOP	EOP	30 A	Electronic Oil Pump

Fuse Name	Symbol	Fuse Rating	Circuit Protected
SGA	<b>SGA</b>	40 A	Smart Gear Actuator
FUEL FILTER HEATER		30 A	RLY. 5-1 (Fuel Filter Heater Relay)
ECU1	E1 	30 A	RLY. 1 (Main Relay)
DCT1	<b>DCT1</b>	40 A	TCM
DCT2	<b>DCT2</b>	40 A	TCM
DCU1	<b>DCU1</b>	40 A	RLY. 5-2 (DCU Relay)
DCT3	<b>DCT3</b>	15 A	TCM
ECU2	E2 	15 A	ECM
ECU5	E5 	15 A	ECM/PCM
ECU5	T1 	15 A	TCM
IG2	<b>IG2</b>	40 A	RLY. 3/RLY. 6 (Start Relay/IG2 Relay), Ignition Switch
IG1	<b>IG1</b>	40 A	RLY. 2/RLY. 4 (ACC Relay/IG1 Relay), Ignition Switch
B+1	<sup>1</sup> 	60 A	ICU Junction Block (IPS1/IPS4/IPS8/IPS9/IPS10/IPS12)
B+2	<sup>2</sup> 	50 A	ICU Junction Block (IPS2/IPS5/IPS6/IPS7/IPS11)

Fuse Name	Symbol	Fuse Rating	Circuit Protected
B+3	<sup>3</sup> 	60 A	ICU Junction Block (Long Term Load Auto Cut Relay, Fuse - F3/F12/F13/F23/F33/F42)
FUEL PUMP	FUEL PUMP	20 A	RLY. 18 (Fuel Pump Relay)
AMS	AMS	10 A	Battery Sensor
POWER OUTLET	POWER OUTLET	20 A	RLY. 11-1 (Power Outlet Relay)
HORN		15 A	RLY. 12/RLY. 16 (Horn Relay/Burglar Alarm Horn Relay)
A/C	A/C	10 A	RLY. 13 (A/C Relay)
B+4	<sup>4</sup> 	50 A	ICU Junction Block (Power Window Main Relay Unit)
C/FAN		40 A	RLY. 7/RLY. 8 (Cooling Fan #2 Relay/Cooling Fan #1 Relay)
ECU6	<sup>E6</sup> 	10 A	ECM/PCM
CVVD2	CVVD2	10 A	CVVD Actuator
SENSOR4	<sup>S4</sup> 	10 A	Glow Relay Unit, Fuel Filter Warning Sensor
ECU6	<sup>T2</sup> 	10 A	TCM, Transaxle Range Switch
ECU3	<sup>E3</sup> 	20 A	PCM
DCU4	DCU4	20 A	Dosing Control Module

## Maintenance

---

Fuse Name	Symbol	Fuse Rating	Circuit Protected
DCU3	<b>DCU3</b>	20 A	Dosing Control Module
INJECTOR	INJECTOR	15 A	Injector #1/#2/#3/#4
SENSOR3	S3 	10 A	EGR Cooling Bypass Solenoid Valve, PM Sensor, Mass Air Flow Sensor, Electronic VGT Actuator, Front/Rear Nox Sensor
IGN COIL	IGN COIL	20 A	Ignition Coil #1/#2/#3/#4
DCU2	<b>DCU2</b>	20 A	Dosing Control Module

## Light bulbs

We recommend that you contact a HYUNDAI authorised repairer to replace most vehicle light bulbs. It is difficult to replace vehicle light bulbs because other parts of the vehicle must be removed before you can get to the bulb. This is especially true for removing the headlight assembly to get to the bulb(s).

Removing/installing the headlight assembly may result in damage to the vehicle.

### WARNING

- Prior to replacing a light bulb, depress the brake pedal, shift to P (Park), apply the parking brake, press the Engine Start/Stop button to the OFF position and take the key with you when leaving the vehicle to avoid sudden movement of the vehicle and to prevent possible electric shock.
- Be aware the bulbs may be hot and may burn your fingers.

### NOTICE

Be sure to replace the burned-out bulb with one of the same wattage to prevent damage to the fuse or electrical wiring system.

### NOTICE

To prevent damage, do not clean the headlight lens with chemical solvents or strong detergents.

### *i* Information

The headlight and tail light lenses could appear to have condensation inside if the vehicle is washed after driving or if the vehicle is driven in wet weather. This condition is caused by a higher temperature inside the light and a cooler outside temperature. Moisture that condenses in the light is removed after driving with the light on. If the moisture is not removed, we recommend that you have the vehicle inspected by a HYUNDAI authorised repairer.

### *i* Information

- A normally functioning light may flicker momentarily to stabilize the vehicle's electrical control system. If the light goes out, or continues to flicker, we recommend that you have the system checked by a HYUNDAI authorised repairer.
- The parking light may not turn on when the parking light switch is turned on, but the parking light and headlight switch may turn on when the headlight switch is turned on. This may be caused by network failure or vehicle electrical control system malfunction. If this occurs, we recommend that you have the system checked by a HYUNDAI authorised repairer.

### *i* Information

Adjust the headlight aim after an accident or the headlight is replaced.



**⚠ WARNING**

- Handle halogen bulbs with care. Halogen bulbs contain pressurized gas that will produce flying pieces of glass that could cause injuries if broken.
- Wear eye protection when changing a bulb. Allow the bulb to cool down before handling it.
- Always handle them carefully, and avoid scratches and abrasions. If the bulbs are lit, avoid contact with liquids.
- Never touch the glass with bare hands. Residual oil may cause the bulb to overheat and burst when lit.
- A bulb should be operated only when installed in a headlight.
- If a bulb becomes damaged or cracked, replace it immediately and carefully dispose of it.

## Headlight, Position light, Turn signal light, Daytime running light (DRL) replacement

### Type A



- (1) Headlight (Low)
- (2) Headlight (High)
- (3) Position light
- (4) Turn signal light

### Headlight (Low/High)

If the headlight does not operate, we recommend that you have the system checked by a HYUNDAI authorised repairer.

### Turn signal light



1. Open the hood.
2. Disconnect the negative battery cable.
3. Loosen the pin-type retainers and screws of the front wheel guard and then detach it from the front bumper.
4. Reach your hand into the back of the front bumper.
5. Remove the socket from the assembly by turning the socket counterclockwise until the tabs on the socket align with the slots on the assembly.
6. Remove the bulb from the socket by pressing it in and rotating it counterclockwise until the tabs on the bulb align with the slots in the socket. Pull the bulb out of the socket.
7. Insert a new bulb by inserting it into the socket and rotating it until it locks into place.

### Position light

If the LED light does not operate, we recommend that you have the system inspected by a HYUNDAI authorised dealer.

The LED light cannot be replaced as a single unit. A skilled technician should check or repair the LED light, for it may damage related parts of the vehicle.

### Type B

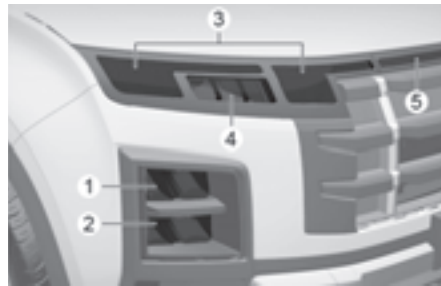

- (1) Headlight (Low)
- (2) Headlight (High)
- (3) Position light/Daytime running light (DRL)
- (4) Turn signal light
- (5) Centre position light

If the LED light does not operate, we recommend that you have the system inspected by a HYUNDAI authorised repairer.

The LED light cannot be replaced as a single unit. A skilled technician should check or repair the LED light, for it may damage related parts of the vehicle.

## Side repeater light replacement

 if equipped

### Type A



If the side repeater light does not operate, we recommend that the system be inspected by a HYUNDAI authorised repairer.

The LED light cannot be replaced as a single unit. A skilled technician should check or repair the LED light, for it may damage related parts of the vehicle.

### Type B



1. Remove the lamp assembly from the vehicle by prying the lens and pulling the assembly out.
2. Disconnect the bulb electrical connector.

3. Separate the socket and the lens parts by turning the socket counterclockwise until the tabs on the socket align with the slots on the lens part.
4. Remove the bulb by pulling it straight out.
5. Insert a new bulb in the socket.
6. Reassemble the socket and the lens part.
7. Connect the bulb electrical connector.
8. Reinstall the lamp assembly to the body of the vehicle.

## Rear combination light replacement

### Type A



- (1) Stop light
- (2) Turn signal light
- (3) Tail light
- (4) Reflector
- (5) Back up light

### Stop light and turn signal light

1. Open the tailgate.
2. Loosen the light assembly retaining screws with a cross-tip screwdriver.



3. Remove the rear combination light assembly from the body of the vehicle.



4. Remove the socket from the assembly by turning the socket counterclockwise until the tabs on the socket align with the slots on the assembly.
5. Remove the bulb from the socket by pressing it in and rotating it counterclockwise until the tabs on the bulb align with the slots in the socket. Pull the bulb out of the socket.

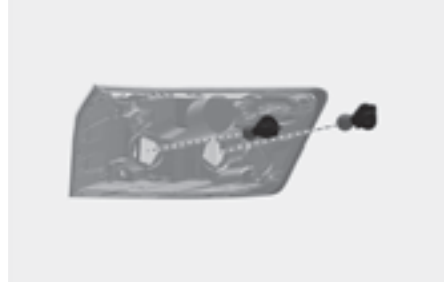

6. Insert a new bulb by inserting it into the socket and rotating it until it locks into place.
7. Install the socket in the assembly by aligning the tabs on the socket with the slots in the assembly. Push the socket into the assembly and turn the socket clockwise.
8. Reinstall the light assembly to the body of the vehicle.

### Tail light

If the LED light does not operate, we recommend that your vehicle be inspected by a HYUNDAI authorised repairer.

The LED light cannot be replaced as a single unit. A skilled technician should check or repair the LED light, for it may damage related parts of the vehicle.

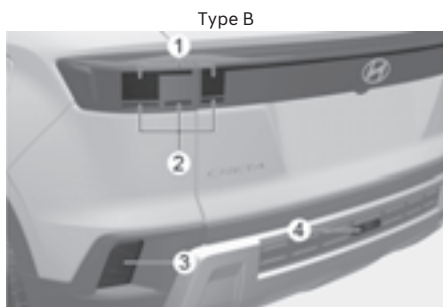

- (1) Tail/Stop light
- (2) Turn signal light
- (3) Reflector
- (4) Back up light

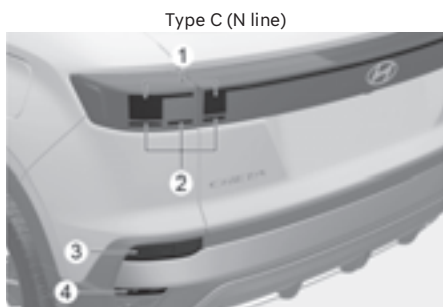

- (1) Tail/Stop light
- (2) Turn signal light
- (3) Reflector
- (4) Back up light

If the LED light does not operate, we recommend that your vehicle be inspected by a HYUNDAI authorised repairer.

The LED light cannot be replaced as a single unit. A skilled technician should check or repair the LED light, for it may damage related parts of the vehicle.

### Backup light replacement

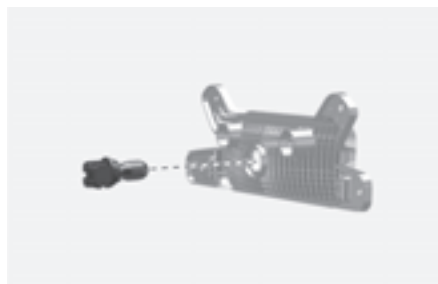

1. Loosen the pin-type retainers and screws of the rear wheel guard and then detach it from the rear bumper.
2. Reach your hand into the back of the rear bumper.
3. Remove the socket from the assembly by turning the socket counterclockwise until the tabs on the socket align with the slots on the assembly.
4. Remove the bulb from the socket by pressing it in and rotating it counterclockwise until the tabs on the bulb align with the slots in the socket. Pull the bulb out of the socket.
5. Insert a new bulb by inserting it into the socket and rotating it until it locks into place.
6. Install the socket in the assembly by aligning the tabs on the socket with the slots in the assembly. Push the socket into the assembly and turn the socket clockwise.

If the LED light does not operate, we recommend that you have the system inspected by a HYUNDAI authorised repairer.

The LED light cannot be replaced as a single unit. A skilled technician should check or repair the LED light, for it may damage related parts of the vehicle.

### High mounted stop light replacement



If the LED light does not operate, we recommend that you have the system inspected by a HYUNDAI authorised repairer.

The LED light cannot be replaced as a single unit. A skilled technician should check or repair the LED light, for it may damage related parts of the vehicle.

### License plate light replacement

#### *License plate light (bulb type)*

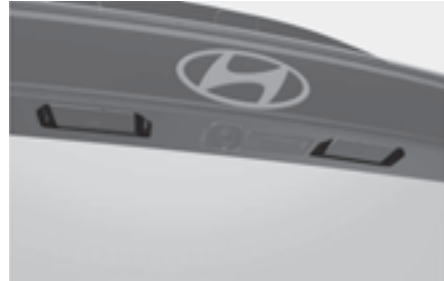

1. Using Trim remover, gently pry the Snaps of Lamp Housing such that lamp comes out.
2. Remove the socket from the housing by turning it counterclockwise.
3. Push down the connector clip and pull the connector to remove it from the socket.
4. Install a new bulb and reinstall in the reverse order.

## Interior light replacement

### Map lamp and personal lamp (LED type)

Map lamp



Personal lamp



If the LED lamp (1) does not operate, we recommend that the system be checked by an authorised HYUNDAI dealer.

The LED lamps cannot be replaced as a single unit because it is an integrated unit. The LED lamps has to be replaced with the unit.

A skilled technician should check or repair the LED lamp, for it may damage related parts of the vehicle.

If the LED lamp does not operate, we recommend that your vehicle be inspected by a HYUNDAI authorised repairer.

The LED light cannot be replaced as a single unit. A skilled technician should check or repair the LED light, for it may damage related parts of the vehicle.

### Map lamp, room lamp and luggage compartment lamp (bulb type)

#### WARNING

Prior to working on the Interior Lights, ensure that the "OFF" button is depressed to avoid burning your fingers or receiving an electric shock.

Map lamp



1. Open the Sunglass Holder and find 2 Screws on the Body surface.
2. Loose the lamp assembly retaining screws with a cross-tip screwdriver.
3. Remove the overhead console lamp assembly from the Headlining.
4. Remove the bulb from the bulb base by rotating it counterclockwise. Pull the bulb out of the socket.
5. Insert a new bulb by inserting it into the bulb base and rotating it until it locks into place.
6. Remove the Blue Clips from the Roof Panel & Screw them to the Lamp Assembly using the crosstip screw driver.
7. Assemble the overhead console lamp assembly into the Headlining by pushing & making sure that the clips are locked in place.
8. Insert the outer cover into the housing.

Room lamp

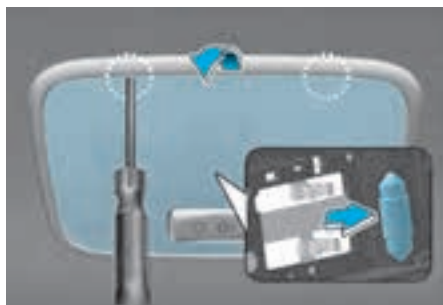

Luggage compartment lamp



1. Using a flat-head screwdriver, gently pry the lens from the interior light housing.
2. Remove the bulb by pulling it straight out.
3. Install a new bulb into the socket.
4. Align the lens tabs with the interior light housing notches and snap the lens into place.

If the lamps do not operating, have the vehicle checked by an authorised HYUNDAI dealer.

### **NOTICE**

Use care not to dirty or damage lenses, lens tabs, and plastic housings.

---

## Appearance care

### Exterior care

#### **Exterior general caution**

It is very important to follow the label directions when using any chemical cleaner or polish. Read all warning and caution statements that appear on the label.

#### **Finish maintenance**

##### **Washing**

To help protect your vehicle's finish from rust and deterioration, wash it thoroughly and frequently at least once a month with lukewarm or cold water.

If you use your vehicle for off-road driving, you should wash it after each off-road trip. Pay special attention to the removal of any accumulation of salt, dirt, mud, and other foreign materials. Make sure the drain holes in the lower edges of the doors and rocker panels are kept clear and clean.

Insects, tar, tree sap, bird droppings, industrial pollution, and similar deposits may damage your vehicle's finish if not removed immediately.

Even prompt washing with plain water may not completely remove all these deposits. Use a mild soap, safe for use on painted surfaces.

After washing, rinse the vehicle thoroughly with lukewarm or cold water. Do not allow soap to dry on the finish.

### **NOTICE**

High pressure water may damage front and rear cameras, sensors, vehicle trim, and boots (rubber or plastic covers) or connectors.

---



**⚠ WARNING**

After washing the vehicle, dry the brakes by applying them lightly whilst maintaining a slow forward speed.

**NOTICE**

- Do not use strong soap, chemical detergents, or hot water, and do not wash the vehicle in direct sunlight or when the body of the vehicle is warm.
- To prevent damage to the plastic parts, do not clean with chemical solvents or strong detergents.

**NOTICE**

- Water washing in the engine compartment including high pressure water washing may cause the failure of electrical circuits located in the engine compartment.
- Never allow water or other liquids to come in contact with electrical/ electronic components inside the vehicle to prevent damage.

**NOTICE**

Matte paint finish vehicle (if equipped)  
Automatic car wash which uses rotating brushes should not be used as this can damage the surface of your vehicle. A steam cleaner which washes the vehicle surface at high temperature may result the oil to adhere and leave stains that is difficult to remove.

Use a soft cloth (for example, microfiber towel or sponge) when washing your vehicle and dry with a microfiber towel. When you hand wash your vehicle, you should not use a cleaner that finishes with wax. If the vehicle surface is too dirty (sand, dirt, dust, contaminant, etc.), clean the surface with water before washing the car.

**Waxing**

A good coat of wax helps protect your paint from contaminants.

Wax the vehicle when water no longer beads on the paint.

Always wash and dry the vehicle before waxing. Use a good quality liquid or paste wax, and follow the manufacturer's instructions. Wax all metal trim to protect it and to maintain its luster.

Removing oil, tar, and similar materials with a spot remover usually strips the wax from the finish. Be sure to re-wax these areas even if the rest of the vehicle does not yet need waxing.

**NOTICE**

- Do not wipe dust or dirt off the body with a dry cloth to prevent scratching the finish.
  - Do not use steel wool, abrasive cleaners, or strong detergents containing highly alkaline or caustic agents on chrome-plated or anodized aluminium parts to prevent discolouration or paint deterioration.
- 

**NOTICE**

Matte paint finish vehicle (if equipped)

Do not use any polish protector such as detergent, abrasive, or polish. If wax is applied, remove the wax immediately using a silicone remover. If any tar or tar contaminant is on the surface, use a tar remover to clean.

Be careful not to apply too much pressure on the painted area.

---

**Finish damage repair**

Deep scratches or stone chips on the painted surface must be repaired promptly. Exposed metal quickly rusts and may develop into a major repair expense.

**NOTICE**

If your vehicle is damaged and requires any metal repair or replacement, make sure the body shop applies anti-corrosion materials to the parts repaired or replaced.

---

**NOTICE**

Matte paint finish vehicle (if equipped)

It is impossible to modify only repaint the damaged area. The whole part must be repainted as necessary. If the vehicle is damaged and painting is required, we recommend that you have your vehicle maintained and repaired by a HYUNDAI authorised repairer. Take extreme care, as it is difficult to restore the quality after the repair.

---

### ***Bright-metal maintenance***

- To remove road tar and insects, use a tar remover, not a scraper or other sharp object.
- To protect the surfaces of bright metal parts from corrosion, apply a coating of wax or chrome preservative and rub to a high luster.
- During winter weather or in coastal areas, cover the bright metal parts with a heavier coating of wax or preservative. If necessary, coat the parts with non-corrosive petroleum jelly or other protective compound.

### ***Underbody maintenance***

Corrosive materials used for ice and snow removal and dust control may collect on the underbody. If these materials are not removed, accelerated rusting may occur on underbody parts such as fuel lines, frame, floor pan, and exhaust system, even though they have been treated with rust protection.

Thoroughly flush the vehicle underbody and wheel openings with lukewarm or cold water once a month, after off-road driving and at the end of each winter. Pay special attention to these areas because it is difficult to see all the mud and dirt. It does more harm than good to wet down the road grime without removing it. The lower edges of doors, rocker panels, and frame members have drain holes that must not be allowed to clog with dirt. Trapped water in these areas may cause rusting.

### ***Aluminium wheel maintenance***

The aluminium wheels are coated with a clear protective finish.

- Do not use abrasive cleaner, polishing compound, solvent, or wire brushes on aluminium wheels.
- Clean the wheel when it has cooled.
- Use only a mild soap or neutral detergent, and rinse thoroughly with water. Also, clean the wheels after driving on salted roads.
- Do not wash the wheels with high speed car wash brushes.
- Do not use any cleaners containing acid or alkaline detergents.

### ***Corrosion protection***

#### ***Protecting your vehicle from corrosion***

By using the most advanced design and construction practices to combat corrosion, HYUNDAI produces vehicles of the highest quality. However, this is only part of the job. To achieve the longterm corrosion resistance your vehicle can deliver, the owner's cooperation and assistance are also required.

#### ***Common causes of corrosion***

The most common causes of corrosion on your vehicle are:

- Road salt, dirt and moisture that is allowed to accumulate underneath the vehicle.
- Removal of paint or protective coatings by stones, gravel, abrasion or minor scrapes and dents which leave unprotected metal exposed to corrosion.

### **High-corrosion areas**

If you live in an area where your vehicle is regularly exposed to corrosive materials, corrosion protection is particularly important. Some of the common causes of accelerated corrosion are road salts, dust control chemicals, ocean air and industrial pollution.

### **Moisture breeds corrosion**

Moisture creates the conditions in which corrosion is most likely to occur. For example, corrosion is accelerated by high humidity, particularly when temperatures are just above freezing. In such conditions, the corrosive material is kept in contact with the vehicle surfaces by moisture that is slow to evaporate.

Mud is particularly corrosive because it is slow to dry and holds moisture in contact with the vehicle. Although the mud appears to be dry, it can still retain moisture and promote corrosion.

High temperatures can also accelerate corrosion of parts that are not properly ventilated so the moisture can be dispersed. For all these reasons, it is particularly important to keep your vehicle clean and free of mud or accumulations of other materials. This applies not only to the visible surfaces but particularly to the underside of the vehicle.

### **To help prevent corrosion**

#### **Keep your vehicle clean**

The best way to prevent corrosion is to keep your vehicle clean and free of corrosive materials. Attention to the underside of the vehicle is particularly important.

- If you live in a high-corrosion area - where road salts are used, near the ocean, areas with industrial pollution, acid rain, etc.-, you should take extra care to prevent corrosion. In winter, hose off the underside of your vehicle at least once a month and be sure to clean the underside thoroughly when winter is over.
- When cleaning underneath the vehicle, pay particular attention to the components under the fenders and other areas that are hidden from view. Do a thorough job; just dampening the accumulated mud rather than washing it away will accelerate corrosion rather than prevent it. Water under high pressure and steam are particularly effective in removing accumulated mud and corrosive materials.
- When cleaning lower door panels, rocker panels and frame members, be sure that drain holes are kept open so that moisture can escape and not be trapped inside to accelerate corrosion.

Keep your garage dry

Don't park your vehicle in a damp, poorly ventilated garage. This creates a favorable environment for corrosion. This is particularly true if you wash your vehicle in the garage or drive it into the garage when it is still wet or covered with snow, ice or mud. Even a heated garage can contribute to corrosion unless it is well ventilated so moisture is dispersed.

Keep paint and trim in good condition

Scratches or chips in the finish should be covered with "touch-up" paint as soon as possible to reduce the possibility of corrosion. If bare metal is showing through, the attention of a qualified body and paint shop is recommended.

Bird droppings are highly corrosive and may damage painted surfaces in just a few hours. Always remove bird droppings as soon as possible.

## Interior care

### **Interior general precautions**

Prevent caustic solutions such as perfume and cosmetic oil, from contacting the interior parts because they may cause damage or discoloration. If they do contact the interior parts, wipe them off immediately. Refer to the instructions for the proper way to clean vehicle interior surfaces.

### **NOTICE**

- Never allow water or other liquids to come in contact with electrical/electronic components inside the vehicle because this may damage them.
- When cleaning leather products (steering wheel, seats, etc.), use neutral detergents or low alcohol content solutions. If you use high alcohol content solutions or acid/alkaline detergents, the colour of the leather may fade or the surface may get stripped off.

### **Cleaning the upholstery and interior trim**

#### **Vehicle interior surfaces**

 if equipped

Remove dust and loose dirt from interior surfaces with a whisk broom or a vacuum cleaner.

If necessary, clean interior surfaces with a mixture of warm water and mild non-detergent cleaner (test all cleaners on a concealed area before use).

#### **Fabric**

 if equipped

Remove dust and loose dirt from fabric with a whisk broom or vacuum cleaner. Clean with a mild soap solution recommended for upholstery or carpets. Remove fresh spots immediately with a fabric spot cleaner. If you do not pay attention to fresh spots immediately, the fabric may be stained and its colour may be affected. Also, its fire-resistant properties may be reduced if the material is not properly maintained.

### NOTICE

Using anything but recommended cleaners and procedures may affect the fabric's appearance and fire-resistant properties.

---

### Leather

 if equipped

- Features of seat leather
  - Leather is made from the outer skin of an animal, which goes through a special process to be available for use. Since it is a natural product, each part differs in thickness or density. Wrinkles may appear as a natural result of stretching and shrinking depending on the temperature and humidity.
  - The seat is made of stretchable fabric to improve comfort.
  - The parts contacting the body are curved and the side supporting area is high which provides driving comfort and stability.
  - Wrinkles may appear naturally from usage. It is not a fault of the products.

### NOTICE

- Wrinkles or abrasions which appear naturally from usage are not covered by warranty.
  - Belts with metallic accessories, zippers or keys inside the back pocket may damage the seat fabric.
  - Make sure not to wet the seat. It may change the nature of natural leather.
  - Jeans or clothes which could bleach may contaminate the surface of the seat covering fabric.
- 

- Caring for the leather seats
  - Vacuum the seat periodically to remove dust and sand on the seat. It will prevent abrasion or damage of the leather and maintain its quality.
  - Wipe the natural leather seat cover often with dry or soft cloth.
  - Use of proper leather protector may prevent abrasion of the cover and helps maintain the colour. Be sure to read the instructions and consult a specialist when using leather coating or protective agent.
  - Light coloured (beige, cream beige) leather is easily contaminated and the stain is noticeable. Clean the seats frequently.
  - Avoid wiping with wet cloth. It may cause the surface to crack.
- Cleaning the leather seats
  - Remove all contaminations instantly. Refer to instructions below for removal of each contaminant.
  - Cosmetic products (sunscreen, foundation, etc.)  
Apply cleansing cream on a cloth and wipe the contaminated spot. Wipe off the cream with a wet cloth and remove water with a dry cloth.
  - Beverages (coffee, soft drink, etc.)  
Apply a small amount of neutral detergent and wipe until contaminations do not smear.
  - Oil  
Remove oil instantly with absorbable cloth and wipe with stain remover used only for natural leather.
  - Chewing gum  
Harden the gum with ice and remove gradually.

### ***Interior wooden trim***

- Use a wooden furniture protector (for example, wax, coating compound) to clean the interior wooden trim.
- Often wipe the interior wooden trim with a lint-free, clean cloth to maintain the unique wooden textures for a longer period of time.
- If you spill beverage (for example, water, coffee) over the interior wooden trim, immediately wipe it with clean, dry cloth.
- Sharp objects (for example, driver, knife), adhesive materials, or tapes may damage the interior wooden trim.
- Any strong impacts may damage the interior wooden trim.
- If the coating finish over the interior wooden trim is removed, moisture may damage or change wood traits.
- If the interior wooden trim is damaged, you may get a splinter from the wood surface. We recommend that you have the damaged interior wooden trim replaced by a HYUNDAI authorised repairer.

### ***Cleaning the seat belt webbing***

Clean the belt webbing with any mild soap solution recommended for cleaning upholstery or carpet. Follow the instructions provided with the soap.

#### **WARNING**

Do not bleach or re-dye the webbing because this may weaken the seat belt.

---

### ***Cleaning the interior window glass***

If the interior glass surfaces need to be cleaned, use a glass cleaner. Follow the directions on the glass cleaner container.

#### **NOTICE**

Do not scrape or scratch the inside of the rear window. This may result in damage to the rear window defroster grid.

---

## Emission control system

The emission control system of your vehicle is covered by a written limited warranty. Please see the warranty information contained in the Service Passport in your vehicle.

Your vehicle is equipped with an emission control system to meet all applicable emission regulations. There are three emission control systems, as follows:

- Crankcase emission control system
- Evaporative emission control system
- Exhaust emission control system

In order to ensure the proper function of the emission control systems, it is recommended that you have your vehicle inspected and maintained by a HYUNDAI authorised repairer in accordance with the Maintenance schedule at the Service Passport in your vehicle.

### **NOTICE**

For the Inspection and Maintenance Test (with Electronic Stability Control (ESC) system)

- To prevent the vehicle from misfiring during dynamometer testing, turn the Electronic Stability Control (ESC) system off by pressing the ESC switch (ESC OFF light illuminated).
  - After dynamometer testing is completed, turn the ESC system back on by pressing the ESC switch again.
- 

## Crankcase emission control system

The positive crankcase ventilation system is employed to prevent air pollution caused by blow-by gases being emitted from the crankcase. This system supplies fresh filtered air to the crankcase through the air intake hose. Inside the crankcase, the fresh air mixes with blow-by gases, which then pass through the PCV valve into the induction system.

## Evaporative emission control system

The Evaporative Emission Control System is designed to prevent fuel vapours from escaping into the atmosphere.

### **Canister**

Fuel vapours generated inside the fuel tank are absorbed and stored in the onboard canister. When the engine is running, the fuel vapours absorbed in the canister are drawn into the surge tank through the purge control solenoid valve.

### **Purge Control Solenoid Valve (PCSV)**

The purge control solenoid valve is controlled by the Engine Control Module (ECM); when the engine coolant temperature is low during idling, the PCSV closes so that evaporated fuel is not taken into the engine. After the engine warms-up during ordinary driving, the PCSV opens to introduce evaporated fuel to the engine.



## Exhaust emission control system

The Exhaust Emission Control System is a highly effective system which controls exhaust emissions whilst maintaining good vehicle performance.

When the engine starts or fails to start, excessive attempts to restart the engine may cause damage to the emission system.

### Vehicle modifications

- This vehicle should not be modified. Modification of your vehicle could affect its performance, safety or durability and may even violate governmental safety and emissions regulations. In addition, damage or performance problems resulting from any modification may not be covered under warranty.
- If you use unauthorized electronic devices, it may cause the vehicle to operate abnormally, wire damage, battery discharge and fire. For your safety, do not use unauthorized electronic devices.

### Engine exhaust (carbon monoxide) precautions

- Carbon monoxide can be present with other exhaust fumes. If you smell exhaust fumes of any kind in your vehicle, drive with all the windows fully open. Have your vehicle checked and repaired immediately.

#### WARNING

Engine exhaust gases contain carbon monoxide (CO). Though colourless and odourless, it is dangerous and could be lethal if inhaled. Follow the instructions on this page to avoid CO poisoning.

- Do not operate the engine in confined or closed areas (such as garages) any more than what is necessary to move the vehicle in or out of the area.
- When the vehicle is stopped in an open area for more than a short time with the engine running, adjust the ventilation system (as needed) to draw outside air into the vehicle.
- Never sit in a parked or stopped vehicle for any extended time with the engine running.
- When the engine stalls or fails to start, excessive attempts to restart the engine may cause damage to the emission control system.

### **Operating precautions for catalytic converters**

 if equipped

#### **WARNING**

The exhaust system and catalytic system are very hot whilst the engine is running or immediately after the engine is turned off. To avoid serious injury or death:

- Do not park, idle, or drive the vehicle over or near flammable objects, such as grass, vegetation, paper, leaves, etc. A hot exhaust system may ignite flammable items under your vehicle.
- Keep away from the exhaust system and catalytic converter or you may get burned.

Also, do not remove the heat sink around the exhaust system, do not seal the bottom of the vehicle, and do not coat the vehicle for corrosion control. It may present a fire risk under certain conditions.

---

Your vehicle is equipped with a catalytic converter emission control device.

#### **NOTICE**

To prevent damage to the catalytic converter and to your vehicle, take the following precautions:

- Use only UNLEADED FUEL for petrol engines.
- Do not operate the vehicle when there are signs of engine malfunction, such as misfire or a noticeable loss of performance.
- Do not misuse or abuse the engine. Examples of misuse are coasting with the engine off and descending steep grades in gear with the engine off.
- Do not operate the engine at high idle speed for extended periods (5 minutes or more).
- Do not modify or tamper with any part of the engine or emission control system. We recommend that all inspections and adjustments must be made by a HYUNDAI authorised repairer.
- Avoid driving with an extremely low fuel level.

Running out of fuel could cause the engine to misfire, damaging the catalytic converter.

Failure to follow these precautions may void your vehicle warranty.

---

### **Petrol Particulate Filter (GPF)**

 if equipped

Petrol Particulate Filter (GPF) system removes the soot in the exhaust gas.

The GPF system automatically burns (or oxidizes) the accumulated soot in accordance with driving situations, unlike a disposable air filter.

In other words, the accumulated soot is automatically purged out by the engine control system and by the high exhaust gas temperature at normal/high driving speeds.

However, when the vehicle is continually driven at repeated short distances or driven at low speed for a long time, the accumulated soot may not be automatically removed because of low exhaust gas temperature. In this case, the accumulated soot may reach a certain amount regardless of the soot oxidization process, then the GPF lamp () illuminates.

The Petrol Particulate Filter (GPF) lamp stops illuminating, when the driving speed exceeds 80 km/h (50 mph) with 1,500-4,000 RPM and the gear in the 3rd position or above for about 30 minutes.

When the GPF lamp starts to blink or the warning message “**Check exhaust system**” pops up even though the vehicle was driven as mentioned above, we recommend that you have the GPF system checked by a HYUNDAI authorised repairer.

With GPF lamp blinking for an extended period of time, it may damage the GPF system and lower the fuel economy.

### CAUTION

We recommend you to use only the regulated petrol fuels, when your vehicle is equipped with the GPF system.

When you use other petrol fuels which contain unspecified additives, they may damage the GPF system and cause exhaust emission problems.

### **Diesel Particulate Filter (DPF)**

 if equipped

The Diesel Particulate Filter (DPF) system removes the soot in the exhaust gas. Unlike a disposable air filter, the DPF system automatically burns (oxidizes) and removes the accumulated soot according to the driving condition. In other words, the active burning by engine control system and high exhaust gas temperature caused by normal/high driving condition burns and removes the accumulated soot.

However, if the vehicle continues to be driven at repeated short distance or driven at low speed for a long time, the accumulated soot may not be automatically removed because of low exhaust gas temperature. More than a certain amount of soot deposited, the malfunction indicator light () illuminates.

When the malfunction indicator light illuminates, it may turn-off after driving the vehicle at more than 60 km/h (37 mph) or at more than second gear with 1,250~2,500 RPM for a certain time (for about 30 minutes).

If the malfunction indicator light (MIL) is not turn-off or blinking continuously in spite of the procedure, visit a professional workshop and check the DPF system. HYUNDAI recommends to visit an authorized HYUNDAI dealer/service partner.

If you continue to drive with the malfunction indicator light blinking for a long time, the DPF system can be damaged and fuel consumption can be worsen and the engine durability can be worsen by oil dilution.

### CAUTION

Diesel Fuel (if equipped with DPF)

We recommend you to use only the regulated diesel fuels, when your vehicle is equipped with the DPF system.

When you use other diesel fuels, which is high in sulfurs (above 10 ppm) or contains unspecified additives, it may damage the DPF system and cause the white smoke emission.

### **Lean NOx Trap**

 if equipped

The Lean NOx Trap (LNT) system removes the nitrogen oxide in the exhaust gas. The smell can occur in the exhaust gas depending on the quality of the fuel and it can degrade NOx reduction performance, please use the regulated automotive diesel fuel.

- The LNT warning light blinks if the LNT performance is degraded. (MIL)

In this case, the warning light illuminates and the warning alarm sounds while showing a warning message “Self Regeneration” on the cluster display.

For more information, refer to “Self Regeneration Mode” in chapter 9.

Selective Catalytic Reduction (SCR)

Selective Catalytic Reduction system catalytically converts NOx to nitrogen and water by using reduction agent, urea solution.

### **DEF level / Urea level**

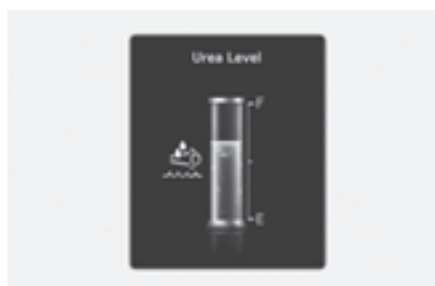

DEF (Diesel Exhaust Fluid) level gauge display shows the approximate amount of remaining urea solution inside the urea solution tank. You can check the DEF level in the Utility view on the cluster.

For more information, refer to the “Cluster display control” section in chapter 4.

### Low urea warning message

Warning message will appear in four steps on the cluster according to urea solution level in the tank.

#### First warning

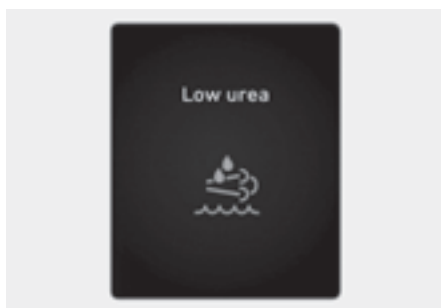

The SCR (☞) warning light and 'Low urea' warning message appears on the instrument cluster when urea level is low. Refill as soon as possible.

#### Second warning

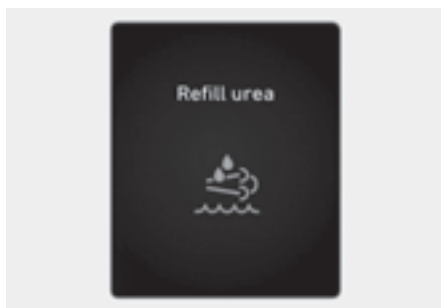

If urea is not refilled after the first warning, the SCR (☞) warning light and 'Refill urea' warning message appears on the instrument cluster when urea level is low. Refill as soon as possible.

#### Third warning

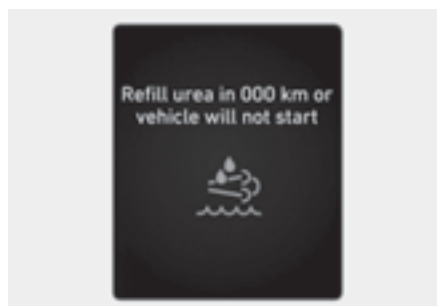

The SCR (☞) warning light and 'Refill urea in 000 km or vehicle will not start / Refill urea in 000 km. Otherwise vehicle will not start' warning message appears on the instrument cluster when urea solution tank is nearly empty. Refill immediately. The displayed driving distance (000 km) and actual driving distance may vary depending on driving habits and driving conditions.

#### Fourth warning

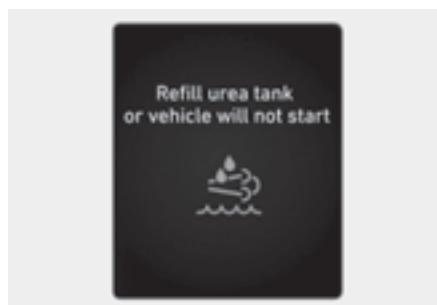

The SCR (☞) warning light and 'Refill urea tank or vehicle will not start / Refill urea tank. Otherwise vehicle will not start' warning message appears on the instrument cluster when urea solution tank is empty. The vehicle cannot be restarted once the engine is turned off. Refill immediately.

### Selective Catalytic Reduction system malfunction

When there is a problem with the Selective Catalytic Reduction system such as disconnected electrical components, use of incorrect urea, etc., the following warning message will appear on the instrument cluster. If this occurs, we recommend that the system be inspected by an authorized HYUNDAI dealer.

If you continue to drive without the problem solved, it may adversely effect system performance or the vehicle cannot be restarted once the engine is turned off.

	Malfunction	Driving 50 km after malfunction
Urea system failure (= no urea injection)	Diesel Exhaust Fluid (DEF) system failure / Urea dosing system error	Check urea system
Incorrect urea detected (= abnormal urea)	Incorrect urea detected	Refill with correct urea in 000 km or vehicle will not start / Refill correct urea in 000 km. Otherwise vehicle will not start
Abnormal urea consumption (= post treatment failure)	Check urea system	Service urea system in 000 km or vehicle will not start / Service urea system in 000 km. Otherwise vehicle will not start

### Restarting the vehicle

Vehicle restart restriction	
Low urea level	Refill urea tank or vehicle will not start / Refill urea tank. Otherwise vehicle will not start
Urea system failure (= no urea injection)	Service urea system in 000 km or vehicle will not start / Service urea system in 000 km. Otherwise vehicle will not start
Incorrect urea detected (= abnormal urea)	Refill with correct urea in 000 km or vehicle will not start / Refill correct urea in 000 km. Otherwise vehicle will not start
Abnormal urea consumption (= post treatment failure)	Service urea system in 000 km or vehicle will not start / Service urea system in 000 km. Otherwise vehicle will not start

The vehicle can be restarted after the problem is solved. If the 'Refill urea tank or vehicle will not start / Refill urea tank. Otherwise vehicle will not start' warning message appears, refill the urea solution tank. After refilling the tank, place ignition switch or Engine Start/Stop button to the ON position and wait until the message disappears. If the vehicle cannot be restarted after refilling urea, we recommend that the system be inspected by an authorised HYUNDAI dealer.

### Adding urea solution

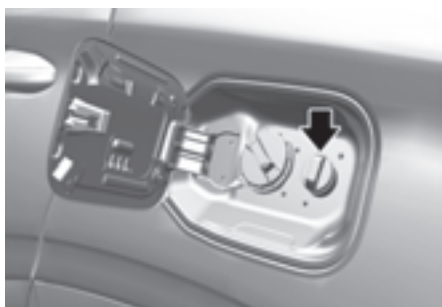

### Refilling urea with a refill hose

1. Turn the vehicle off.
2. Ensure the all doors are unlocked.
3. Press the rear centre edge of the fuel filler door.
4. Pull the fuel filler door outward to access the fuel tank cap.
5. To open the urea solution tank cap, turn it counterclockwise.
6. Fully insert the refill hose and add urea.
7. Do not overfill.
8. To close the urea solution tank cap, turn it clockwise.

### Refilling urea from a refill bottle

1. Turn the vehicle off.
2. Ensure the all doors are unlocked.
3. Press the rear centre edge of the fuel filler door.
4. Pull the fuel filler door outward to access the fuel tank cap.
5. To open the urea solution tank cap, turn it counterclockwise.
6. Add urea. Do not overfill.
7. To close the urea solution tank cap, turn it clockwise.

Use only specified urea solution (Refer to “Recommended lubricants and capacities” section in chapter 2).

### NOTICE

To prevent damage to your vehicle:

- Use only specified urea solution. Never add any other urea solution than what has been specified.
- Be careful not to add urea solution into the fuel tank.
- While adding urea, be careful not to allow foreign substances to enter into the urea solution tank.
- Do not mix water or additives with the urea solution.

Do not over fill the urea solution tank. In cold weather, the tank will expand if the urea freezes.

In this case, the warning light illuminates and the warning alarm sounds while showing a warning message “Self Regeneration” on the cluster display.

For more information, refer to the “Self Regeneration Mode” in chapter 9.

### Storing urea solution

- Store urea solution only in containers made with the following materials.
  - DIN EN 10 088-1/-2/-3-specified CR-Ni steel
  - Mo-Cr-Ni steel
  - Polypropylene
  - Polyethylene
- Do not store urea solution in containers made with the following materials.
  - Aluminum, copper, copper alloy, non-alloyed steel, and galvanized steel

Urea solution dissolves the metal materials, severely damaging the exhaust purification system.

### **i** Information

Urea solution is a water-soluble substance, which is inflammable, non-toxic, colorless and odorless.

---

### NOTICE

- The following situations may damage the DPF system.
  - Fuels or any unauthorized liquids are added to the urea solution tank
  - Additives are mixed in the urea solution
  - Water is mixed in the urea solution
- Use only specified urea solution. When any unauthorized urea solution is added to the tank, we recommend that you contact an authorized HYUNDAI dealer.
- When any foreign substances enter the urea solution tank, the following problems may occur.
  - Increased emission
  - DPF system malfunction
  - Engine failure

- Never add used urea solution as its quality cannot be guaranteed. Always add new urea solution.
- 

### **!** WARNING

- Do not apply any external impact on the DPF system. It may damage the catalyst, which is equipped inside the DPF system.
- Do not modify the DPF system by redirecting or lengthening the exhaust pipe. It may adversely affect the DPF system.
- Avoid contact with the drained water from the exhaust pipe. The water is slightly acid and harmful to skin. If contacted, thoroughly wash it off.
- Any modification of the DPF system may cause system malfunction. The DPF system is controlled by a complex device.
- Wait for the DPF system to cool down before maintenance, as it is hot due to heat generation. Otherwise, it may cause skin burn.
- The Selective Catalytic Reduction system (for example, urea solution nozzle, urea solution pump, and DCU) operates for approximately 2 minutes more to eliminate the remaining urea solution inside, even after the engine is turned OFF. Before working on the vehicle, make sure that the Selective Catalytic Reduction system is completely turned OFF.

Poor urea solution or unauthorized liquids may damage vehicle components, including the DPF system. Any unverified additives in the urea solution may clog the SCR catalyst and cause other malfunctions, which require the expensive DPF system to be replaced.

---



**⚠ WARNING**

- When the urea solution contacts with the eyes or the skin, you should thoroughly wash the contaminated skin area.
- When you swallow the urea solution, thoroughly rinse your mouth and drink a lot of freshwater. Then, immediately consult a doctor.
- When your cloth is contaminated with the urea solution, immediately change your cloth.
- When you have an allergic reaction to the urea solution, immediately consult a doctor.
- Keep children away from urea solution.
- When opening the urea solution tank cap at high outside temperatures, ammonia vapors may escape. Ammonia vapors have a pungent smell and primarily cause irritation of the:
  - Skin
  - Mucous membranes
  - Eyes

You may experience a burning sensation in your eyes, nose and throat, as well as coughing and watering of the eyes. Do not inhale ammonia vapors. Do not allow urea solution to come in direct contact with your skin. It is hazardous to your health. Wash any affected areas off with plenty of clean water. If necessary, consult a doctor.
- When handling urea solution in closed space, ensure good ventilation. When the bottle of urea solution container is opened, pungent smelling fumes may escape.

**NOTICE**

- Wipe off any urea solution spillage with water or dampened cloth. When the urea solution is crystalized, wipe it off with sponge or cloth, which is dampened in cold water.

When the urea solution spillage is exposed in the air for an extended period of time, it is crystalized in white, damaging the vehicle surface.

- When urea solution overflows onto vehicle surface, wash out vehicle surface with clean water to prohibit corrosion from occurring.
- Store the urea solution tank only in well ventilated locations. When urea solution is exposed to hot temperature at approximately 50 °C (122 °F) for an extended period of time (for example, under direct sunlight), chemical decomposition may occur, emitting ammonia vapor.
- In case the vehicle was parked at very low ambient temperature (below - 11 °C (12 °F) for a long time, the urea solution will be frozen in the urea solution tank. With frozen urea, the tank level may not be detected correctly until the urea solution melts. Incorrect urea or diluted urea may increase the freezing point, so only use specified urea solution.

The time for the urea solution to melt varies in accordance with driving conditions and outside temperatures.

## Self Regeneration Mode

### **Cluster display type**

If the warning message “Self Regeneration” is stored in inspection message tap, it is operable in cluster display warning message page.

#### **WARNING**

- Make sure the vehicle parked on safety zone. (to avoid the flammables like grass and traffic accident)
- Check remained fuel above 1/5 of full level fuel gauge to prevent fuel overheat.
- Open the hood to prevent engine room overheat.
- Self regeneration should be done only when DPF indicator illuminates.
- If the warning message “Diesel filter regeneration required, See owner’s manual.” appears on the cluster display, Self Regeneration is required.

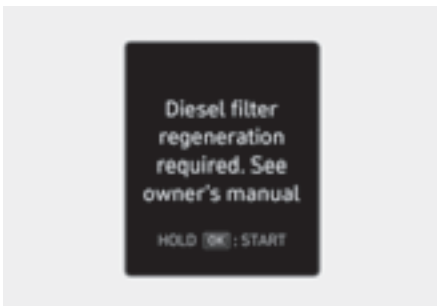

### **To initiate Self Regeneration**

1. Engage parking brake and shift lever at P state.
2. Turn on the engine.
3. Warm up the engine and check engine temperature gauge at the middle position.
4. Turn on the air conditioner and set the blower to the maximum.
5. Turn on the high beam.
6. Operate the rear defog function.
7. Hold the OK button on the warning message page.

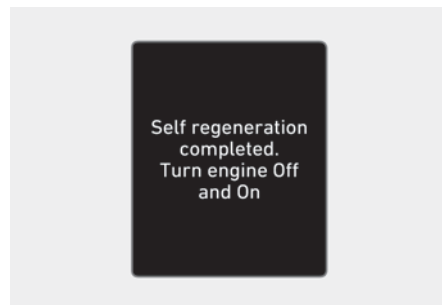

8. Turn off and turn on the engine again.

### Not Operating Condition

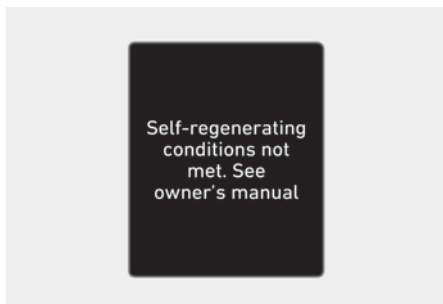

Under below condition, Diesel Catalyst regeneration process may be interrupted. (Engine RPM drops to idle state)

- Engine overheat or insufficient warm-up
- Shift lever change to D or R state
- Acceleration pedal is pressed
- Movement of Vehicle (Vehicle speed over 0)

#### Service Check

If the DPF indicator change from illuminates to blink or Engine Check Lamp(MIL) illuminates with DPF indicator in spite of the procedure, please visit an authorized Hyundai dealer and then check the Diesel Catalyst and engine system including oil level inspection.

Please note that the vehicle acceleration is limited to protect engine system when DPF indicator blinks or Engine Check Lamp(MIL) illuminates.

### Operating Self Regeneration Mode

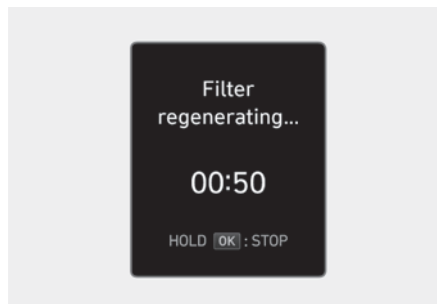

If the self regeneration mode starts, the message “Filter regenerating...” and the remaining time appears. It takes around 30~60 minutes.

#### Self Regeneration Mode Fail

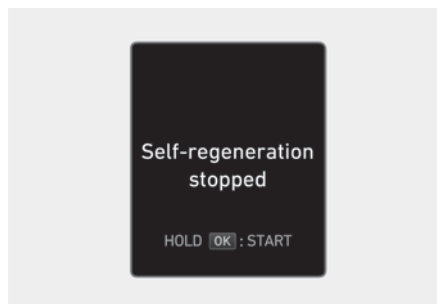

The regeneration operation could be canceled if the driver press the OK button firmly while operating the self regeneration process.

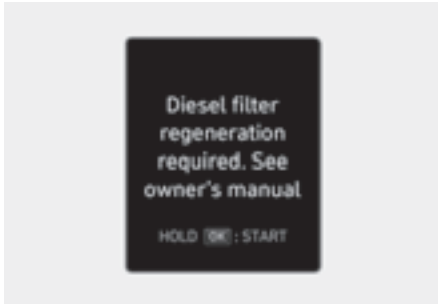

If the system still needs the self regeneration process after cancelling the operation, the warning message appears. (Diesel filter regeneration required.)

If the driver press the OK button firmly, it can restart the self regeneration mode again. (The Self regeneration conditions should be satisfied.)

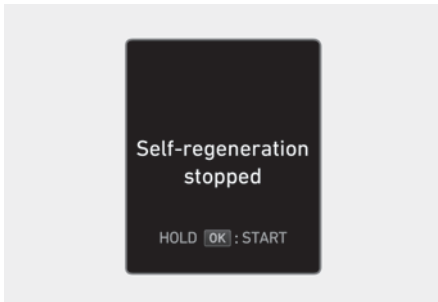

The self regeneration process stops if any of the self regeneration conditions is cancelled. If the self regeneration process is cancelled automatically, the system maintains "Self-regeneration stopped" message.

If the driver press the OK button firmly, it can restart the self regeneration mode again. (Self regeneration conditions should be satisfied.)

## Segment type

### Regeneration

The self regeneration procedure is conducted as follows:

1. Repeat key position at LOCK (or ACC) ? ON state 5 times. (within 30 seconds)
2. Start engine.
3. Monitor engine state: Within 20 seconds, engine RPM rise to about 2,000 and it continues for 30-60 minutes. After the end of regeneration, engine RPM drop to idle automatically.
4. Stop the engine (Key Off), wait for 20 seconds and restart the engine.
5. Check malfunction indicator turn out.

### CAUTION

Under below condition, Diesel Catalyst regeneration process may be interrupted. (Engine RPM drops to idle state)

- Engine overheat or insufficient warm-up
  - Shift lever change to D or R state
  - Acceleration pedal is pressed
  - Movement of Vehicle (Vehicle speed over 0)
-

 **WARNING**

If vehicle doesn't enter regeneration mode or if regeneration mode is interrupted, stop the engine (Key Off), wait for 20 seconds and retry the self regeneration procedure.

---

 **WARNING**

Self regeneration should be done only when DPF indicator illuminates. Frequent regeneration may cause engine oil dilution and shortening of Diesel Catalyst durability.

---

**Service Check**

If the DPF indicator change from illuminates to blink or Engine Check Lamp(MIL) illuminates with DPF indicator in spite of the procedure, please visit an authorised Hyundai dealer and then check the Diesel Catalyst and engine system including oil level inspection.

Please note that the vehicle acceleration is limited to protect engine system when DPF indicator blinks or Engine Check Lamp(MIL) illuminates.

